

PLEASE CHECK WWW.MOLEX.COM FOR LATEST PART INFORMATION

Part Number: [0353170224](#)
Status: **Active**
Overview: [minifit_jr](#)
Description: 4.20mm (.165") Pitch Mini-Fit® Header, Dual Row, Vertical, 2 Circuits, PA Polyamide (Nylon) 6/6 94V-2, Blue

Documents:

[3D Model](#) [RoHS Certificate of Compliance \(PDF\)](#)
[Drawing \(PDF\)](#)

Agency Certification

CSA LR19980
 UL E29179

General

Product Family PCB Headers
 Series [35317](#)
 Application Wire-to-Board
 Comments Current = 13A max. per circuit when header is mated to a receptacle loaded with [45750](#) Mini-Fit Plus HCS™ Crimp Terminal Crimped to to 16 AWG wire. . See Molex product specification PS-45750-001 for additional current de-rating information.

Overview [minifit_jr](#)
 Product Name Mini-Fit®

Physical

Breakaway No
 Circuits (Loaded) 2
 Circuits (maximum) 2
 Color - Resin Natural
 Durability (mating cycles max) 30
 First Mate / Last Break No
 Flammability 94V-2
 Glow-Wire Compliant No
 Guide to Mating Part No
 Keying to Mating Part None
 Lock to Mating Part Yes
 Material - Plating Mating Tin
 Material - Plating Termination Tin
 Material - Resin Nylon
 Number of Rows 2
 Orientation Vertical
 PC Tail Length (in) 0.138 In
 PC Tail Length (mm) 3.50 mm
 PCB Locator Yes
 PCB Retention None
 PCB Thickness Recommended (in) 0.062 In
 PCB Thickness Recommended (mm) 1.60 mm
 Packaging Type Bag
 Pitch - Mating Interface (in) 0.165 In
 Pitch - Mating Interface (mm) 4.20 mm
 Polarized to PCB No
 Shrouded Partial
 Stackable No
 Surface Mount Compatible (SMC) No

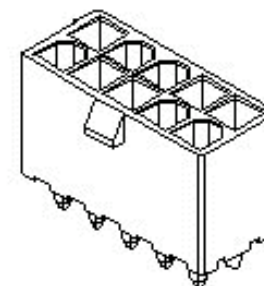

image - Reference only

Series

EU RoHS

ELV and RoHS Compliant
REACH SVHC
 Not Reviewed
Halogen-Free Status

China RoHS



Halogen-Free

Need more information on product environmental compliance?

Email productcompliance@molex.com
 For a multiple part number RoHS Certificate of Compliance, [click here](#)

Please visit the [Contact Us](#) section for any non-product compliance questions.

Search Parts in this Series

[35317Series](#)

Mates With

[5557](#) Mini-Fit Jr.™ Receptacle Housing

Temperature Range - Operating -40°C to +105°C
Termination Interface: Style Through Hole

Electrical

Current - Maximum per Contact 13A
Voltage - Maximum 250V

Material Info

Reference - Drawing Numbers

Packaging Specification PK-35317-001
Product Specification RPS-35317-001
Sales Drawing SD-35317-001

This document was generated on 05/24/2010

PLEASE CHECK WWW.MOLEX.COM FOR LATEST PART INFORMATION

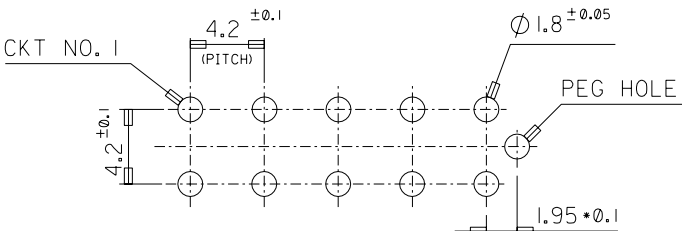
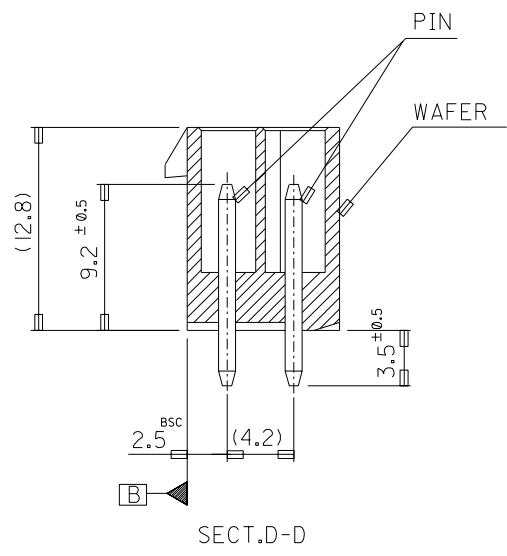
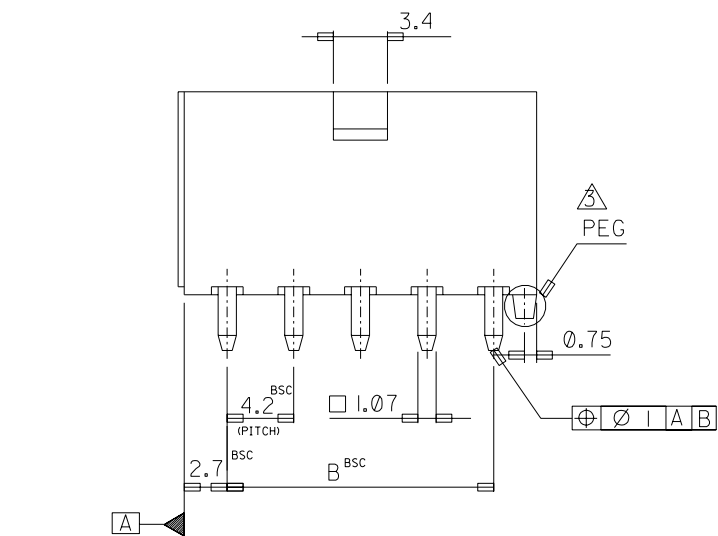
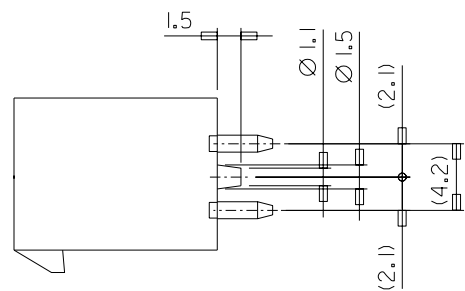
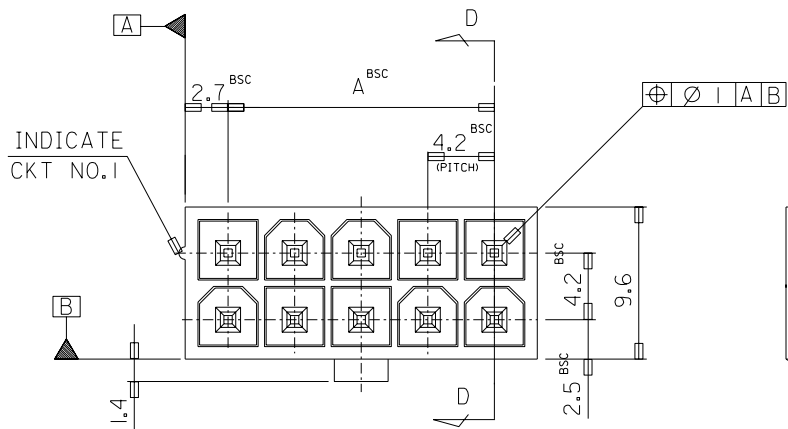

RECOMMENDED P.C.BOARD PATTERN

REVISED
KOR2003-0259
K.S.KIM 2003.5.23
J.K.OH
C.W.LEE

C

NOTES

1. WHEN MATED WITH 5557-NR TO BE SURELY LOCKED.
2. MATERIAL: WAFER — NYLON66 UL94V-0
NYLON66 UL94V-2
PIN — BRASS(TIN PLATED)

△ MOLD PEG IS 35317-***3*, -***4* ONLY.

LEGEND

35317 - ** * *
 COLOR - 0:NATURAL
 1:BLACK
 2:RED
 3:YELLOW
 4:BLUE
 6:GREEN
 7:BROWN
 1:NYLON66 UL94V-0
 2:NYLON66 UL94V-2
 3:NYLON66 UL94V-0(WITH PEG)
 4:NYLON66 UL94V-2(WITH PEG)
 CKT

46.2	3531724**	35317 -24**	24
42.0	3531722**	-22**	22
37.8	3531720**	-20**	20
33.6	3531718**	-18**	18
29.4	3531716**	-16**	16
25.2	3531714**	-14**	14
21.0	3531712**	-12**	12
16.8	3531710**	-10**	10
12.6	3531708**	-08**	8
8.4	3531706**	-06**	6
4.2	3531704**	-04**	4
—	3531702**	35317 -02**	2
A	Material No.	ENG. NO.	CIRCUIT

3:1 X
D.J.KIM 1993.05.01
J.K.OH
C.W.LEE

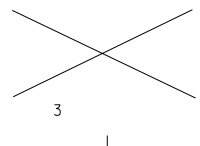

NEW MINIFIT CONN.
WAFER ASS'Y