

MATERIAL NUMBER	ENGINEERING NUMBER	MATERIAL NUMBER ON TAPE	ENGINEERING NUMBER ON TAPE	STUD SIZE	"S" ±.005/0.03	"D" MAX	"H" ±.020/0.50	"L" MAX
191640060	SC-228-04	191640936	SC-228-04T	#4	.126/3.20	.39/9.9	4.69/11.91	1.39/35.1
191640061	SC-228-06	191640937	SC-228-06T	#6	.146/3.71	.39/9.9	4.69/11.91	1.39/35.1
191640062	SC-228-08	191640938	SC-228-08T	#8	.173/4.39	.39/9.9	4.69/11.91	1.39/35.1
191640063	SC-228-10	191640939	SC-228-10T	#10	.198/5.03	.39/9.9	4.69/11.91	1.39/35.1
191640065	SC-230-10	191640316	SC-230-10T	#10	.198/5.03	.54/13.7	3.02/7.67	1.55/39.4
191640066	SC-230-14	191640317	SC-230-14T	1/4	.265/6.73	.54/13.7	3.02/7.67	1.55/39.4
191640067	SC-230-56	191640318	SC-230-56T	5/16	.328/8.33	.54/13.7	3.02/7.67	1.55/39.4
191640068	SC-240-38	191640857	SC-240-38T	3/8	.390/9.91	.60/15.2	3.85/9.78	1.55/39.4
191640058	SC-201-12	---	---	1/2	.515/13.08	.76/19.3	---	1.87/47.5

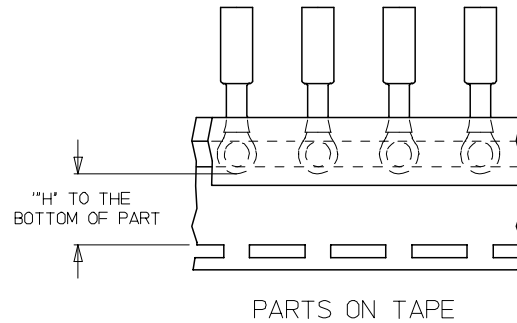
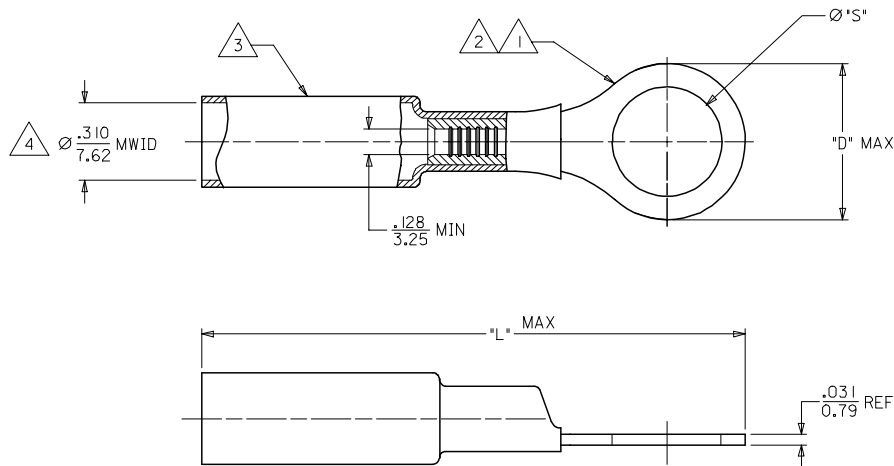

SALES DRAWING

NOTES:

- ①. TERMINAL MATERIAL: COPPER ALLOY
- ②. FINISH: ELECTRO TIN PLATE.
- ③. INSULATION MATERIAL: HEAT SHRINKABLE TUBING WITH HOTMELT ADHESIVE INNER LINER. COLOR: YELLOW
- ④. MWID = MAXIMUM WIRE INSULATION DIAMETER.
- ⑤. PARTS ON TAPE DOUBLE SPACED.

ADD MAT'L NUMBER EC NO: ETC2005-0208 DRW:NDMRYLCK 2005/05/31 CHKD:RDEROSS 2005/05/31 APPR:JPANLJCK 2005/05/31	QUALITY SYMBOLS	GENERAL TOLERANCES (UNLESS SPECIFIED)		DIMENSION STYLE IN/MM	SCALE ---	DESIGN UNITS INCH	THIRD ANGLE PROJECTION
	▽=0	mm	INCH	DRAWN BY BENDERLE	DATE 2002/09/10	TITLE RING TONGUE TERMINAL PERMA-SEAL NIAC 12-10 AWG	
	▽=0	4 PLACES ± ---	± ---	CHECKED BY HBEITZEL	DATE 2002/09/10	MOLEX INCORPORATED	
	▽=0	3 PLACES ± ---	± ---	APPROVED BY RDEROSS	DATE 2002/09/10	MATERIAL NO. SEE CHART	DOCUMENT NO. SD-19164-041
REV	DESCRIPTION	DRAFT WHERE APPLICABLE MUST REMAIN WITHIN DIMENSIONS		SIZE C		THIS DRAWING CONTAINS INFORMATION THAT IS PROPRIETARY TO MOLEX INCORPORATED AND SHOULD NOT BE USED WITHOUT WRITTEN PERMISSION	