

Applications

- VSAT Ground Terminal
- Millimeter wave Communications

Product Features

- RF Frequency: 18.3 to 20.2 GHz
- Internal dual band LO Sources
- 7.9 to 9.1 GHz and 9.9 to 11.1 GHz
- IF Frequency: 950 to 1950 MHz
- Conversion Gain: 8.5 dB
- Single Side Band Noise Figure: 6.5 dB
- Input IP3: -8 dBm
- Differential $\div 4$ VCO output for use by external PLL
- Single +5V supply operation
- Bias 5.0 V, 305 mA
- Package Dimensions: 5.0 x 6.0 x 0.85mm

General Description

The TriQuint TGC4408-SM is a low cost Ku band downconverter. It provides in a single package a dual band VCO, a subharmonic mixer, and all the associated gain stages required to integrate the VCO and the mixer.

The TGC4408-SM provides a differential signal at 1/4th the VCO frequency for use in a phase-locked loop.

The subharmonic mixer is manufactured using TriQuint's pHEMT process; the VCO and the prescaler are manufactured using TriQuint's HBT process.

The TGC4408-SM is available as a single surface mount 32 lead 5x6 QFN package and is ideally suited for VSAT ground terminals and millimeter wave communication receivers.

Lead-free and RoHS compliant.

Evaluation Boards are available upon request.

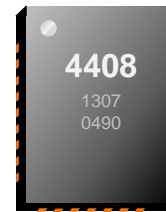

32-pin 5x6mm QFN package

Functional Block Diagram

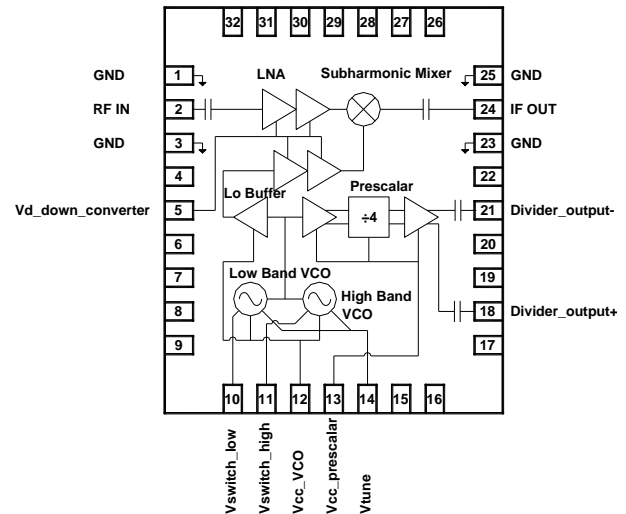

Pin Configuration

Pin #	Function Label
1,3,23,25	GND
2	RF IN
5	Vd_down_converter
10	Vswitch_low
11	Vswitch_high
12	Vcc_VCO
13	Vcc_prescaler
14	V_tune
18	Divider_output+ (LO/4)
21	Divider_output- (LO/4)
24	IF OUT
4,6,7,8,9,15,16,17,19,20,22,26 thru 32 thru 32	N/C

Ordering Information

Part No.	ECCN	Description
TGC4408-SM	EAR99	18 to 20 GHz Block Downconverter
Standard T/R size = 500 pieces on a 13" reel		

Specifications

Absolute Maximum Ratings

Parameter	Rating
Storage Temperature	-40 to 125°C
Mounting Temperature (30 Seconds)	260 °C
Channel Temperature, Tch	200 °C
RF Input Power, 50Ω, T = 25°C	10 dBm
Vcc_VCO	+5.5V
Vcc_Prescaler	+5.5 V
Vtune	+5.5 V
Vswitch_low, Vswitch_high	Vcc + 0.5 V
Current, Vcc_VCO	120 mA
Current, Vcc_Prescaler	140 mA
Current, Vd_down_converter	155 mA
Current, Vtune	0.5 mA
Current, Vswitch_low, Vswitch_high	4 mA
Power Dissipation, Pdiss	2.28 W

Operation of this device outside the parameter ranges given above may cause permanent damage.

Recommended Operating Conditions

Parameter	Min	Typ	Max	Units
Operating Temp. Range	-40		+85	°C
Vcc_VCO		5.0		V
Vcc_Prescaler		5.0		V
Vtune	1	2.1	4.0	V
Vd_down_converter		5.0		V
Current, Vcc_VCO		100		mA
Current, Vcc_Prescaler		105		mA
Current, Vcc_VCO + Vcc_prescaler		205	240	mA
Current, Vd_down_converter		100	135	mA
T _J (for >10 ⁵ hours MTF)			175	°C

Electrical specifications are measured at specified test conditions. Specifications are not guaranteed over all recommended operating conditions.

Specifications

Electrical Specifications

Test conditions unless otherwise noted: V_{cc_VCO} , $V_{dd_downconverter}$, $V_{dd_prescaler} = 5.0V$, $25^{\circ}C$.

Parameter	Conditions	Min	Typ	Max	Units
Supply Voltage		4.8	5	5.2	V
Supply Current			305		mA
Input Frequency		18.3		20.2	GHz
Output Frequency		950		1950	MHz
Return Loss @ RF IN (17.5 – 21 GHz)		7	10		dB
VCO Frequency – Low Band	Vtune +1V to +4V	8.55	8.67	8.76	GHz
VCO Frequency – High Band	Vtune +1V to +4V	10.45	10.57	10.66	GHz
VCO Tune Voltage (Vtune)		1	2.1	4	V
VCO Tuning Sensitivity -Low Band		125	260	375	MHz/V
VCO Tuning Sensitivity - High Band		125	260	375	MHz/V
Pushing			45	70	MHz/V
VCO Select 1,2		0		5	V
LO/4 Prescaler Range		2.09		2.72	GHz
LO/4 Output Power			-4		dBm
Phase Noise @ 10 KHz offset			-73		dBc/Hz
Phase Noise @ 100 KHz offset			-99		dBc/Hz
Phase Noise @ 1 MHz offset			-126		dBc/Hz
Phase Noise @ 10 MHz offset			-136		dBc/Hz

Specifications

Electrical Specifications

Test conditions unless otherwise noted: V_{cc_VCO} , $V_{dd_downconverter}$, $V_{dd_prescaler} = 5.0V$, $25^\circ C$

Parameter	Conditions	Min	Typ	Max	Units
Return Loss @ IF OUT (950 – 1950 MHz)	Using application circuit	10	13		dB
Conversion Gain		6.4	10.0	14.1	dB
SSB Noise Figure			6.5	8	dB
Out of Band Spurious: (2LO @ RF) (2LO @ IF) (LO/4 @ IF)			-35 -45 -60		dBm dBm dBm
Isolation: (LO @ IF)			-7		dBm
P1dB Compression Point		-17	-14		dBm
Third Order Input Intercept Point (IIP3)		-10	-6		dBm

Specifications

Thermal and Reliability Information

Parameter	Conditions	Rating
Thermal Resistance, θ_{JC} , measured to back of package	Tbase = 70 °C	$\theta_{JC} = 41.2 \text{ }^\circ\text{C/W}$
Channel Temperature (Tch), and Median Lifetime (Tm)	Tbase = 70 °C, Vd = 5V, Id = 305 mA, Pdiss = 1.5 W	Tch = 133 °C Tm = 3.9E+7 Hours

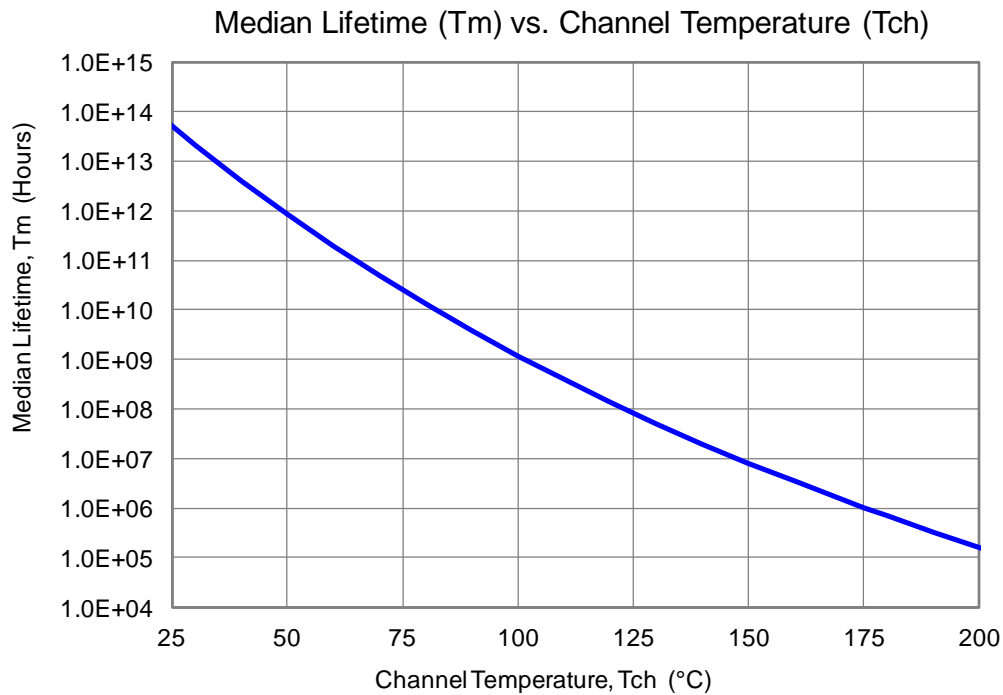

Typical Performance

CG vs. Frequency vs. Temperature
Low Band LO: 8.67 GHz

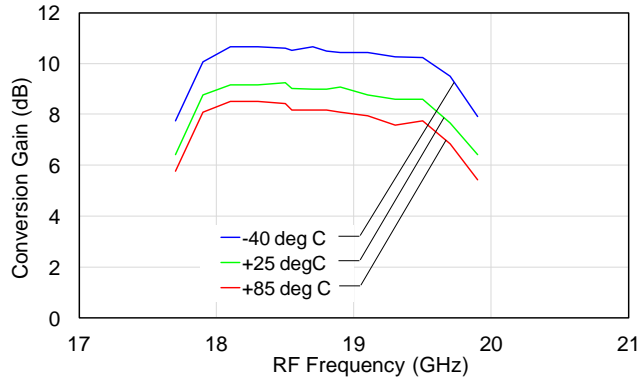

CG vs. Frequency vs. Temperature
High Band LO: 10.57 GHz

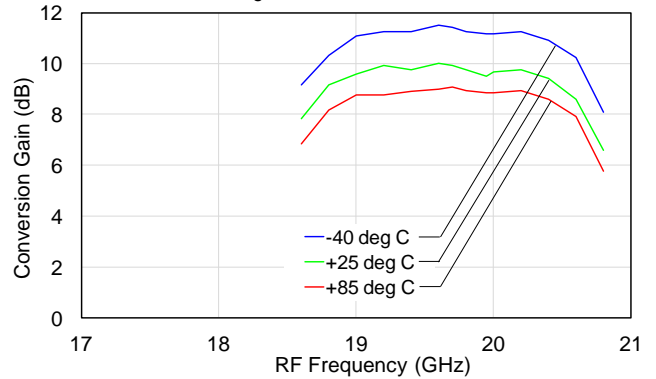

Input P1dB vs. Frequency vs. Temperature
Low Band LO

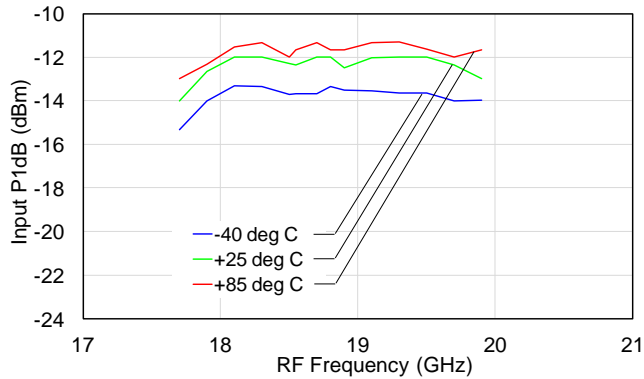

Input P1dB vs. Frequency vs. Temperature
High Band LO

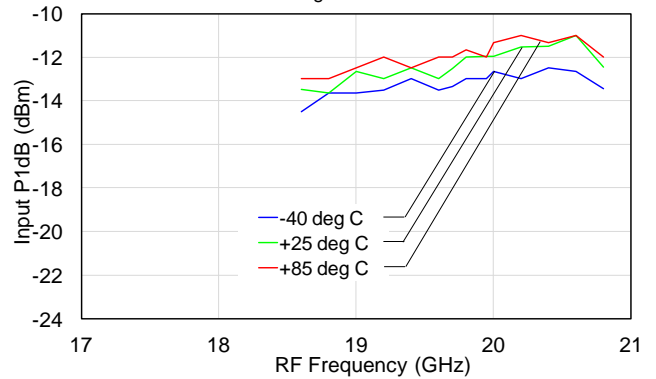

Input IP3 vs. Frequency vs. Temperature
Low Band LO

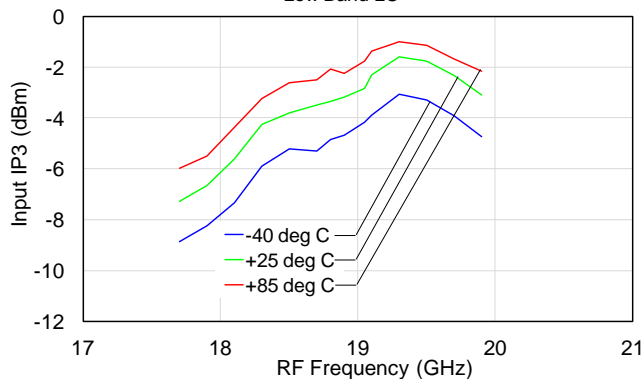

Input IP3 vs. Frequency vs. Temperature
High Band LO

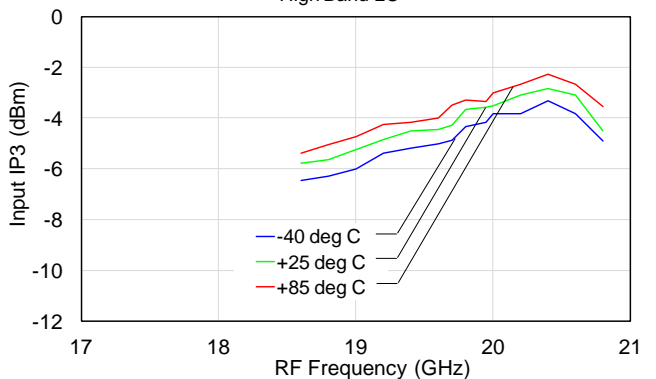

Typical Performance

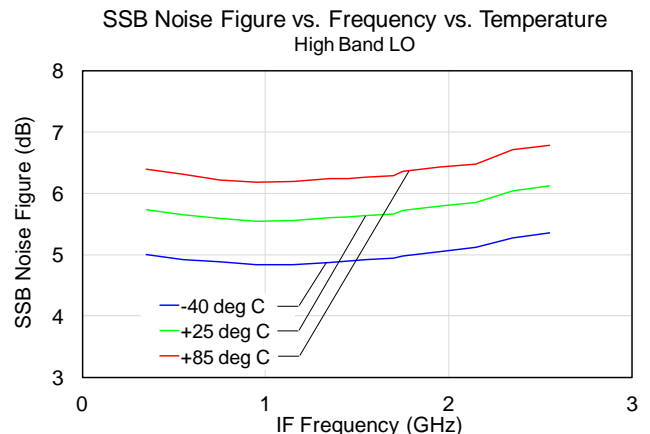
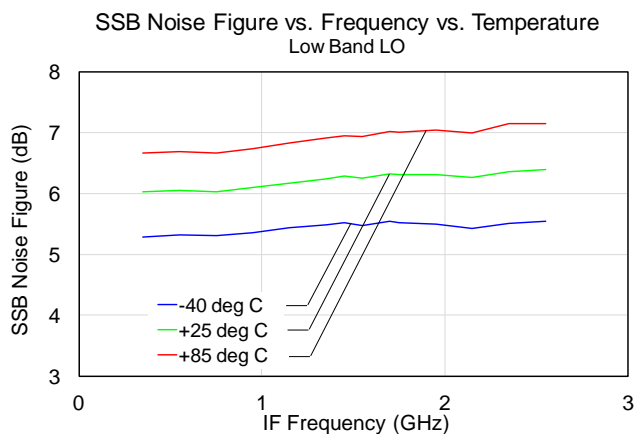
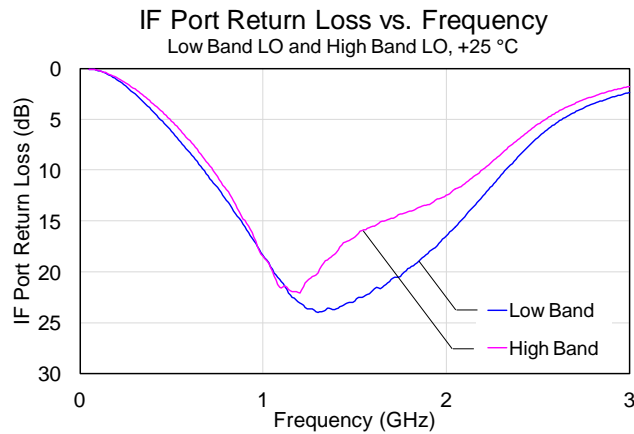
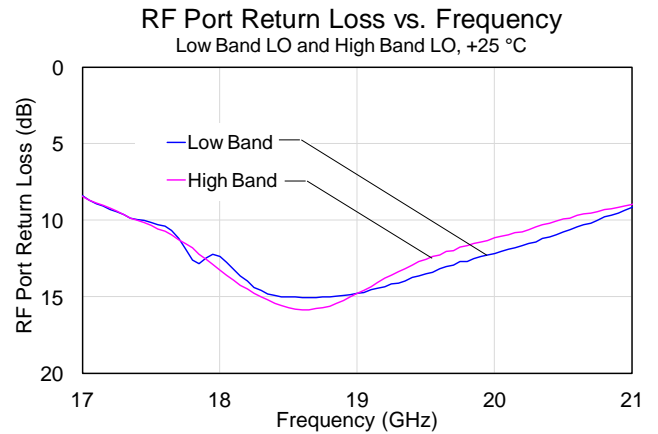
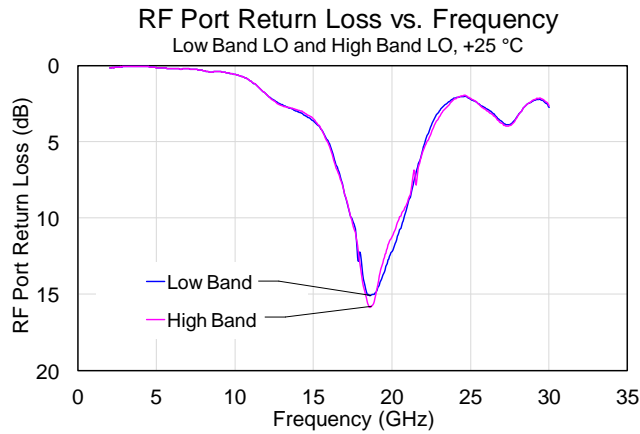

Typical Performance

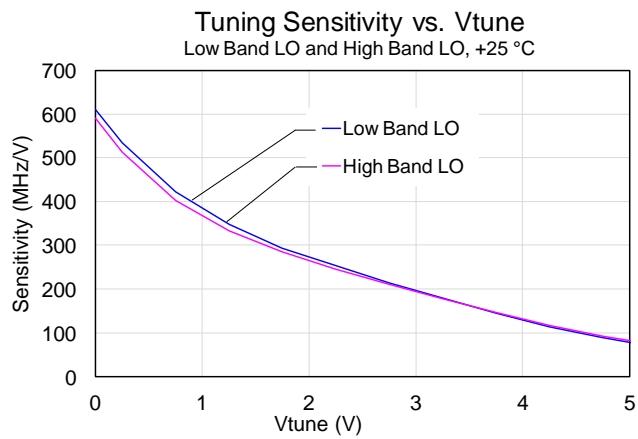
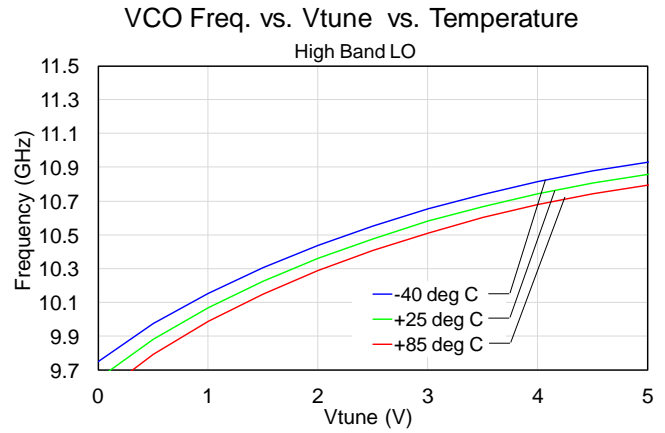
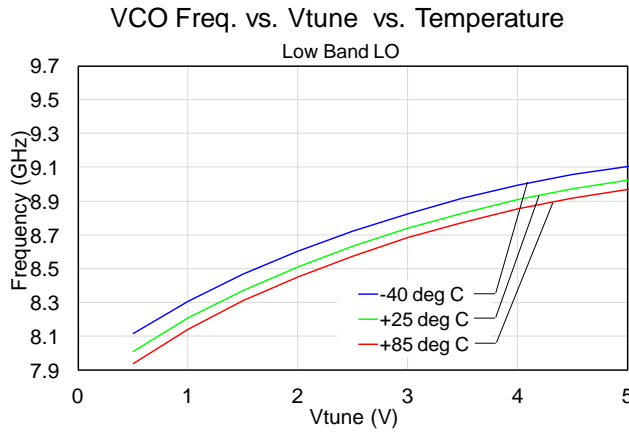

Typical Performance

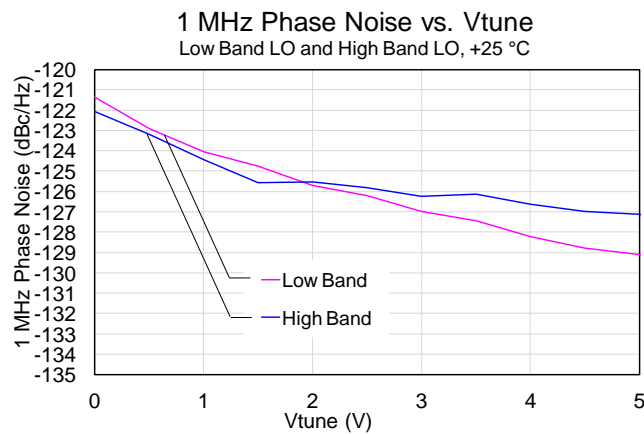
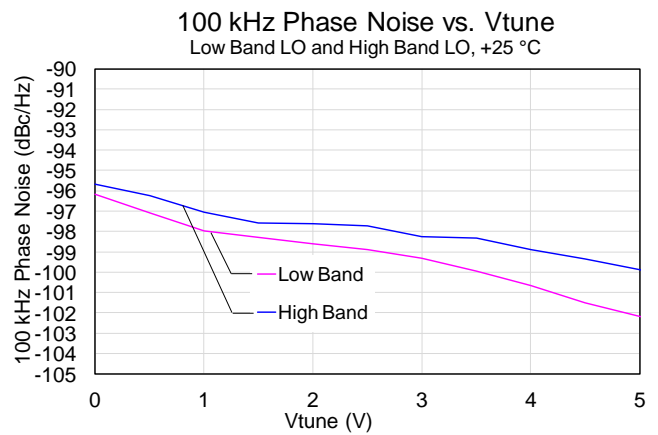
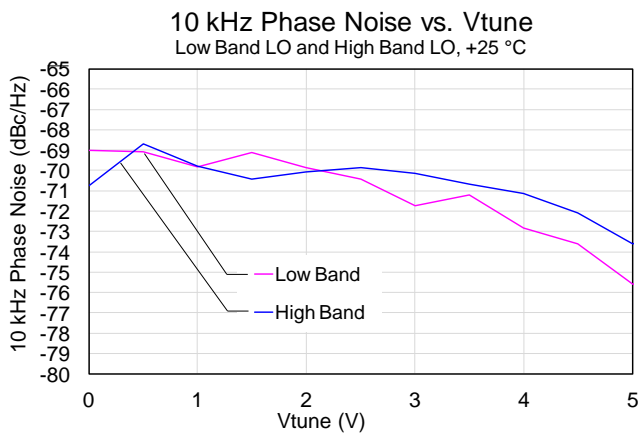
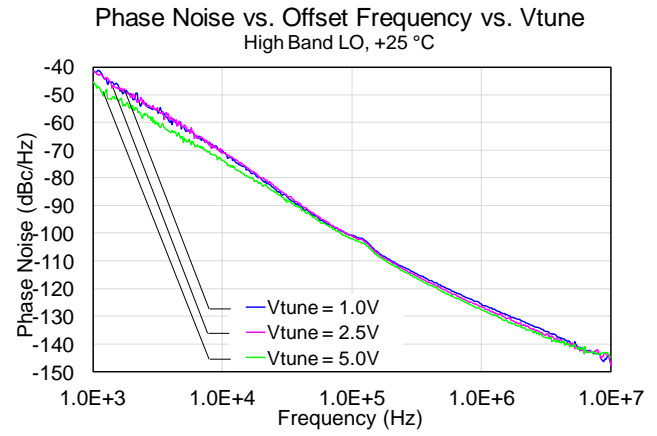
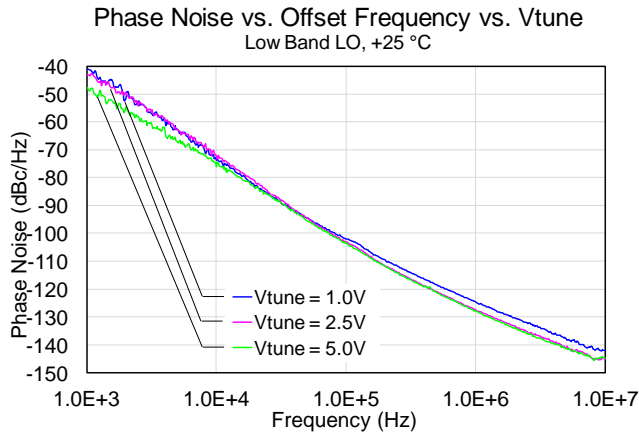

Typical Performance

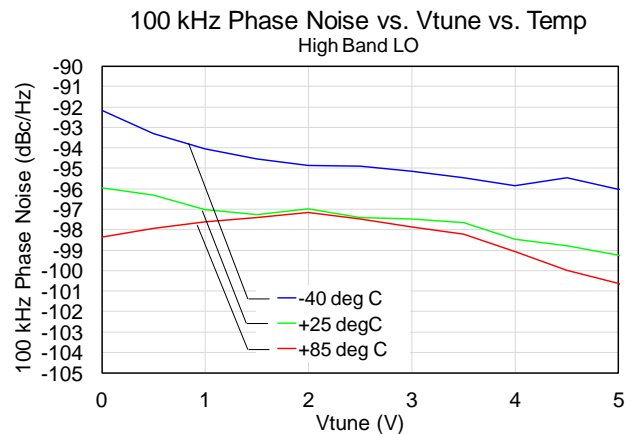
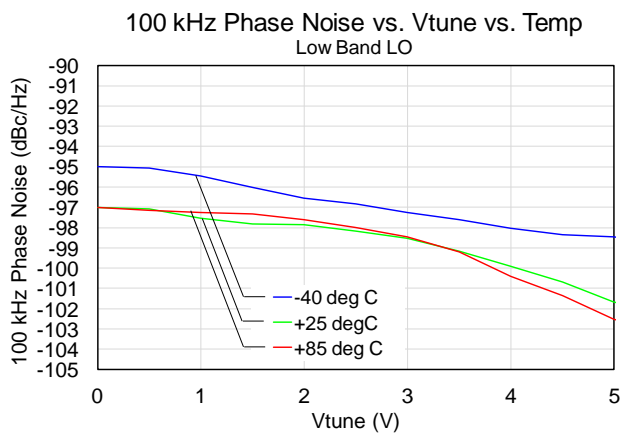
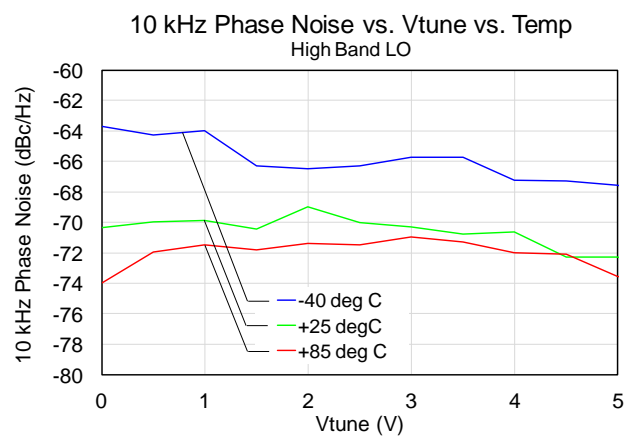
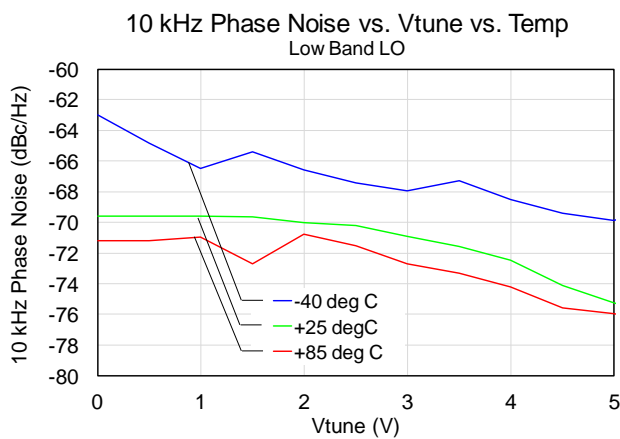
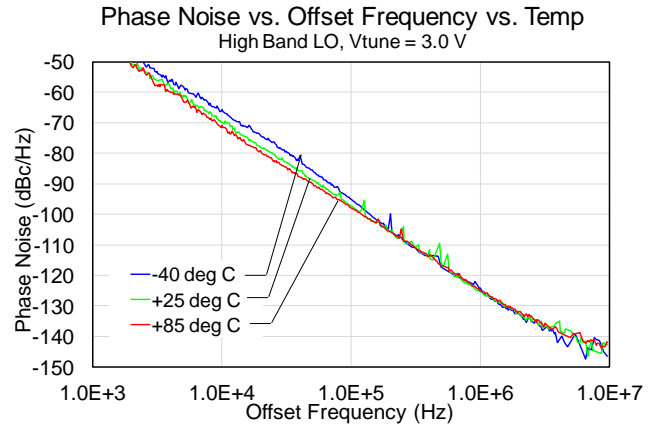
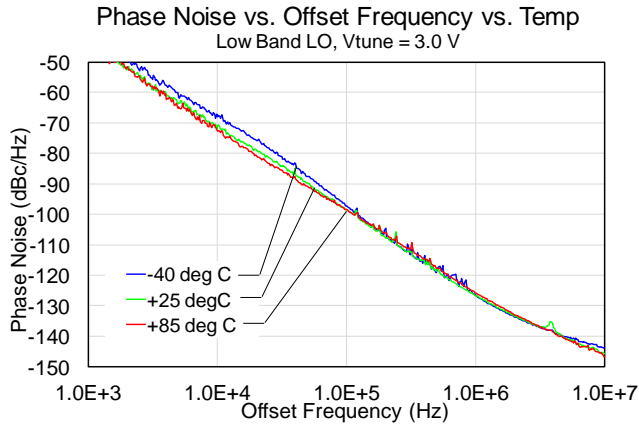

Typical Performance

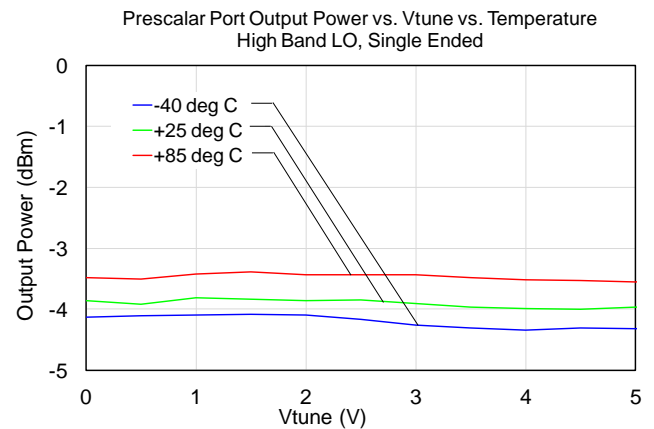
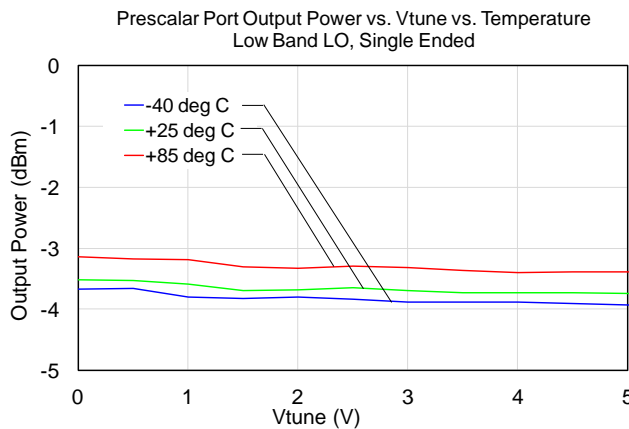
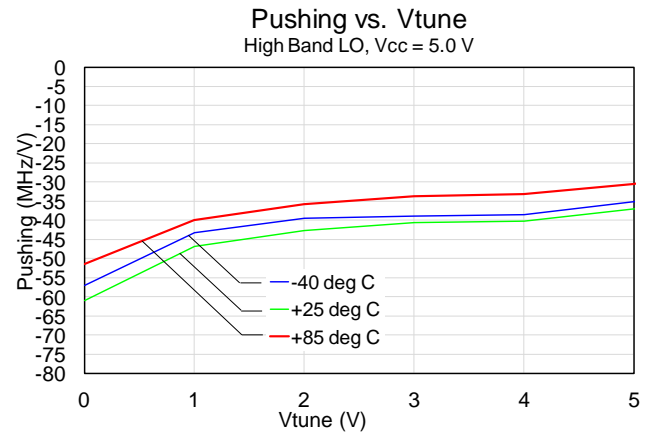
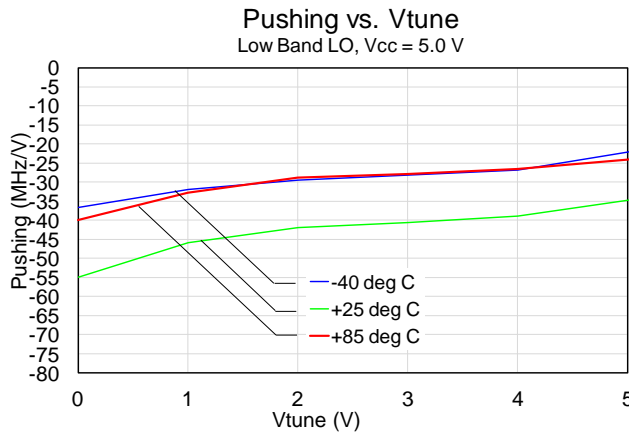
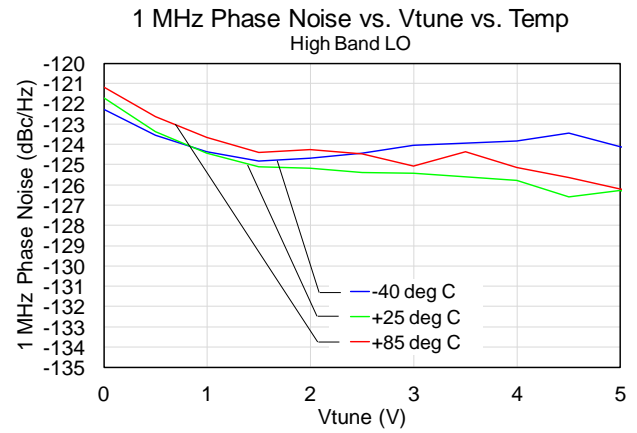
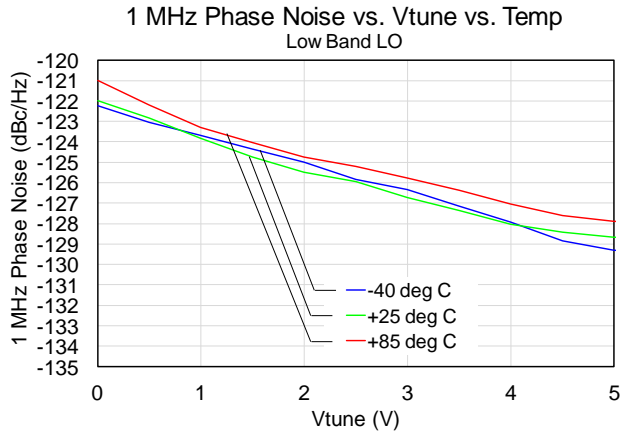

Typical Performance

Spur Tables

Spur tables are $N \times f_{RF} - M \times f_{LO}$ mixer spurious products for -36 dBm RF input power.

(Subharmonic mixer, IF is at $1RF \times 2LO$)

RF = 18.3 GHz @ -36 dBm

LO = 8.67 GHz

All values in dBc below the IF output power level.

		M x f _{LO}					
		0	1	2	3	4	5
N	0	--	-19	34	4	10	22
	1	30	41	0	40	44	--
	2	--	--	--	--	--	--
	3	--	--	--	--	--	--

RF = 18.3 GHz @ -36 dBm

LO = 8.67 GHz

All values in dBc below the IF output power level.

		M x f _{LO} /4										
		1	2	3	4	5	6	7	8	9	10	11
N	0	14	57	34	-19	52	50	34	34	50	44	46
	1	--	--	--	--	--	--	--	0	--	--	--

Pin Description

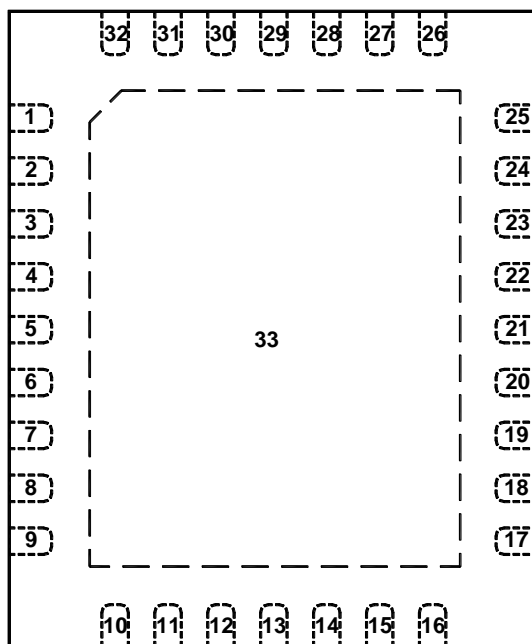

Pin	Symbol	Description
1,3,23,25	GND	GND
2	RF IN	RF Input, matched to 50 ohms
5	Vd_down_converter	+5V supply for mixer
10	Vswitch_low	+5V on pin 10 and 0 V on pin 11 enables the 8.675 GHz VCO
11	Vswitch_high	+5V on pin 11 and 0 V on pin 10 enables the 10.575 GHz VCO
12	Vcc_VCO	+5V supply for VCO
13	Vcc_prescaler	+5V supply for prescaler
14	V_tune	Adjustment voltage for the LO frequency. Vtune is common to both VCOs.
18	Divider_output+ (LO/4)	Divider_output+ (LO/4). 50 Ohm impedance. Differential output of the VCO frequency divided by 4 for use by an external phase locked loop. May be left unterminated for single ended applications.
21	Divider_output- (LO/4)	Divider_output- (LO/4).). 50 Ohm impedance. Differential output of the VCO frequency divided by 4 for use by an external phase locked loop. May be left unterminated for single ended applications.
24	IF OUT	IF Output, requires external matching to 50 ohm impedance. See 'Application Circuit'.
4,6,7,8,9,15, 16,17,19,20,22, 26 thru 32	N/C	No internal connection; can be grounded on PCB or left open
33	GND	Backside Paddle. Multiple vias should be employed to minimize inductance and thermal resistance; see Mounting Configuration on page 17 for suggested footprint.

Application Circuit

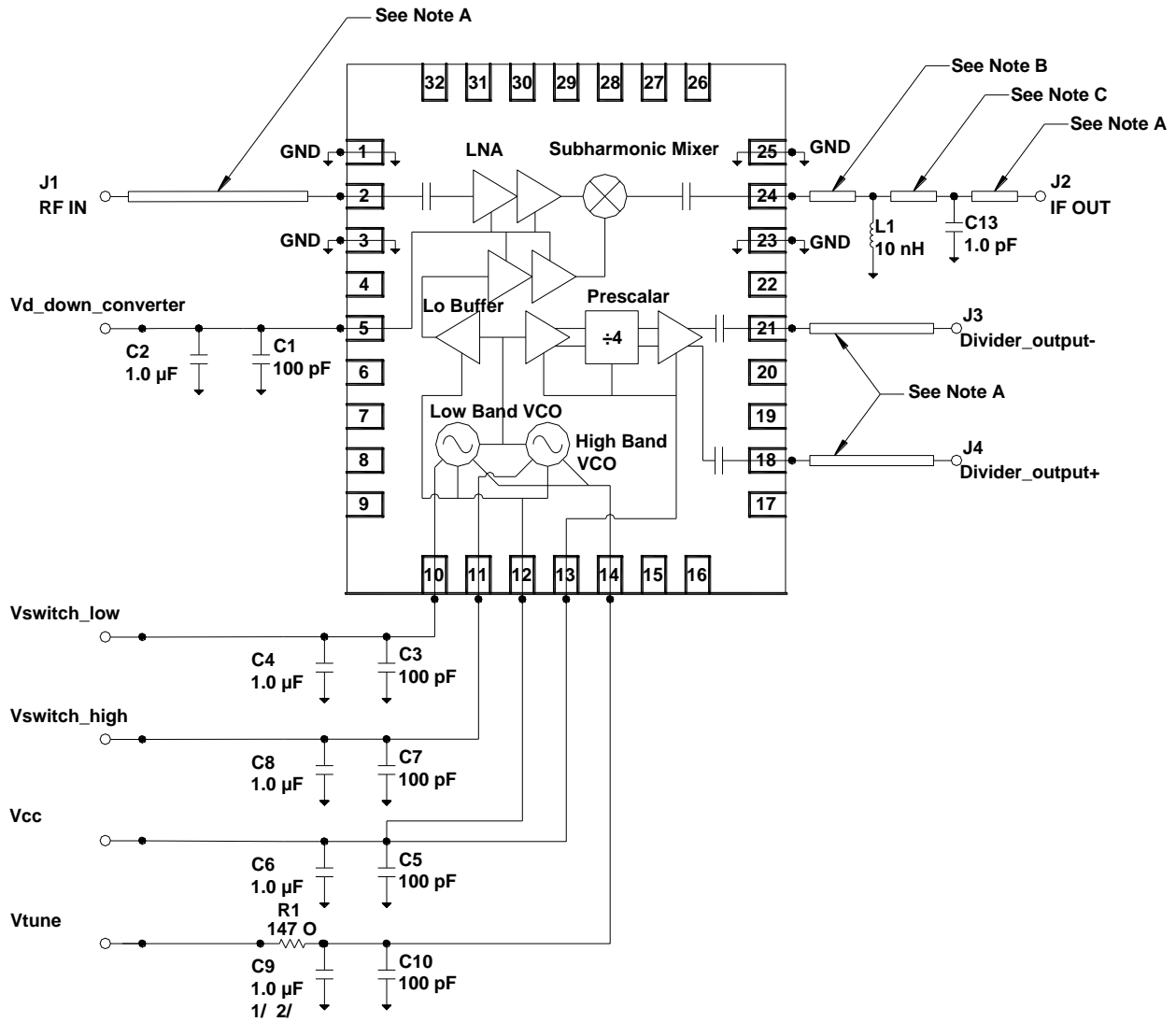

Note A: 50 Ω microstrip transmission line
 Note B: 104 Ω microstrip transmission line, 6.0° at 950 MHz
 Note C: 104 Ω microstrip transmission line, 5.1° at 950 MHz

Application Circuit

PC Board Layout

Single core layer board using 0.020" thick Rogers RO4003, $\epsilon_r = 3.38$. Metal layers are 0.5-oz copper with patterning on top layer as shown. Bottom layer is unpatterned and is the RF and DC ground. For further technical information, refer to the [TGC4408-SM](#) Product Information page.

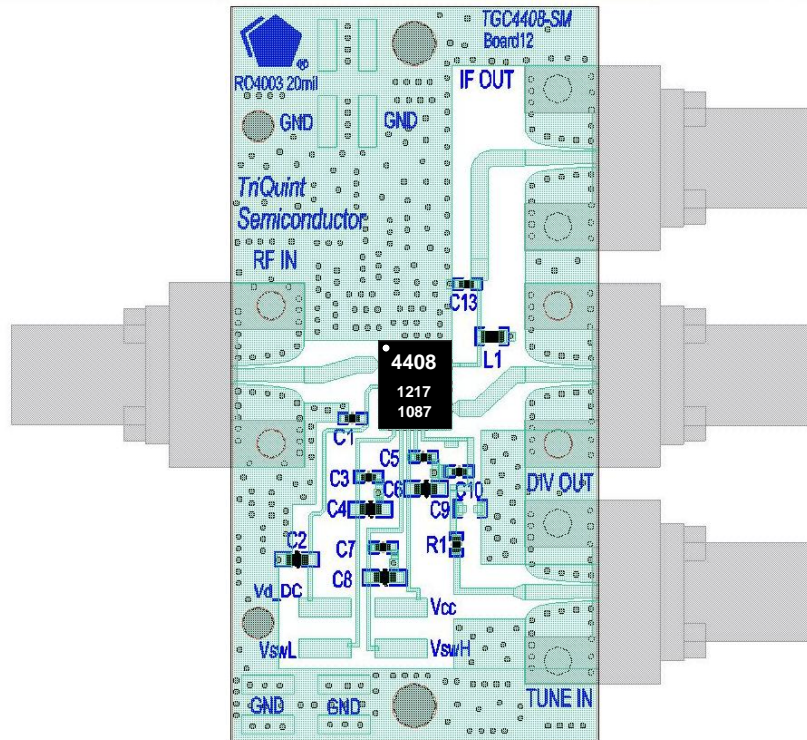

Bill of Material

Ref Des	Value	Description	Manufacturer	Part Number
C1, C3, C5, C7, C10	100 pF	Cap, 0402, 50 V, 5%, C0G SMD	various	
C2, C4, C6, C8	1.0 μ F	Cap, 0603, 25 V, 10%, X5R SMD	various	
C9 1/	1.0 μ F	Cap, 0603, 25 V, 10%, X5R SMD 1/	various	
C9 2/		NO POP 2/		
C13	1.0 pF	Cap, 0402, 25 V, ± 0.25 pF, C0G SMD	various	
R1	147 Ω	Res, 0402, 0.06 W, 5%, SMD	various	
L1	10 nH	Ind, 0603, SMD	Coilcraft	0603CS-10NXJ
RF IN, IF OUT, DIV OUT, TUNE IN	2.92mm or SMA RF connector	End Launch Connector	Southwest Microwave	1092-02A-5 or 292-05A-5
	100 pF	Cap, 0402, 50 V, 5%, C0G SMD	Various	

1/ When using fixed voltage for Vtune
2/ When using PLL to set Vtune

Mechanical Information

Package Marking and Dimensions

All dimensions are in millimeters.

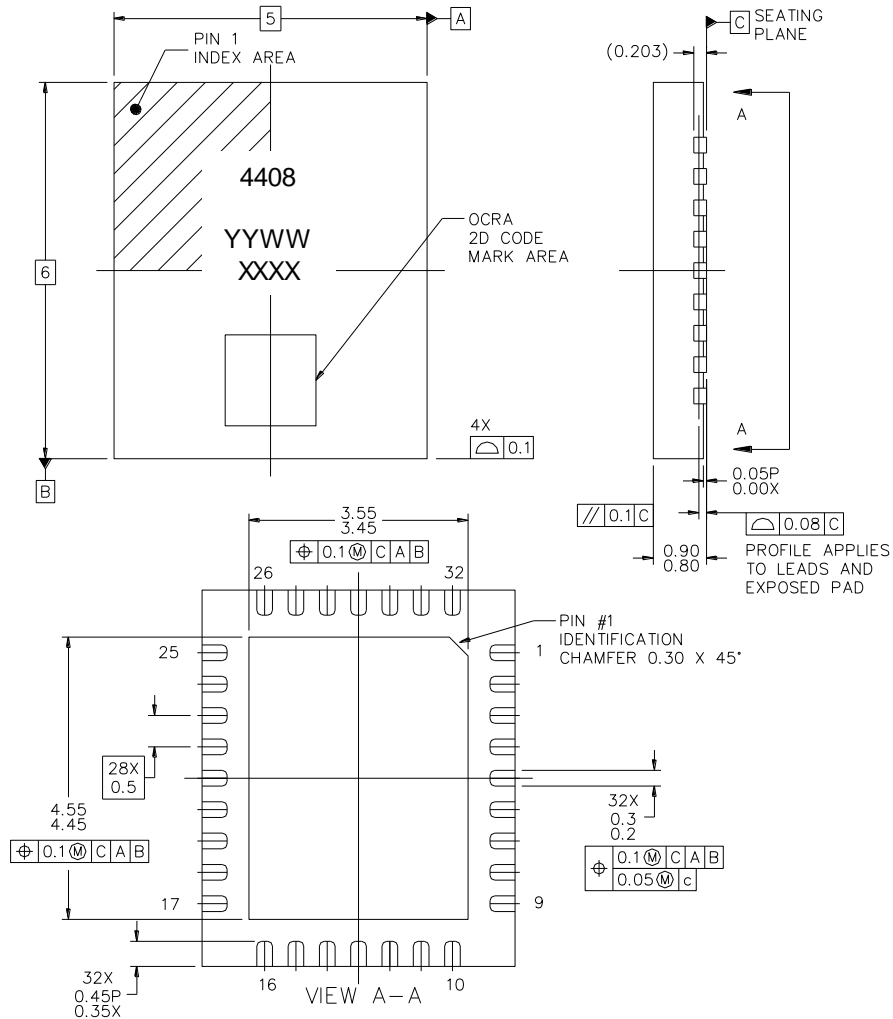

This package is lead-free/RoHS-compliant with a copper alloy base (CDA194), and the plating material on the leads is NiPdAu. It is compatible with both lead-free (maximum 260 °C reflow temperature) and tin-lead (maximum 245 °C reflow temperature) soldering processes.

The TGC4408-SM will be marked with the "4408" designator and a lot code marked below the part designator. The "YY" represents the last two digits of the year the part was manufactured, the "WW" is the work week, and the "XXXX" is an auto-generated number. The OCR-A 2D Code has four rows and is the 'XXXX' number, one digit per row.

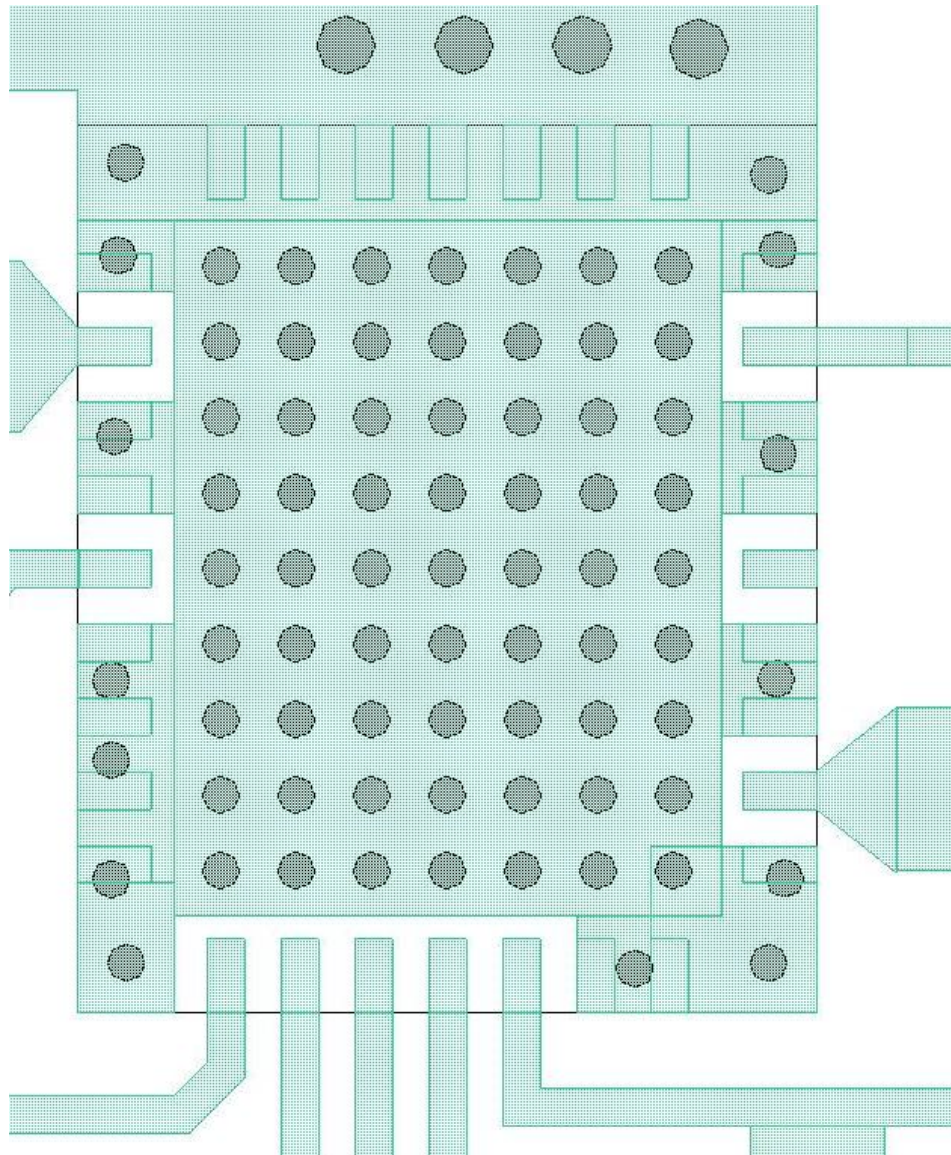
Mechanical Information**PCB Mounting Pattern****Notes:**

1. The pad pattern shown has been developed and tested for optimized assembly at TriQuint Semiconductor. The PCB land pattern has been developed to accommodate lead and package tolerances. Since surface mount processes vary from company to company, careful process development is recommended.
2. Ground vias are critical for the proper performance of this device. Vias should use a .35mm (#80 / .0135") diameter drill and have a final plated thru diameter of .25 mm (.010").

Tape and Reel Information

Tape and reel specifications for this part are also available on the TriQuint website in the “Application Notes” section.
 Standard T/R size = 500 pieces on a 13” reel.

MATERIAL		CAVITY (mm)				DISTANCE BETWEEN CENTERLINE (mm)		CARRIER TAPE (mm)	COVER TAPE (mm)
Vendor	Vendor P/N	Length (A0)	Width (B0)	Depth (K0)	Pitch (P1)	Length direction (P2)	Width Direction (F)	Width (W)	Width (W)
Advantek	ML0506-D	5.30	6.30	1.30	8.0	2.00	5.50	12.0	9.20

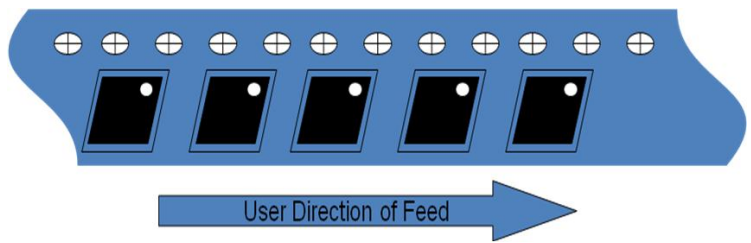
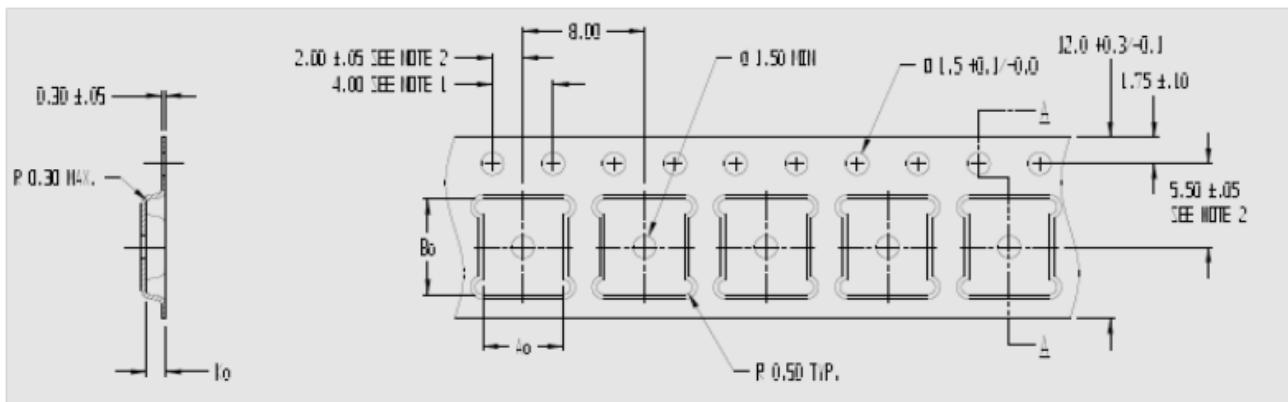

Product Compliance Information

ESD Information



Caution! ESD-Sensitive Device

ESD Rating: 1B
 Value: Passes ≥ 600 V and < 700 V min.
 Test: Human Body Model (HBM)
 Standard: JEDEC Standard JESD22-A114

ESD Rating: C4
 Value: Passes ≥ 500 V and < 700 V min.
 Test: Charged Device Model (CDM)
 Standard: JEDEC Standard JESD22-C101

ESD Rating: M2
 Value: Passes ≥ 100 V and < 200 V min.
 Test: Machine Model (MM)
 Standard: JEDEC Standard JESD22-A115

MSL Rating

Moisture Sensitivity Level (MSL) 3 at 260°C convection reflow per JEDEC standard IPC/JEDEC J-STD-020.

Solderability

Compatible with both lead-free (260 °C max. reflow temp.) and tin/lead (245 °C max. reflow temp.) soldering processes.

Package lead plating: NiPdAu

RoHS Compliance

This part is compliant with EU 2002/95/EC RoHS directive (Restrictions on the Use of Certain Hazardous Substances in Electrical and Electronic Equipment).

This product also has the following attributes:

- Lead Free
- Halogen Free (Chlorine, Bromine)
- Antimony Free
- TBBP-A (C₁₅H₁₂Br₄O₂) Free
- PFOS Free
- SVHC Free

Recommended Soldering Temperature Profile

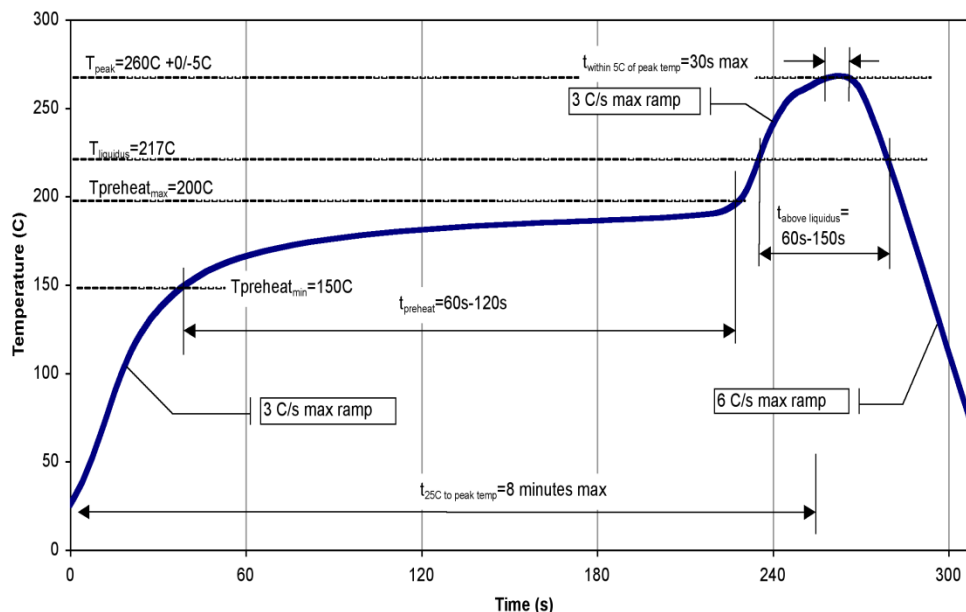

Contact Information

For the latest specifications, additional product information, worldwide sales and distribution locations, and information about TriQuint:

Web: www.triquint.com
Email: info-sales@tqs.com

Tel: +1.972.994.8465
Fax: +1.972.994.8504

For technical questions and application information:

Email: info-networks@tqs.com

Important Notice

The information contained herein is believed to be reliable. TriQuint makes no warranties regarding the information contained herein. TriQuint assumes no responsibility or liability whatsoever for any of the information contained herein. TriQuint assumes no responsibility or liability whatsoever for the use of the information contained herein. The information contained herein is provided "AS IS, WHERE IS" and with all faults, and the entire risk associated with such information is entirely with the user. All information contained herein is subject to change without notice. Customers should obtain and verify the latest relevant information before placing orders for TriQuint products. The information contained herein or any use of such information does not grant, explicitly or implicitly, to any party any patent rights, licenses, or any other intellectual property rights, whether with regard to such information itself or anything described by such information.

TriQuint products are not warranted or authorized for use as critical components in medical, life-saving, or life-sustaining applications, or other applications where a failure would reasonably be expected to cause severe personal injury or death.