

# Voltage Controlled Oscillator

ZX95-3360R+

50Ω 2120 to 3360 MHz

## The Big Deal:

- Wide Band
- Low Phase Noise
- High Power Output
- Robust design and construction
- Rigid unibody construction



CASE STYLE: GB956

## Product Overview:

The ZX95-3360R+ is a Voltage Controlled Oscillator, designed to operate from 2120 to 3360 MHz for satellite & radar applications. The ZX95-3360R+ is built using Mini-Circuits proven unibody construction (size of 1.20" x .75" x .46") which integrates the RF connectors with the case body to shield against unwanted signals and noise.

## Key Features

Feature	Advantages
Wide Band: from 2120 to 3360 MHz	The model's wide bandwidth makes it suitable for a wide variety of applications, such as: CATV, military, test equipment etc...
Low Phase Noise: -93 dBc/Hz typ at 10 kHz offset	Low phase noise improves system EVM (Error Vector Magnitude).
High Power Output, +9 dBm typ.	Reduces amplification requirements and improves immunity to external noise sources.
Good Pushing, 1.5 MHz/V typ.	Provides increased immunity against noisy DC lines and improves output frequency stability vs. variations in supply voltage.
Robust design and construction	Each internal component of the ZX95-3360R+ is bonded to the substrate, providing better immunity to microphonics and reduced phase hit.

Coaxial

# Voltage Controlled Oscillator

## ZX95-3360R+

Wide Band 2120 to 3360 MHz

### Features

- low phase noise, -93 dBc/Hz typ. @ 10kHz offset
- high power output, +9 dBm typ.
- low pushing, 1.5 MHz/V typ.
- protected by US patent 6,790,049

### Applications

- wireless communications
- satellite systems & radar
- military
- R&D & test equipment



CASE STYLE: GB956

Connectors	Model
SMA	ZX95-3360R-S+

**+RoHS Compliant**  
The +Suffix identifies RoHS Compliance. See our web site for RoHS Compliance methodologies and qualifications

### Electrical Specifications

MODEL NO.	FREQ. (MHz)		POWER OUTPUT (dBm)	PHASE NOISE dBc/Hz SSB at offset frequencies, kHz				TUNING				NON HARMONIC SPURIOUS (dBc)	HARMONICS (dBc)		PULLING pk-pk @12 dB (MHz)	PUSHING (MHz/V)	DC OPERATING POWER				
	Min.	Max.		Typ.	1	10	100	1000	VOLTAGE RANGE (V)		SENSI-TIVITY (MHz/V)		PORT CAP (pF)	3 dB MODULATION BANDWIDTH (MHz)			Typ.	Typ.	Max.	Typ.	Max.
	Typ.								Min.	Max.											
ZX95-3360R+	2120	3360	+9	-64	-93	-116	-136	0.5	18	77-123	25	170	-90	-20	-12	9	1.5	12	45		

### Maximum Ratings

Operating Temperature	-55°C to 85°C
Storage Temperature	-55°C to 100°C
Absolute Max. Supply Voltage (Vcc)	13V
Absolute Max. Tuning Voltage (Vtune)	20V
All specifications	50 ohm system

Permanent damage may occur if any of these limits are exceeded.



NOTE: When soldering the DC connections, caution must be used to avoid overheating the DC terminals. See Application Note [AN-40-10](#).

### Outline Drawing

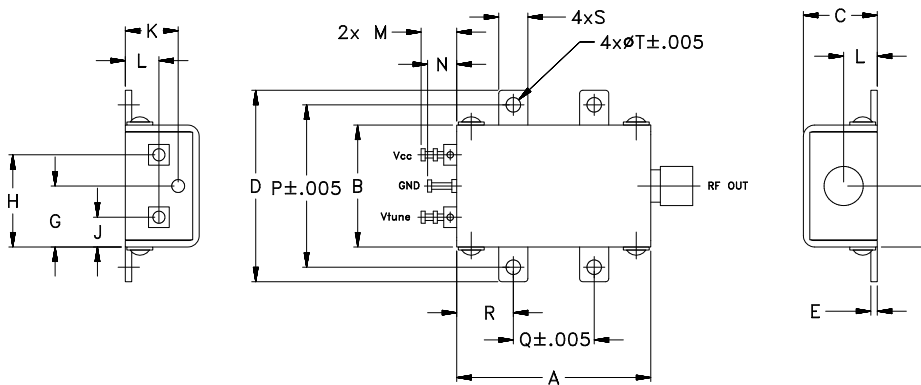

### Outline Dimensions (inch/mm)

A	B	C	D	E	F	G	H	J	K	L	M	N	P	Q	R	S	T	wt.
1.20	.75	.46	1.18	.04	.38	.38	.57	.18	.33	.21	.22	.18	1.00	.50	.35	.18	.106	grams
30.48	19.05	11.68	29.97	1.02	9.65	9.65	14.48	4.57	8.38	5.33	5.59	4.57	25.40	12.70	8.89	4.57	2.69	35.0

# Performance Data & Curves\*

# ZX95-3360R+

V TUNE	TUNE SENS (MHz/V)	FREQUENCY (MHz)			POWER OUTPUT (dBm)			I <sub>cc</sub> (mA)	HARMONICS (dBc)			FREQ. PUSH (MHz/V)	FREQ. PULL (MHz)	PHASE NOISE (dBc/Hz) at offsets				FREQ OFFSET (kHz)	PHASE NOISE at 2740 MHz (dBc/Hz)
		-55°C	+25°C	+85°C	-55°C	+25°C	+85°C		F2	F3	F4			1kHz	10kHz	100kHz	1MHz		
0.00	166.23	1958.5	1925.7	1899.2	10.09	9.89	9.52	39.92	-12.8	-14.5	-29.1	1.67	0.75	-64.33	-91.6	-112.8	-132.6	1.0	-67.20
0.50	137.16	2035.4	2008.8	1988.4	10.27	9.97	9.37	39.80	-15.0	-17.2	-34.0	1.47	2.27	-66.59	-94.2	-116.4	-136.4	2.5	-77.05
1.00	126.07	2102.1	2077.4	2059.5	10.35	9.69	9.27	39.75	-14.7	-54.2	-37.4	1.40	2.20	-66.33	-94.5	-116.6	-136.6	4.2	-82.00
2.00	114.51	2223.1	2200.9	2184.6	10.33	9.71	9.27	39.67	-22.2	-25.5	-42.6	1.48	3.88	-65.36	-93.8	-116.6	-136.9	7.1	-88.44
3.00	108.03	2334.2	2313.9	2297.7	10.35	9.57	9.04	39.51	-27.3	-28.6	-36.7	1.47	1.26	-67.03	-95.0	-117.3	-137.6	8.3	-90.51
4.00	107.16	2441.3	2422.8	2407.4	10.25	9.56	8.89	39.36	-28.6	-28.6	-48.8	1.59	4.82	-67.08	-94.9	-117.5	-137.7	10.0	-92.87
5.00	98.05	2544.5	2527.4	2515.2	10.32	9.72	9.19	39.19	-21.0	-25.6	-45.1	1.31	3.43	-67.42	-94.8	-117.1	-137.3	23.1	-101.61
6.00	105.74	2649.4	2630.0	2617.5	10.01	9.49	9.06	39.08	-18.9	-31.1	-50.2	1.52	3.04	-68.22	-92.5	-114.9	-135.2	38.7	-106.50
7.03	103.26	2758.8	2739.6	2726.1	9.92	9.23	8.76	39.09	-20.3	-36.3	-48.0	1.68	3.63	-67.20	-92.9	-115.1	-135.5	63.8	-111.13
8.50	98.23	2909.6	2891.1	2877.6	9.80	9.13	8.54	39.07	-17.1	-34.2	-47.4	1.56	1.81	-68.14	-94.0	-116.3	-137.0	89.6	-113.94
9.00	105.87	2961.4	2940.3	2927.5	9.49	9.20	8.68	39.05	-17.3	-36.7	-49.1	1.70	7.52	-66.04	-92.5	-115.6	-136.2	100.0	-115.14
10.00	104.82	3064.7	3041.0	3027.6	9.16	8.99	8.66	39.03	-17.1	-33.1	-48.7	1.71	6.78	-64.52	-91.8	-115.2	-135.7	150.3	-118.91
11.00	99.57	3163.7	3142.0	3128.3	9.10	8.70	8.31	39.00	-15.6	-37.1	-50.1	1.30	6.18	-63.92	-91.9	-115.3	-136.2	176.4	-119.94
12.00	96.72	3260.8	3239.3	3226.5	8.82	8.37	7.83	39.03	-15.2	-41.7	-47.1	0.80	6.21	-62.80	-90.7	-114.9	-136.0	210.9	-122.03
13.00	82.64	3351.4	3330.5	3317.8	8.56	8.07	7.42	39.06	-15.7	-40.8	-46.5	0.32	7.58	-62.07	-90.2	-115.8	-136.9	296.0	-124.93
14.00	60.52	3430.5	3410.3	3397.3	8.24	7.63	7.14	39.08	-15.2	-44.1	-46.2	0.06	4.07	-61.48	-92.4	-116.8	-137.4	347.5	-126.04
15.00	54.89	3494.5	3471.2	3457.4	7.93	7.60	7.18	39.13	-15.1	-42.3	-49.4	0.38	5.54	-64.34	-91.9	-114.2	-134.7	487.8	-128.87
16.00	38.98	3542.0	3521.3	3508.0	7.87	7.34	6.92	39.13	-15.4	-56.8	-54.7	0.64	7.37	-67.48	-94.8	-116.5	-137.0	583.0	-130.45
17.00	34.95	3582.3	3558.5	3545.5	7.67	7.37	6.89	39.15	-17.1	-39.2	-54.8	1.12	8.28	-65.96	-93.3	-114.7	-135.0	960.8	-134.96
18.00	30.46	3614.4	3591.8	3578.0	7.56	7.19	6.80	39.16	-16.1	-44.2	-55.9	1.31	10.90	-66.66	-93.2	-114.6	-134.9	1000.0	-135.45

\*at 25°C unless mentioned otherwise

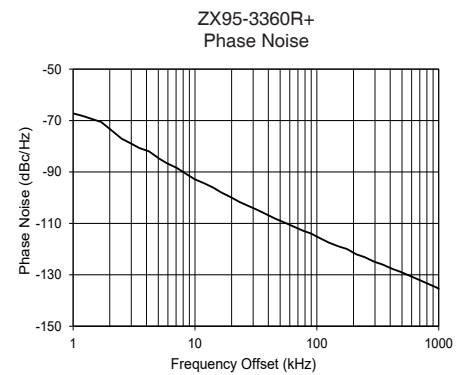
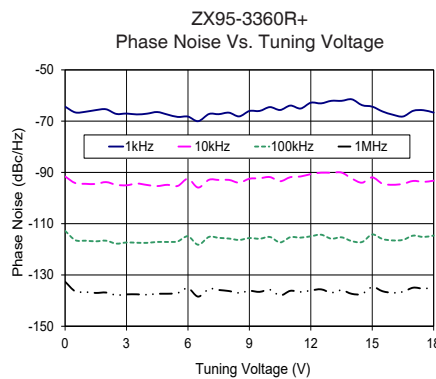
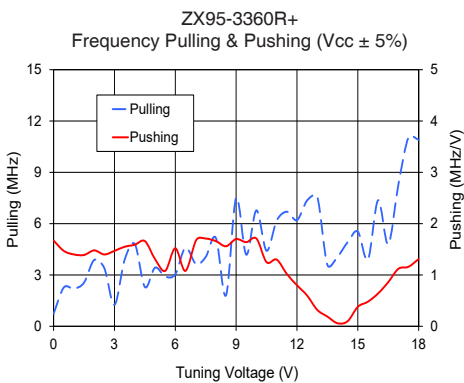
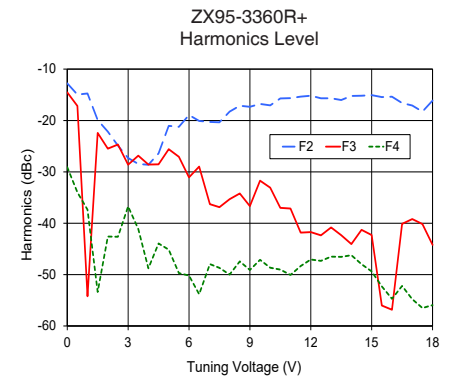
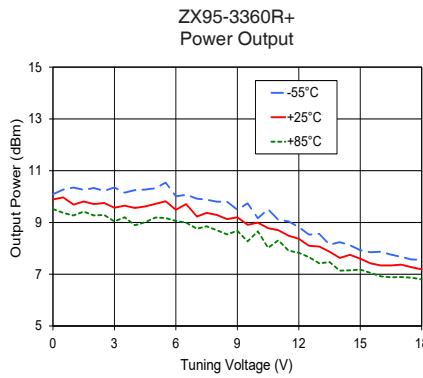
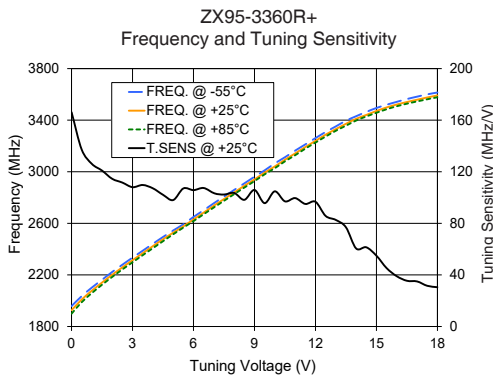

## Additional Notes

- Performance and quality attributes and conditions not expressly stated in this specification document are intended to be excluded and do not form a part of this specification document.
- Electrical specifications and performance data contained in this specification document are based on Mini-Circuit's applicable established test performance criteria and measurement instructions.
- The parts covered by this specification document are subject to Mini-Circuits standard limited warranty and terms and conditions (collectively, "Standard Terms"); Purchasers of this part are entitled to the rights and benefits contained therein. For a full statement of the Standard Terms and the exclusive rights and remedies thereunder, please visit Mini-Circuits' website at [www.minicircuits.com/MCLStore/terms.jsp](http://www.minicircuits.com/MCLStore/terms.jsp)

