



3A Low-Dropout Linear Regulator

Features

- Available in 1.5V, 1.8V, 2.5V, 3.3V version
- TO-220, TO-263 package
- Internal short circuit current limiting
- Internal over temperature protection
- Output current 3A

Applications

- Post regulation for switching DC/DC converter
- High efficiency linear regulator
- Battery powered instrumentation
- Motherboard

General Description

The G1085-XX is a low dropout linear regulator with a dropout of 0.8V at 3A of load current. It is available in three fixed voltages: 1.5V, 1.8V, 2.5V and 3.3V. Refer to the G1085 for the adjustable version.

The G1085-XX provides over temperature and over current protection circuits to prevent it from being damaged by abnormal operating conditions.

The G1085-XX is available in TO-220 and TO-263 packages. A minimum of 220 μ F tantalum electrolytic capacitor is required at the output to improve the transient response and stability.

Ordering Information

ORDER NUMBER	ORDER NUMBER (Pb free)	MARKING	TEMP. RANGE	PACKAGE	PIN OPTION		
					1	2	3
G1085-15T33T	G1085-15T33Tf	G1085-15	-40°C to +85°C	TO-220	GND	V _{OUT}	V _{IN}
G1085-18T33T	G1085-18T33Tf	G1085-18	-40°C to +85°C	TO-220	GND	V _{OUT}	V _{IN}
G1085-25T33T	G1085-25T33Tf	G1085-25	-40°C to +85°C	TO-220	GND	V _{OUT}	V _{IN}
G1085-33T33T	G1085-33T33Tf	G1085-33	-40°C to +85°C	TO-220	GND	V _{OUT}	V _{IN}
G1085-15T53U	G1085-15T53Uf	G1085-15	-40°C to +85°C	TO-263	GND	V _{OUT}	V _{IN}
G1085-18T53U	G1085-18T53Uf	G1085-18	-40°C to +85°C	TO-263	GND	V _{OUT}	V _{IN}
G1085-25T53U	G1085-25T53Uf	G1085-25	-40°C to +85°C	TO-263	GND	V _{OUT}	V _{IN}
G1085-33T53U	G1085-33T53Uf	G1085-33	-40°C to +85°C	TO-263	GND	V _{OUT}	V _{IN}

* For other package types and pin options, please contact us at sales @gmt.com.tw

Order Number Identification

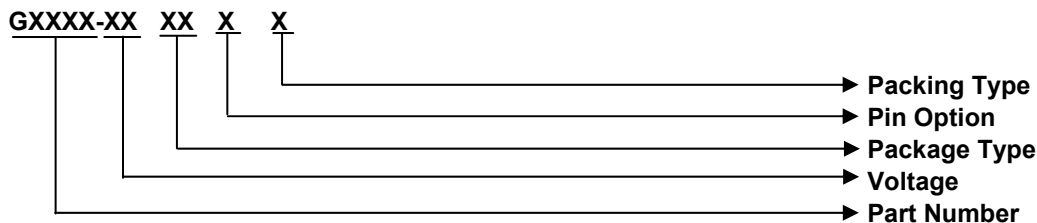

PACKAGE TYPE

T3: TO-220

T5: TO-263

PIN OPTION

1 2 3

3: GND V_{OUT} V_{IN}

PACKING

U: Tape & Reel

T: Tube

Package Type

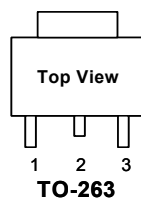
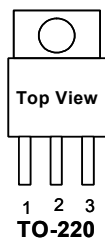

Typical Application

[Note 4]: Type of C_{OUT}

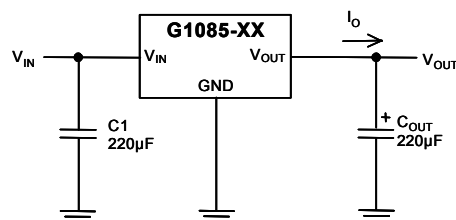



Absolute Maximum Ratings	(Note 1)
Input Voltage.....	8V
Power Dissipation Internally Limited	(Note 2)
Maximum Junction Temperature.....	150°C
Storage Temperature Range.....	-65°C ≤ T _J ≤ +150°C
Reflow Temperature (soldering, 10sec).....	260°C
Thermal Resistance Junction to Ambient	
TO-220 ⁽¹⁾ , TO-263 ⁽¹⁾	92°C/W
Thermal Resistance Junction to Case	
TO-220, TO-263.....	6°C/W
ESD Rating (Human Body Model).....	2kV

Operating Conditions	(Note 1)
Input Voltage.....	2.2V~7V
Temperature Range.....	-40°C ≤ T _A ≤ 85°C

Note ⁽¹⁾: See Recommended Minimum Footprint

Electrical Characteristics

V_{IN} = 5V, C_{IN} = C_{OUT} = 220μF, T_A = T_J = 25°C unless otherwise specified. (Note3)

PARAMETER	CONDITION	MIN	TYP	MAX	UNIT
Output Voltage	10mA ≤ I _{OUT} ≤ 3A	-2%	V _O	2%	V
Line Regulation	(V _{OUT} + 0.7V) ≤ V _{IN} ≤ 5.5V, I _{OUT} = 10mA	---	0.1	1	%
Load Regulation	G1085-18 V _{IN} =3.8V, 10mA ≤ I _{OUT} ≤ 3A	---	1	2	%
	G1085-25 V _{IN} =5V, 10mA ≤ I _{OUT} ≤ 3A				
	G1085-33 V _{IN} =5V, 10mA ≤ I _{OUT} ≤ 3A				
Dropout Voltage	G1085-18 ΔV _{OUT} = 2%, I _{OUT} = 3A	---	1	1.2	V
	G1085-25 ΔV _{OUT} = 2%, I _{OUT} = 3A				
	G1085-33 ΔV _{OUT} = 2%, I _{OUT} = 3A				
Current Limit	(V _{IN} - V _{OUT}) = 2V	---	5.5	---	A
Short Circuit Current		---	1	---	A
Quiescent Current	G1085-18 V _{IN} = 5V	0.5	1.7	5	mA
	G1085-25 V _{IN} = 5V	0.5	2.1	5	
	G1085-33 V _{IN} = 5V	0.5	2.4	5	
Ripple Rejection	f = 120Hz, C _{OUT} = 10μF Tantalum, (V _{IN} - V _{OUT}) = 3V, I _{OUT} = 1A	---	50	---	dB
Thermal Resistor Junction-to-Ambient (No heat sink; No air flow)	TO-220; Recommended Minimum Footprint	---	92	---	°C/W
	TO-263; Recommended Minimum Footprint	---	92	---	
Thermal Resistance Junction-to-Case	TO-220	---	6	---	°C/W
	TO-263	---	6	---	
Thermal Shutdown	Junction Temperature	---	150	---	°C

Note 1: Absolute Maximum Ratings are limits beyond which damage to the device may occur. Operating Conditions are conditions under which the device functions but the specifications might not be guaranteed. For guaranteed specifications and test conditions see the Electrical Characteristics.

Note2: The maximum power dissipation is a function of the maximum junction temperature, T_{Jmax}; total thermal resistance, θ_{JA}, and ambient temperature T_A. The maximum allowable power dissipation at any ambient temperature is T_{Jmax}-T_A / θ_{JA}. If this dissipation is exceeded, the die temperature will rise above 150°C and IC will go into thermal shutdown.

Note3: Low duty pulse techniques are used during test to maintain junction temperature as close to ambient as possible.

Note4: The type of output capacitor should be tantalum or aluminum.

Definitions

Dropout Voltage

The input/output Voltage differential at which the regulator output no longer maintains regulation against further reductions in input voltage. Measured when the output drops 2% below its nominal value. Dropout voltage is affected by junction temperature, load current and minimum input supply requirements.

Line Regulation

The change in output voltage for a change in input voltage. The measurement is made under conditions of low dissipation or by using pulse techniques such that average chip temperature is not significantly affected.

Load Regulation

The change in output voltage for a change in load current at constant chip temperature. The measurement is made under conditions of low dissipation or by using pulse techniques such that average chip temperature is not significantly affected.

Maximum Power Dissipation

The maximum total device dissipation for which the regulator will operate within specifications.

Quiescent Bias Current

Current which is used to operate the regulator chip and is not delivered to the load.



Electrical Characteristics

$V_{IN}-V_{OUT} = 3V$, $C_{IN} = 220\mu F$, $C_{OUT} = 220\mu F$, $T_A=25^\circ C$, unless otherwise noted.

Line Transient Response

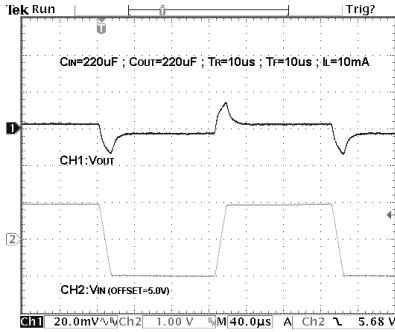

Load Transient Response

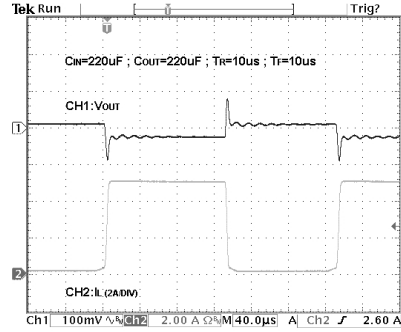

Short Circuit Current

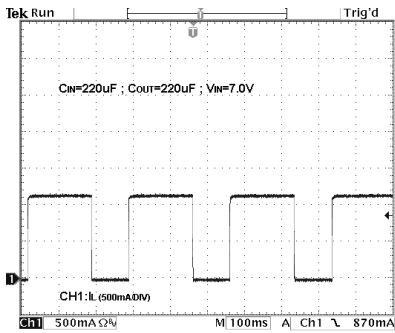

Ripple Rejection

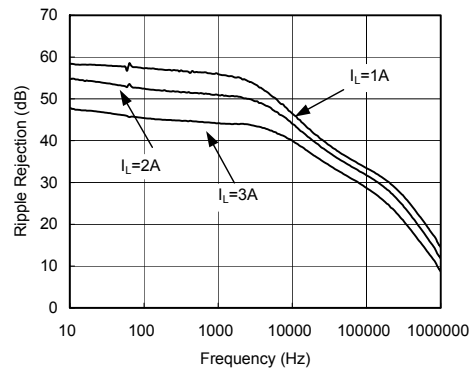

G1085-33 Overcurrent Protection Characteristics

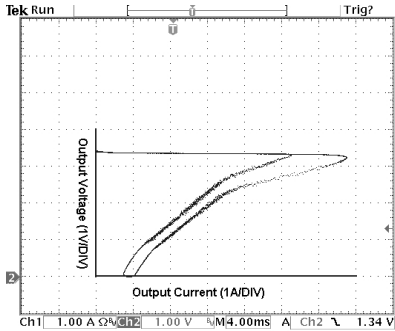

G1085-33 Start-up

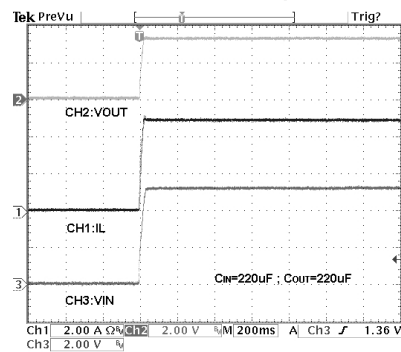



Typical Performance Characteristics (continued)

G1085-18 Overcurrent Protection Characteristics

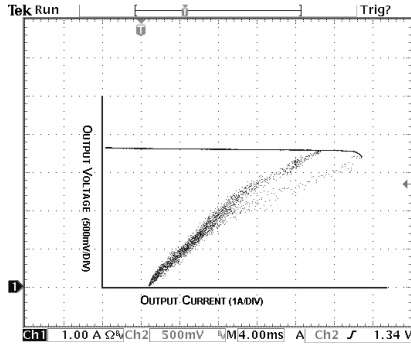

G1085-18-Start-up

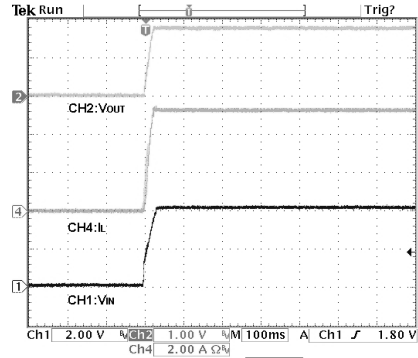

G1085 Max. Power Dissipation vs. PCB Top Copper Area

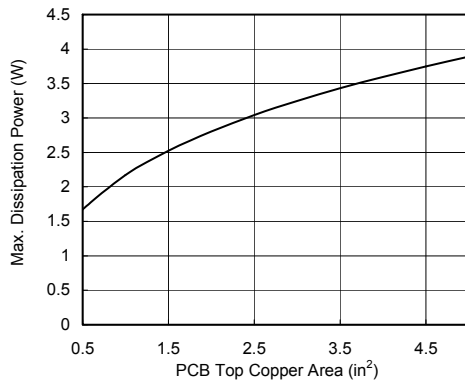

G1085 Max. Power Dissipation vs. T_{AMB}

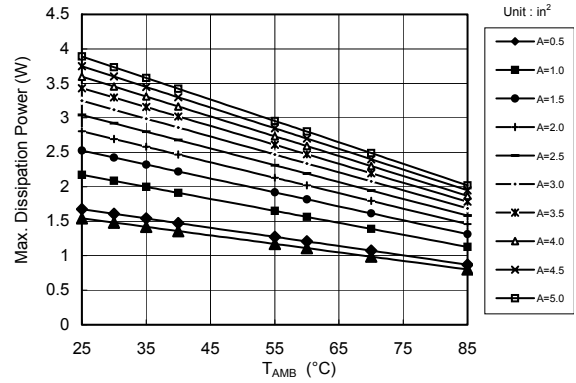

G1085-18 Quiescent Current vs. Temperature

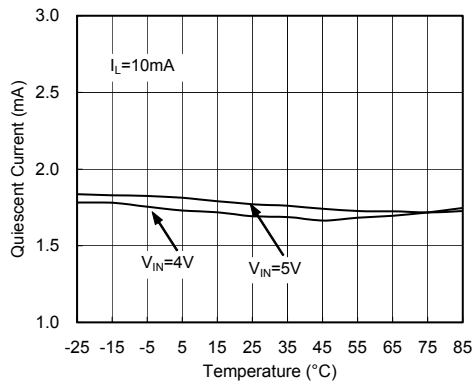

G1085-18 Dropout Voltage vs. I_L

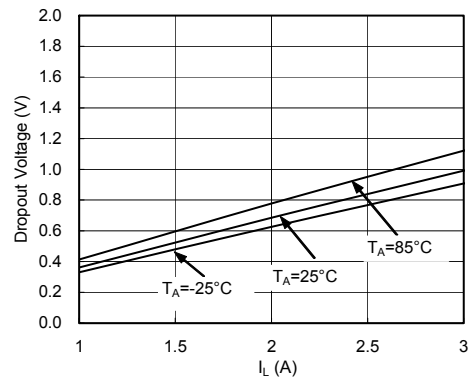



Typical Performance Characteristics (continued)

G1085-18 Output Voltage vs. Temperature

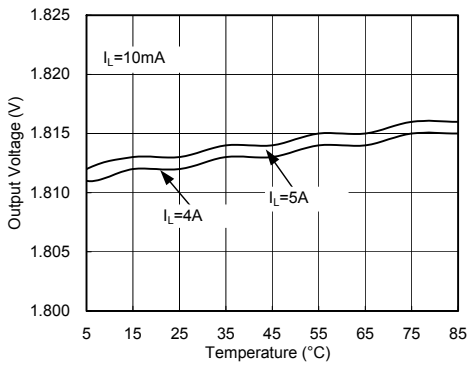

G1085-18 Output Voltage vs. I_L

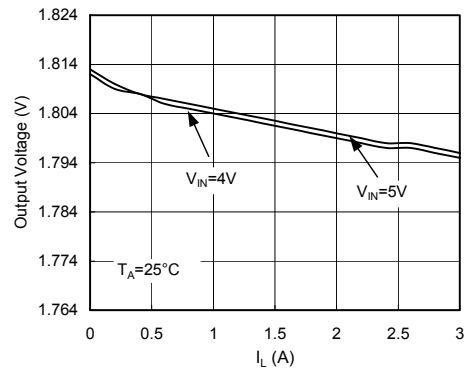

G1085-33 Quiescent Current vs. Temperature

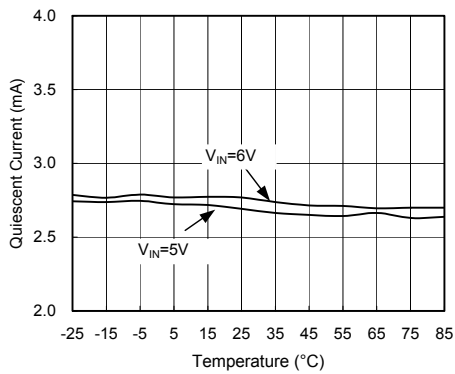

G1085-33 Dropout Voltage vs. I_L

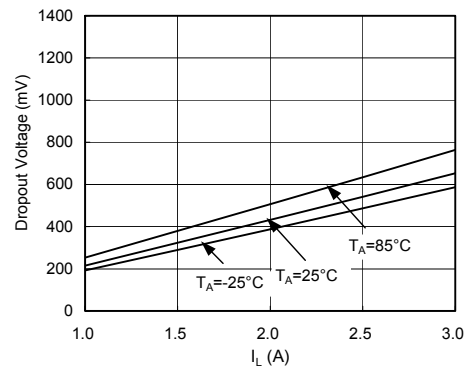

G1085-33-Output Voltage vs. Temperature

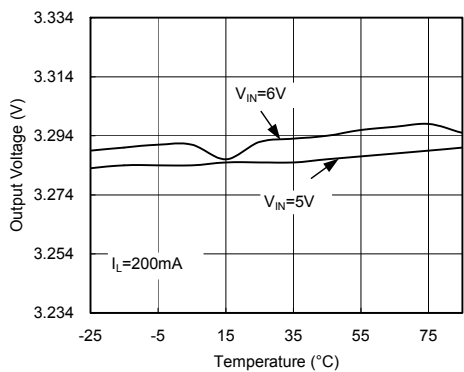

G1085-33 Output Voltage vs. I_L

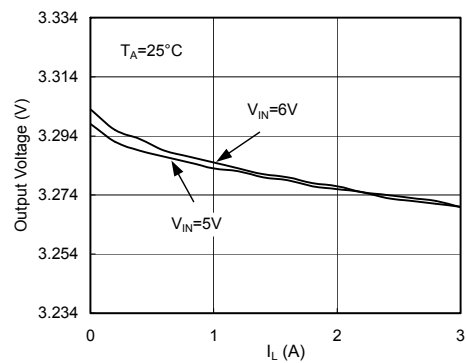

Typical Performance Characteristics (continued)

G1085-25 Quiescent Current vs. Temperature

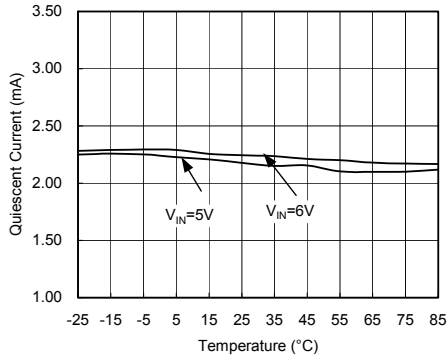

G1085-25 Dropout Voltage vs. I_L

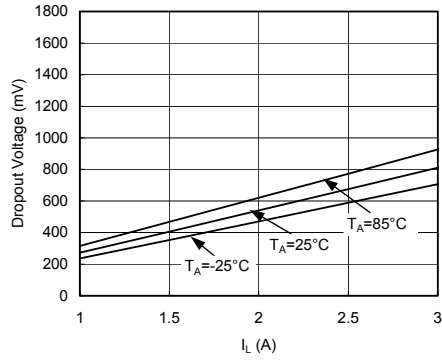

G1085-25 Output Voltage vs. Temperature

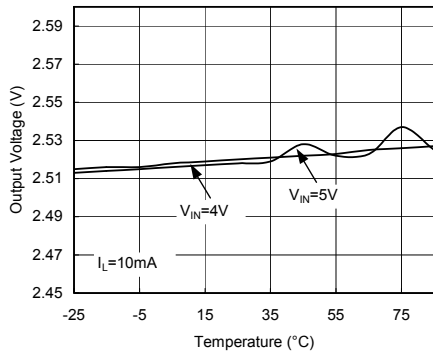

G1085-25 Output Voltage vs. I_L

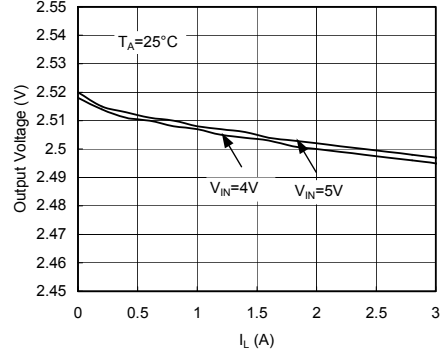

Recommend Minimum Footprint

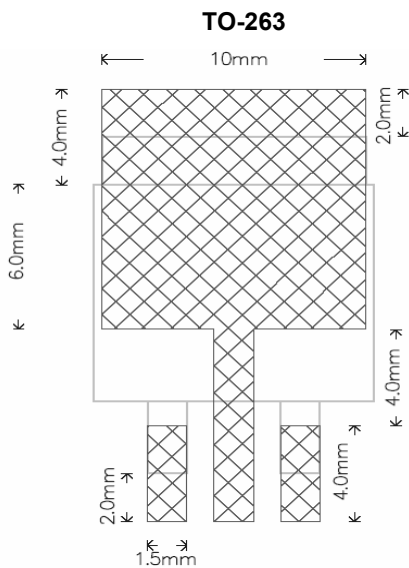

Package Information

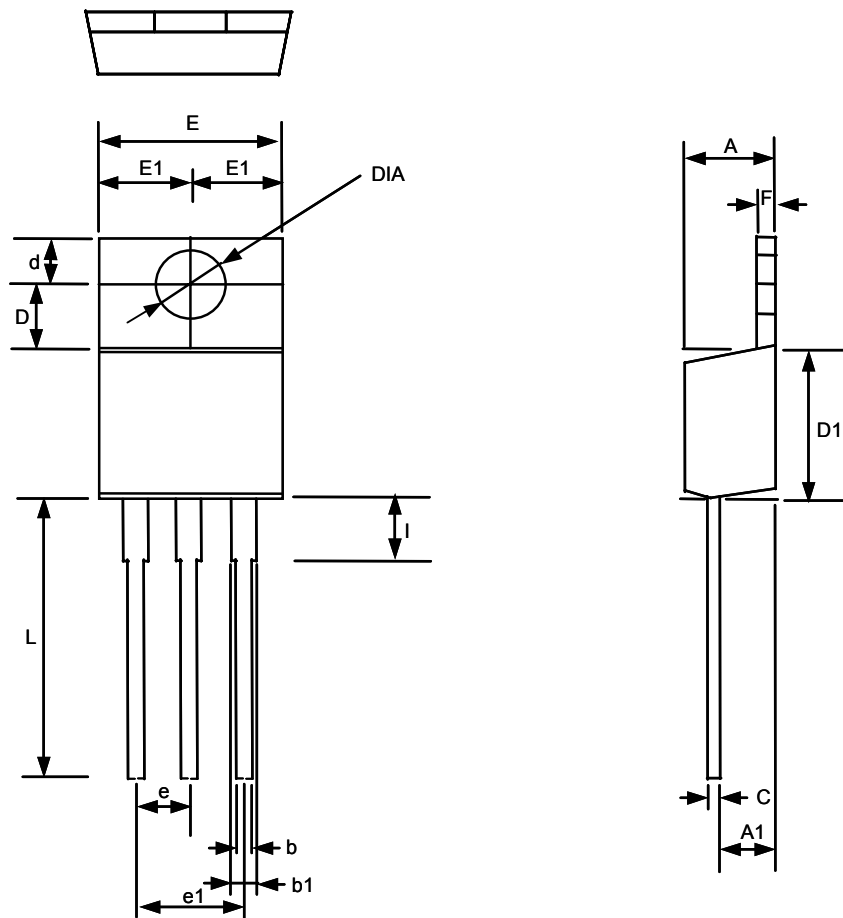

TO-220 (T3) Package

SYMBOL	MILLIMETER		INCH	
	MIN	MAX	MIN	MAX
A	4.318	4.826	0.170	0.190
A1	2.46	2.72	0.097	0.107
b	0.69	0.94	0.027	0.037
b1	1.143	1.397	0.045	0.055
C	0.304	0.460	0.012	0.018
D	3.429	3.683	0.135	0.145
D1	8.53	9.04	0.336	0.356
d	2.62	2.87	0.103	0.113
E	9.906	10.40	0.390	0.410
E1	4.953	5.22	0.195	0.206
DIA	3.708	3.962	0.146	0.156
e	2.29	2.79	0.090	0.110
e1	4.83	5.33	0.190	0.210
F	1.143	1.397	0.045	0.055
L	13.589	14.351	0.535	0.565
I	3.56	4.06	0.140	0.16

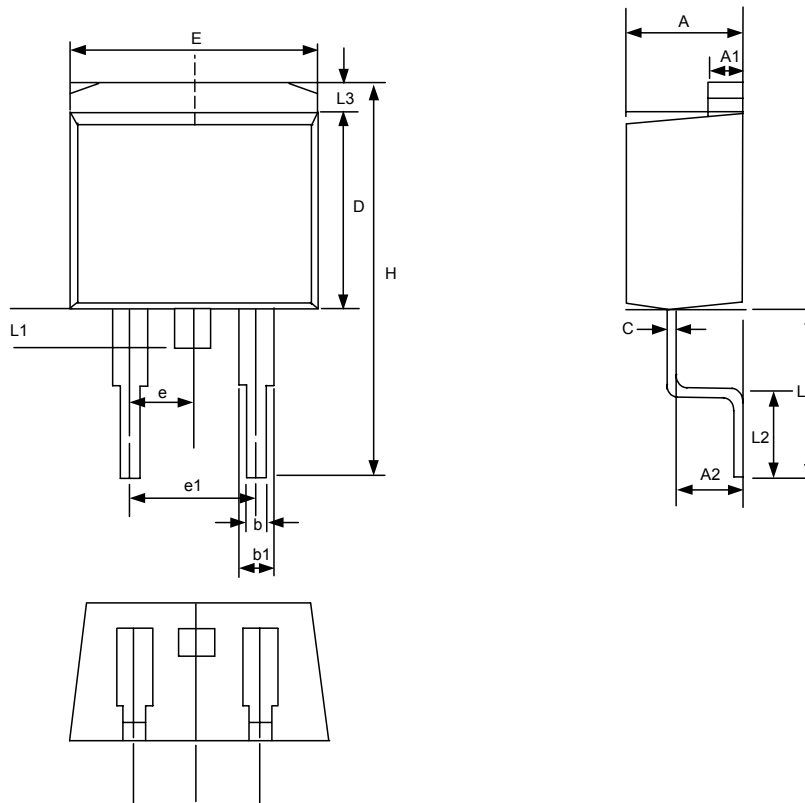

TO-263 (T5) Package

SYMBOL	MILLIMETER		INCH	
	MIN	MAX	MIN	MAX
A	4.30	4.70	0.169	0.185
A1	1.22	1.32	0.048	0.055
A2	2.45	2.69	0.104	0.106
b	0.69	0.94	0.027	0.037
b1	1.22	1.40	0.048	0.055
C	0.36	0.56	0.014	0.022
D	8.64	9.652	0.340	0.380
E	9.70	10.54	0.382	0.415
e	2.29	2.79	0.090	0.110
e1	4.83	5.33	0.190	0.210
H	14.60	15.78	0.575	0.625
L	4.70	5.84	0.185	0.230
L1	1.20	1.778	0.047	0.070
L2	2.24	2.84	0.088	0.111
L3	1.40MAX		0.055MAX	

Taping Specification

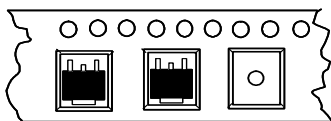

**Feed Direction
TO-263 Package Orientation**

PACKAGE	Q'TY/REEL	Q'TY/TUBE
TO-220	----	50 ea
TO-263	1,000 ea	----

GMT Inc. does not assume any responsibility for use of any circuitry described, no circuit patent licenses are implied and GMT Inc. reserves the right at any time without notice to change said circuitry and specifications.