

SPECIFICATION

Part Number: **RG.02.02.3000W**

Product Name: Road Marker Kit - Quad Band Cellular Antenna RG.01 with CAB.820 Cable Assembly

AMPS/GSM/PCS/DCS

850/900/1800/1900

Features: Low Profile - Diameter 101.4 mm*Height 17.6 mm

UV and Vandal resistant PP housing

RG.01: 1.5M WY-100 cable SMB(M) Jack

CAB.820: 1.5M WY-100 SMB(F) to TNC(M)ST

RoHS Compliant

Top



Bottom



1. Introduction

Taoglas USA has designed a range of efficient antennas inside US standard raised non-reflective road markers. These are designed for, and installed inside, the low profile "Bott's dots" that can be mounted directly on the pavement and road in the USA.

These antennas exhibit remarkably high efficiencies in such small packages and live in a very low profile enclosure. They are designed to be mounted directly on the road, pavement, or manhole cover, just like a standard road marker.

These antennas have been potted with the epoxy that is traditionally used to secure the road marker itself to the ground. There are no air gaps whatsoever inside the new type approved road marker with antenna, in order to maintain the mechanical integrity. It is presumed that the standard black epoxy will also be used to install the road marker in its final resting place on the ground.

The CAB.820 cable assembly is included so the antenna cable can be easily disconnected if desired. This is useful when the antenna is mounted on a manhole cover. If the manhole cover is lifted, the cable will split at the push-pull connectors, preventing damage to the cable.

2. Specification

ELECTRICAL				
Band	AMPS	GSM	DCS	PCS
Frequency (MHz)	824-894	880-960	1710-1880	1850-1990
Polarization	Linear			
Impedance (Ohms)	50 Ohms			
Peak Gain (dBi)	2.5	2.5	1	0.6
Efficiency (%)	30	28	18	18
Return Loss (dB)	-18	-18	-18	-16
Radiation Properties	Omni-directional			
Max Input Power (Watts)	10			
MECHANICAL				
Dimensions	Height = 17.6 mm and Diameter = 101.4 mm			
Cable	WY-100 Coaxial Cable			
Connector	Fully Customizable			
Casing	UV Resistant PP			
Sealant	Potting			
ENVIRONMENTAL				
Protection	IP67			
Corrosion	5% NaCl for 96hrs			
Temperature Range	-40°C to +85°C			
Thermal Shock	100 cycles -40°C to +85°C			
Humidity	Non-condensing 65°C 95% RH			
Shock (Drop Test)	1m drop on concrete 6 axes			
Cable Pull	8 Kgf			

3. Test Set Up

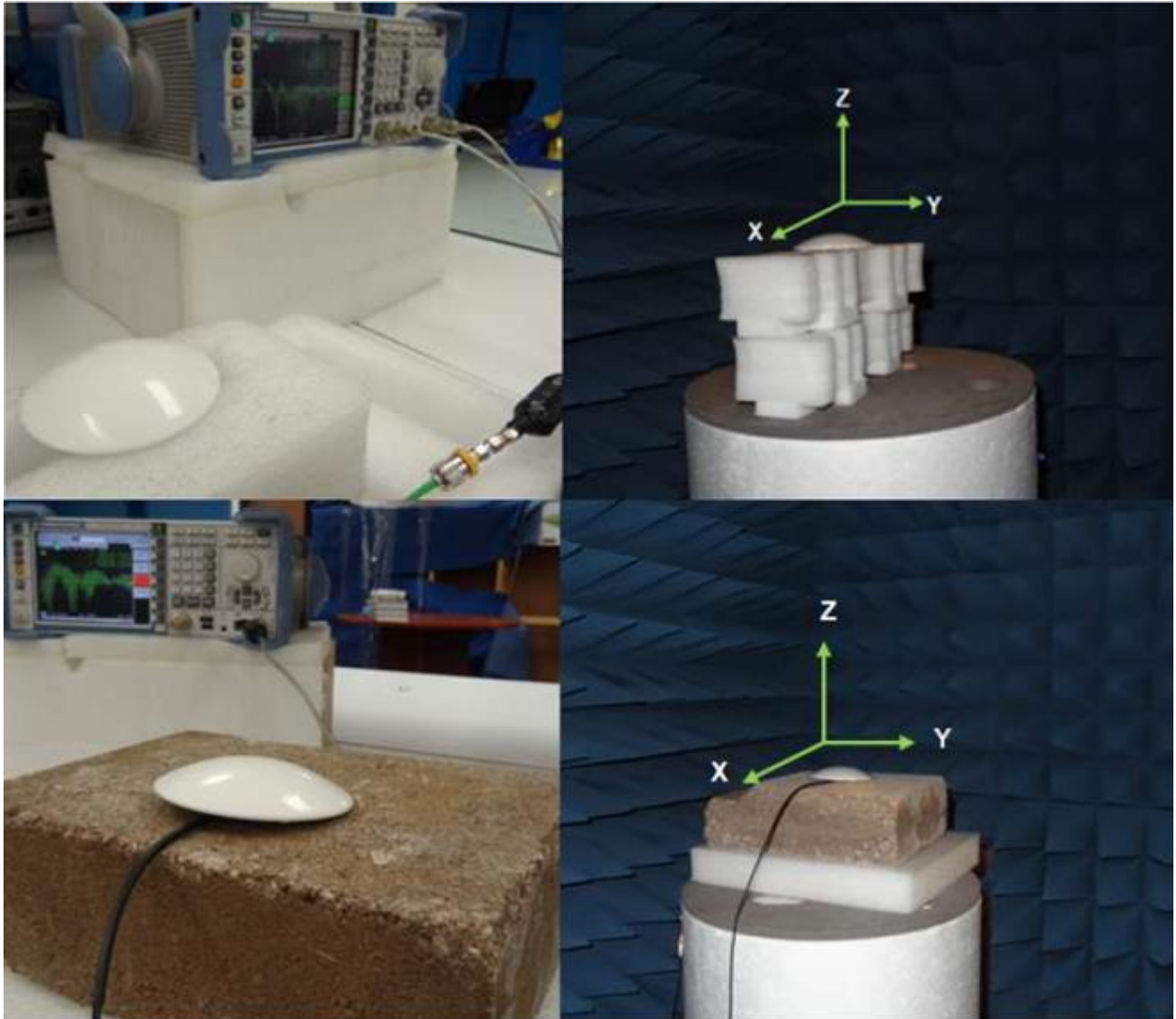

Figure 1. Impedance (left hand), peak gain, efficiency, and radiation pattern measurements (right hand).

* The Cellular Road Marker antenna performance was measured on a piece of concrete, 90 mm thickness.

4. Antenna Parameters

4.1. Return Loss

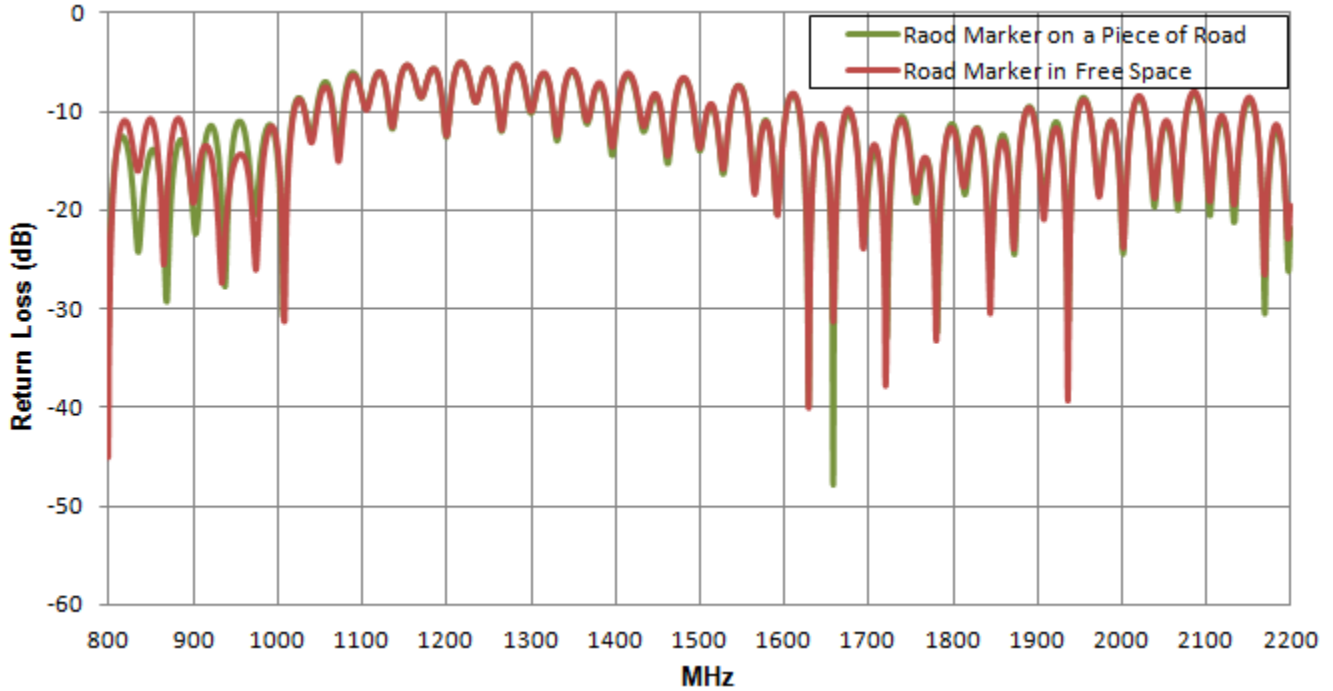

Figure 2. Return Loss Road Marker in Free Space and on a Piece of Road (Concrete).

4.2. Efficiency

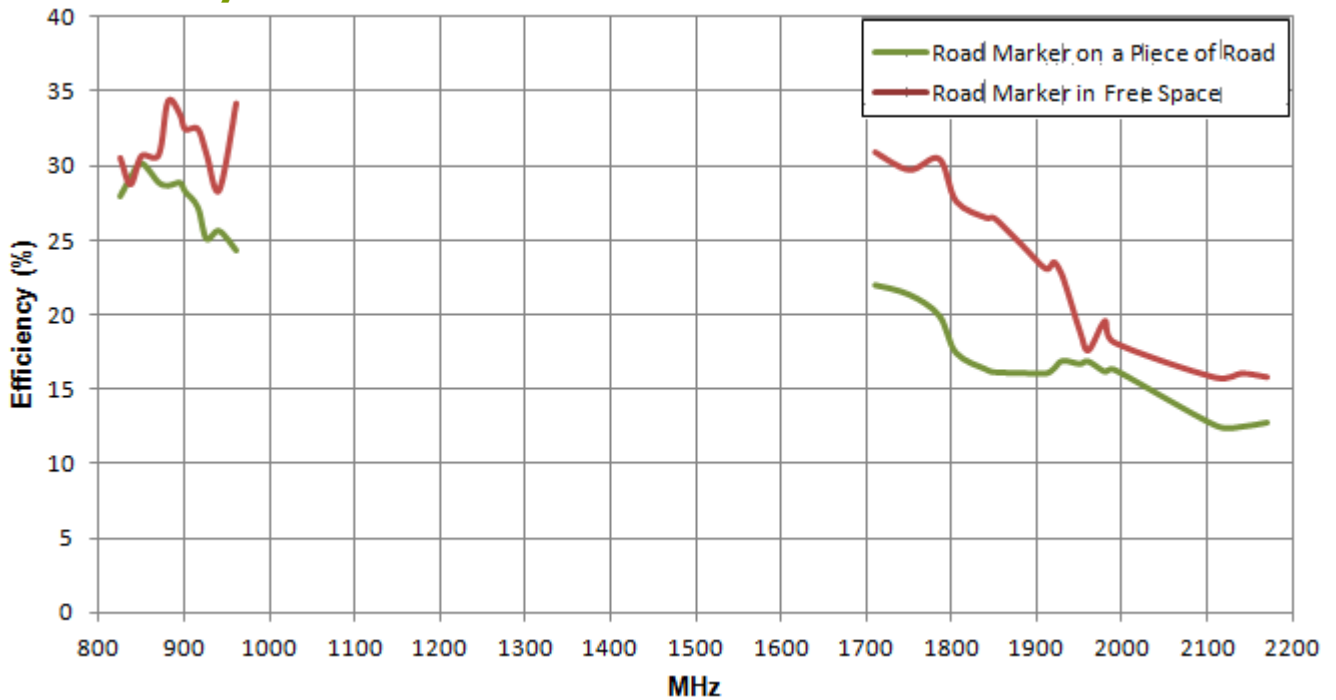

Figure 3. Efficiency Road Marker in Free Space and on a Piece of Road (Concrete).

4.3. Peak Gain

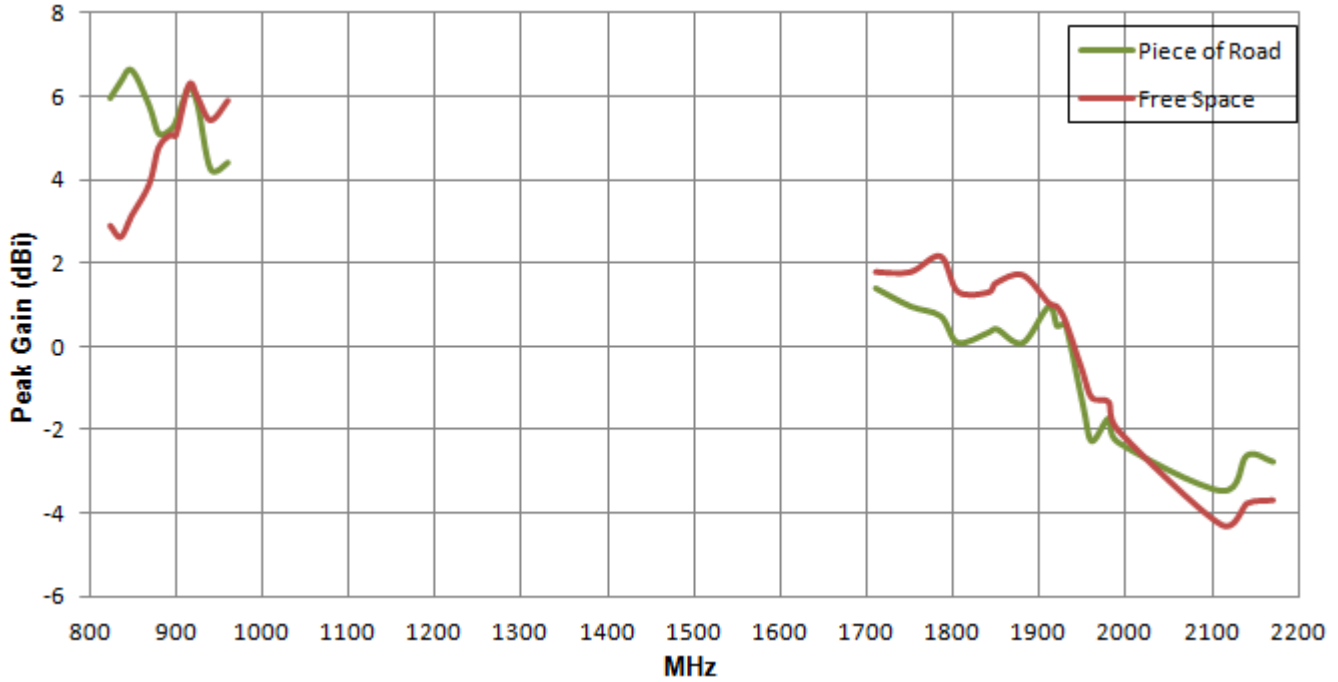

Figure 4. Peak Gain Road Marker in Free Space and on a Piece of Road (Concrete).

4.4. Radiation Pattern

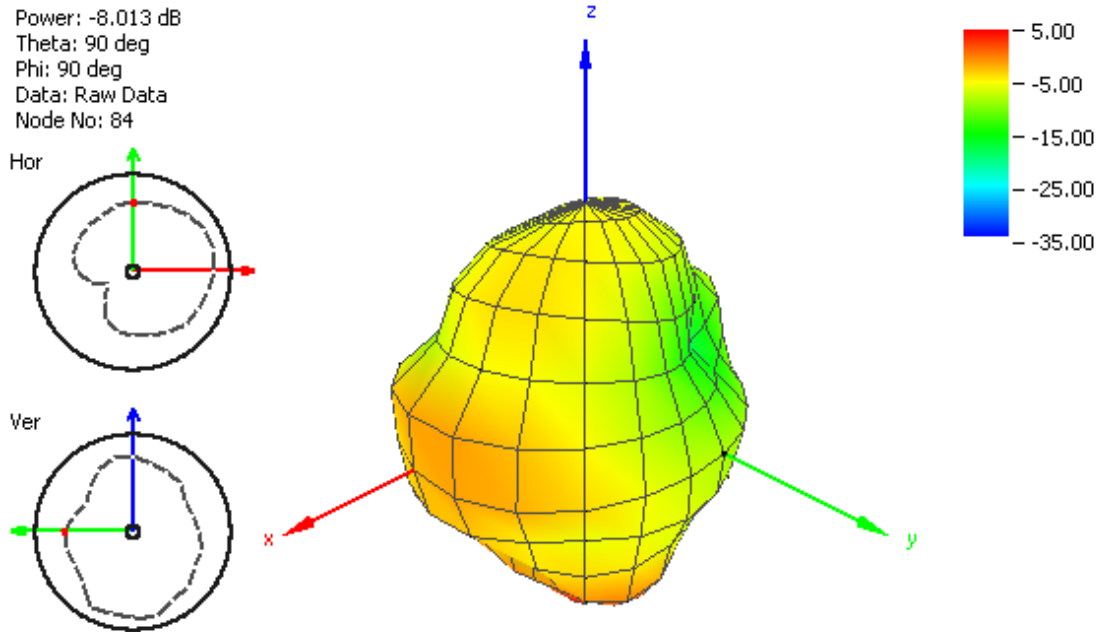

Figure 5. Cellular Road Marker radiation pattern at 849 MHz on Piece of Road (Concrete).

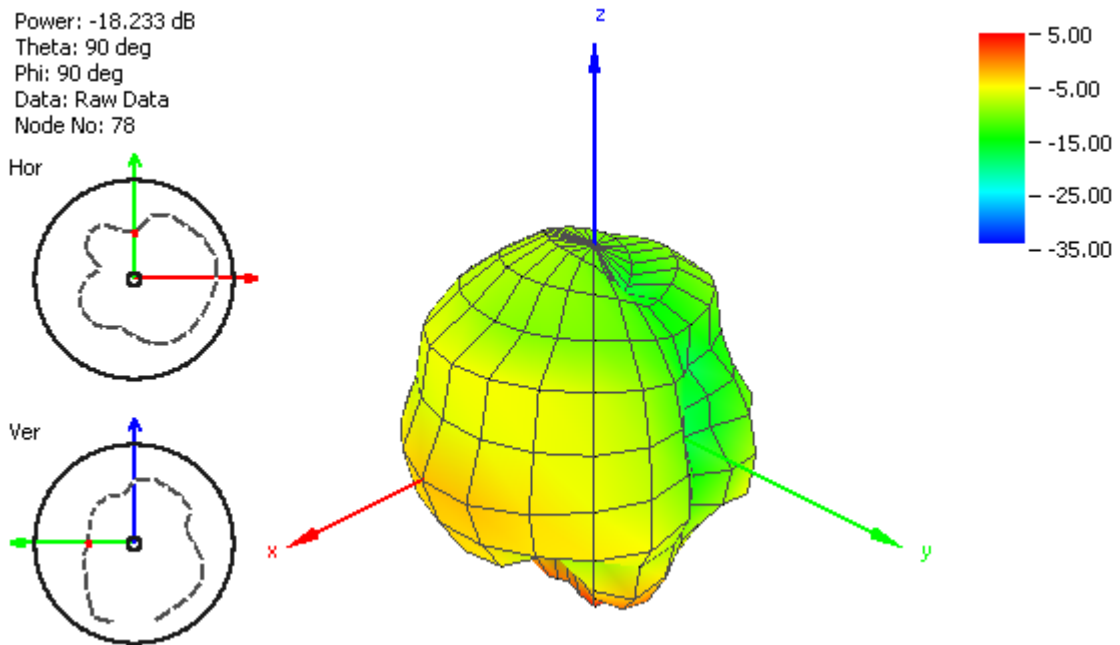

Figure 6. Cellular Road Marker radiation pattern at 940 MHz on Piece of Road (Concrete).

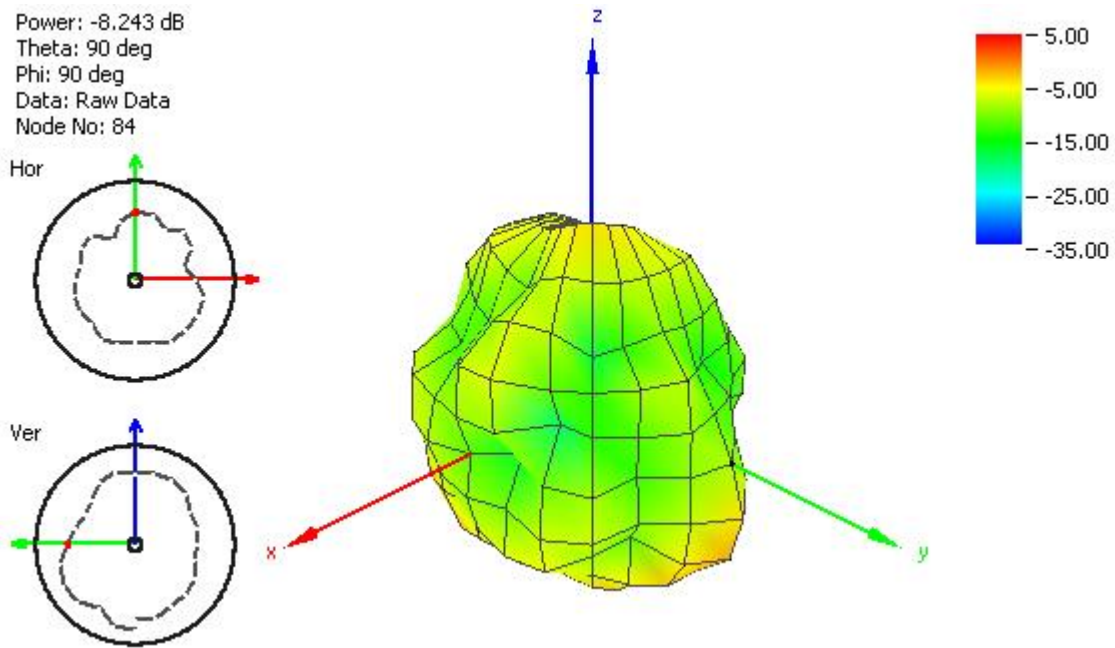

Figure 7. Cellular Road Marker radiation pattern at 1840 MHz on Piece of Road (Concrete).

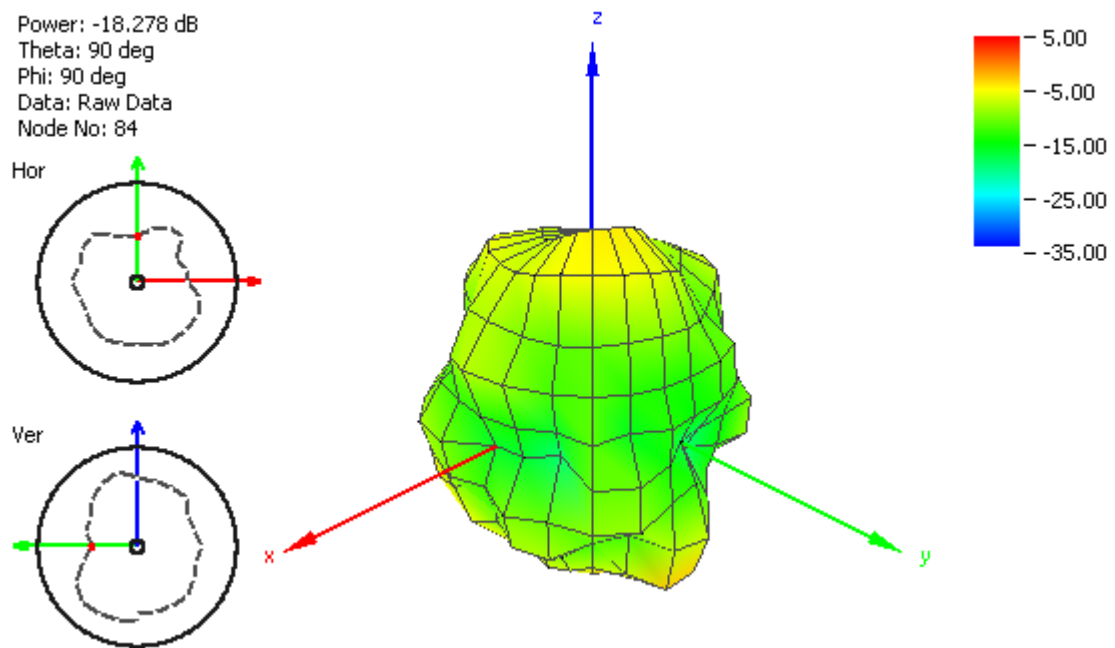

Figure 8. Cellular Road Marker radiation pattern at 1950 MHz on Piece of Road (Concrete).

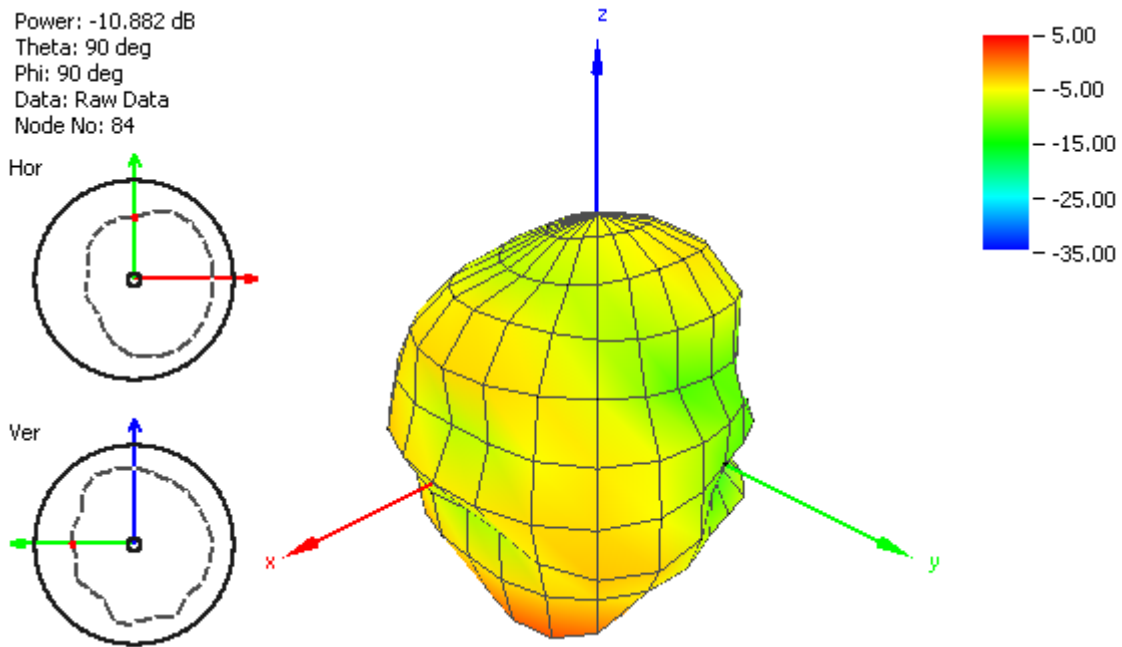

Figure 9. Cellular Road Marker radiation pattern at 849 MHz in Free Space.

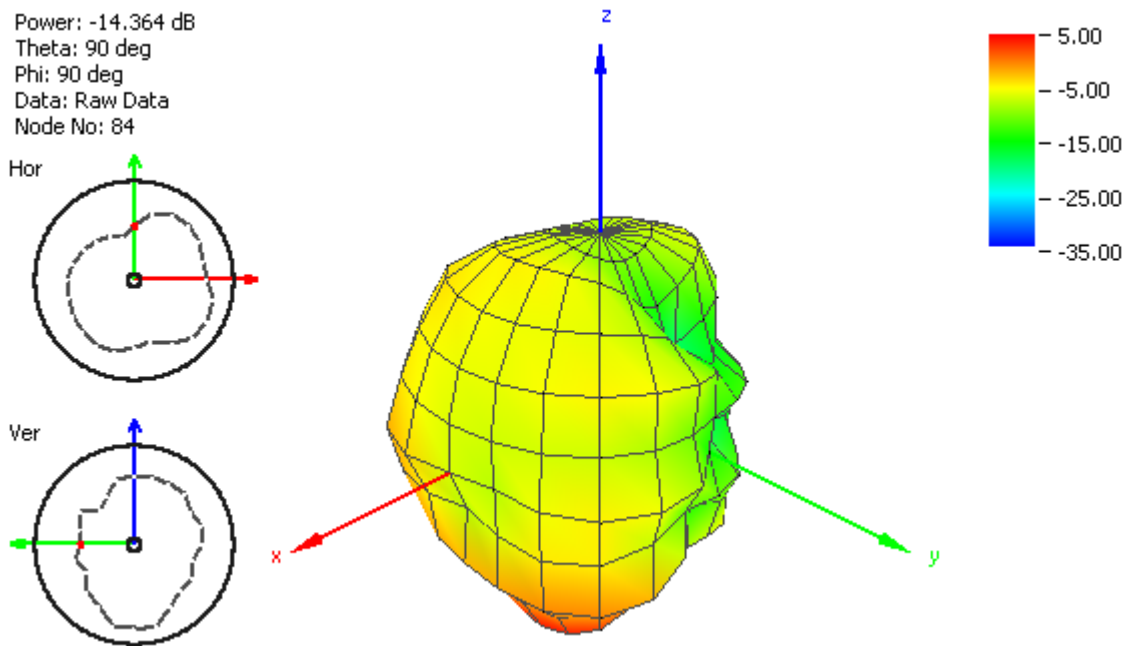

Figure 10. Cellular Road Marker radiation pattern at 940 MHz in Free Space.

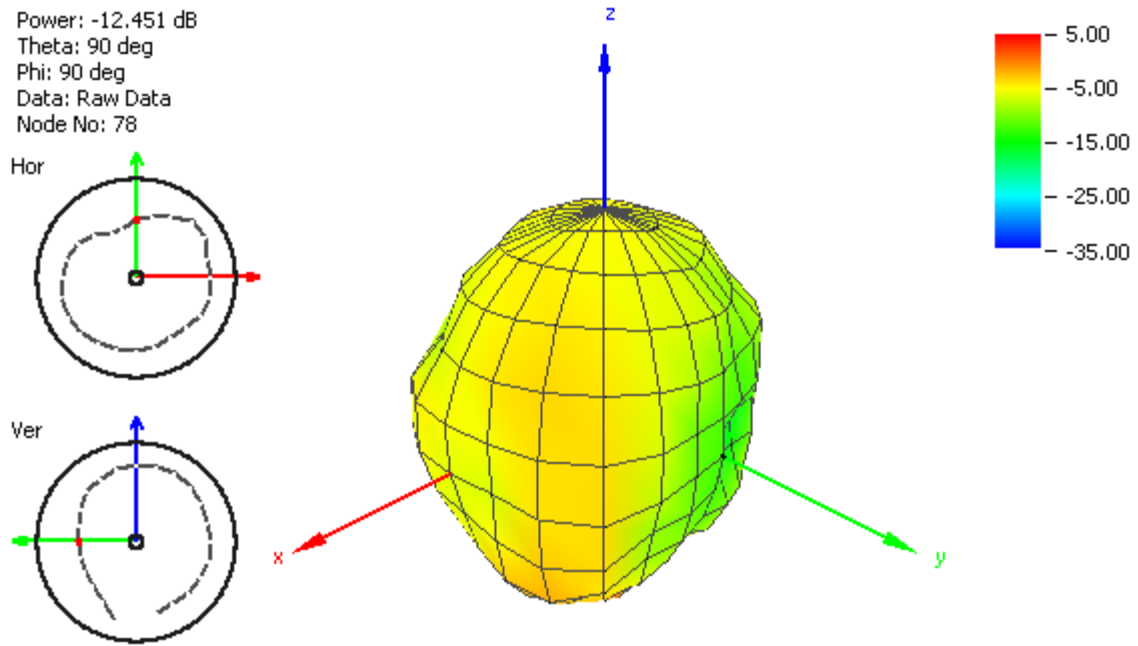

Figure 11. Cellular Road Marker radiation pattern at 1840 MHz in Free Space.

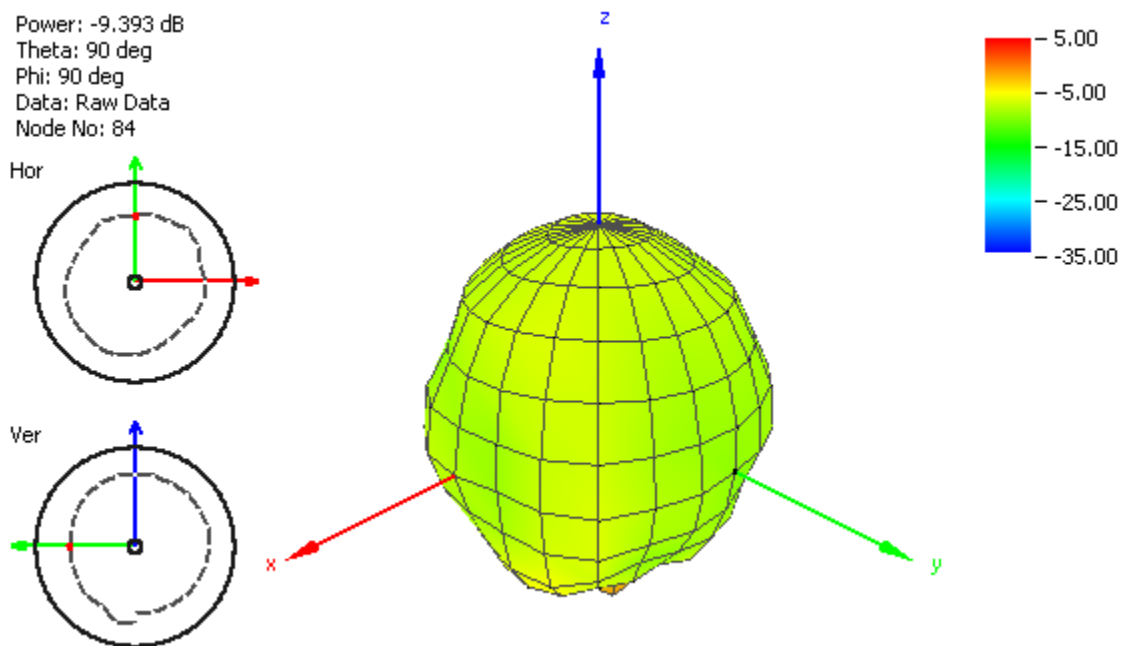
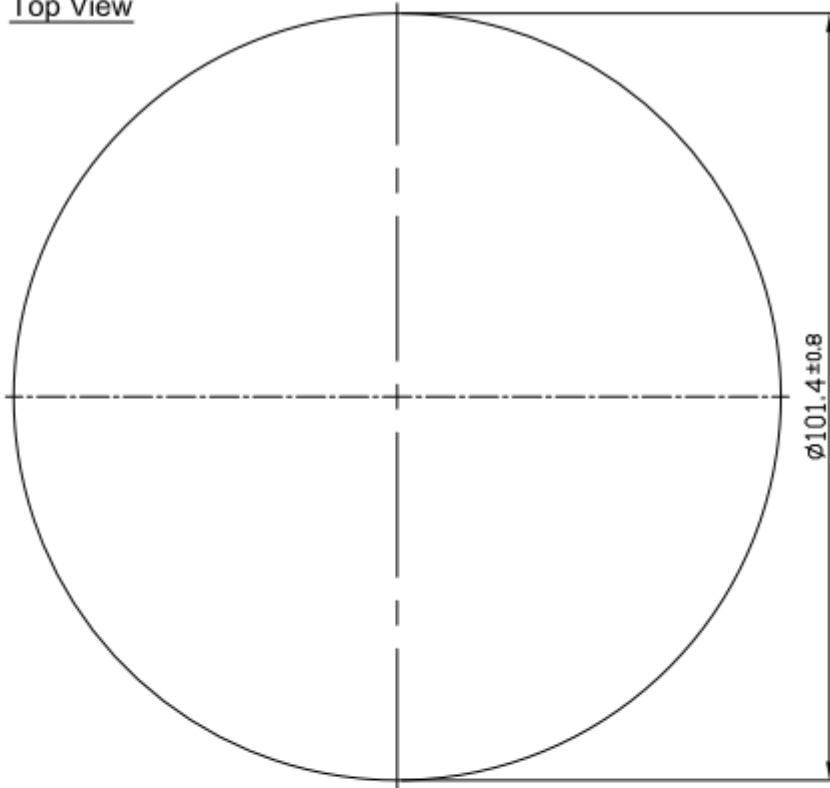

Figure 12. Cellular Road Marker radiation pattern at 1940 MHz in Free Space.

5. MECHANICAL DRAWING

5.1 RG.01 Antenna

Top View



Front View

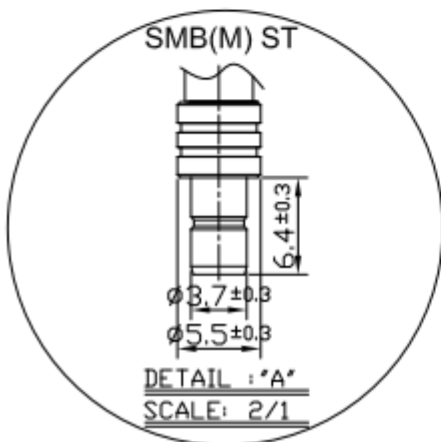
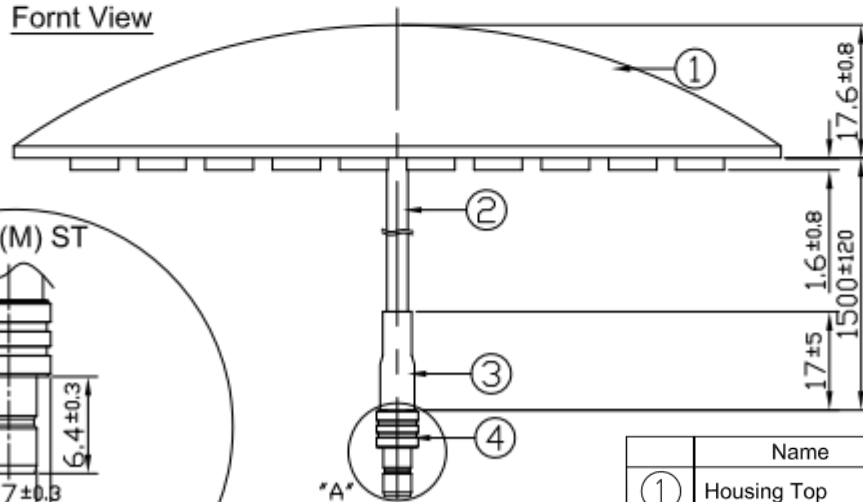

	Name	Material	Finish	QTY
①	Housing Top	PP	White	1
②	WY100 Coaxial Cable	PVC	Black	1
③	Heat Shrink Tube	PE	Black	1
④	SMB(M) ST	Brass	Gold	1

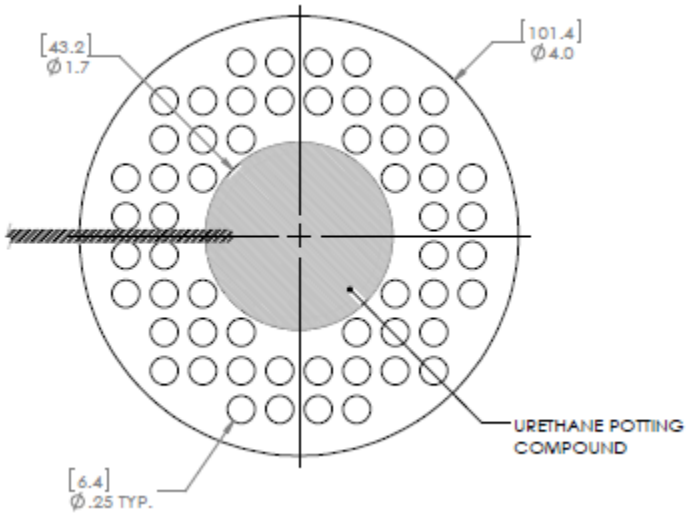

Note: Configuration of bumps or protrusions subject to change without notice

Unit: mm (unless stated otherwise)

5.2 CAB.820 Cable Assembly

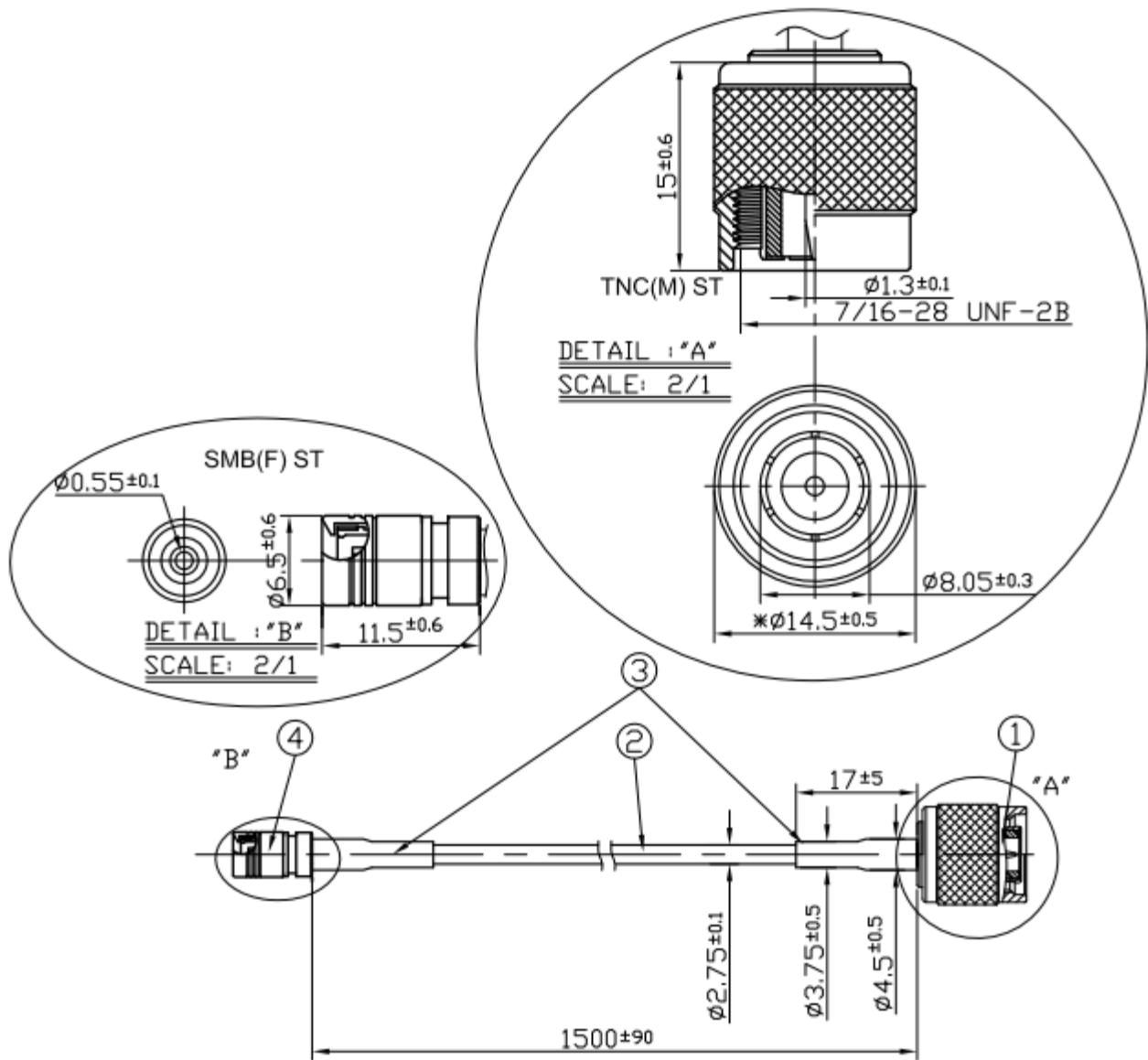

	Name	Material	Finish
1	TNC(M)ST	Brass	Ni Plated
2	WY-100 Coaxial Cable	PVC	Black
3	Heat Shrink Tube	PE	Black
4	SMB(F) Plug ST	Brass	Gold