

Features:

- High speed 10Mbit/s
- Guaranteed performance from -40 to 85°C
- Logic gate output
- High isolation voltage between input and output (Viso=3750 V rms)
- Pb free and RoHS compliant.
- UL approved (No. 214129)
- VDE approved (No. 132249)
- SEMKO approved
- NEMKO approved
- DEMKO approved
- FIMKO approved
- CSA approved (No. 2037145)

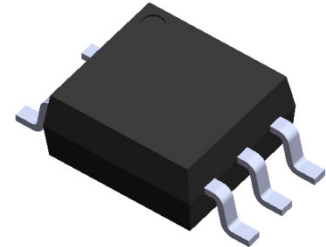

Schematic

Description

The ELM600, ELM601 and ELM611 are consists of an infrared emitting diode optically coupled to a high speed integrated photo detector logic gate with a strobable output.

The devices are packaged in a 5-pin small outline package which conforms to the standard footprint.

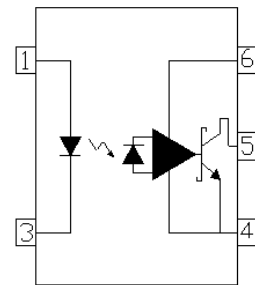

Applications

- Ground loop elimination
- LSTTL to TTL, LSTTL or 5 volt CMOS
- Line receiver, data transmission
- Data multiplexing
- Switching power supplies
- Pulse transformer replacement
- Computer peripheral interface

Pin Configuration

- 1, Anode
- 3, Cathode
- 4, Gnd
- 5, Vout
- 6, VCC

Truth Table

Input	Output
H	L
L	H

Absolute Maximum Ratings ($T_a=25^\circ\text{C}$)

Parameter		Symbol	Rating	Unit
Input	Forward current	I_F	50	mA
	Reverse voltage	V_R	5	V
	Power dissipation	P_D	100	mW
Output	Power dissipation	P_C	85	mW
	Output current	I_O	50	mA
	Output voltage	V_O	7.0	V
	Supply voltage	V_{CC}	7.0	V
Output Power Dissipation		P_O	85	mW
Isolation voltage ^{*1}		V_{ISO}	3750	V rms
Operating temperature		T_{OPR}	-40 ~ +85	°C
Storage temperature		T_{STG}	-55 ~ +125	°C
Soldering temperature ^{*2}		T_{SOL}	260	°C

Notes

*1 AC for 1 minute, R.H.= 40 ~ 60% R.H. In this test, pins 1 & 3 are shorted together, and pins 4 , 5 & 6 are shorted together.

*2 For 10 seconds.

Electrical Characteristics ($T_a=-40$ to 85°C unless specified otherwise)

Input

Parameter	Symbol	Min.	Typ.*	Max.	Unit	Condition
Forward voltage	V_F	-	1.45	1.8	V	$I_F = 10\text{mA}$
Reverse voltage	V_R	5.0	-	-	V	$I_R = 10\mu\text{A}$, $T_A=25^{\circ}\text{C}$
Temperature coefficient of forward voltage	$\Delta V_F/\Delta T_A$	-	-1.9	-	mV/ $^{\circ}\text{C}$	$I_F=10\text{mA}$
Input capacitance	C_{IN}	-	70	-	pF	$V_F=0$, $f=1\text{MHz}$

Output

Parameter	Symbol	Min.	Typ.*	Max.	Unit	Condition
High level supply current	I_{CCH}	-	6.0	9	mA	$I_F=0\text{mA}$, $V_{CC}=5.5\text{V}$
Low level supply current	I_{CCL}	-	7.5	10	mA	$I_F=10\text{mA}$, $V_{CC}=5.5\text{V}$

Transfer Characteristics

Parameter	Symbol	Min.	Typ.*	Max.	Unit	Condition
HIGH Level Output Current	I_{OH}	-	2.1	30	μA	$V_{CC}=5.5\text{V}$, $V_O=5.5\text{V}$, $I_F=250\mu\text{A}$
LOW Level Output Current	V_{OL}	-	0.4	0.6	V	$V_{CC} = 5.5\text{V}$, $I_F=5\text{mA}$, $I_{CL}(\text{Sinking})=13\text{mA}$
Input Threshold Current	I_{FT}	-	2.4	5	mA	$V_{CC}= 5.5\text{V}$, $V_O=0.6\text{V}$, $I_{OL}(\text{Sinking})=13\text{mA}$

Switching Characteristics (T_a=-40 to 85 °C, V_{CC}=5V, I_F=7.5mA unless specified otherwise)

Parameter		Symbol	Min.	Typ.*	Max.	Unit	Condition
Propagation delay time to output High level* ³ (Fig.12)		T _{PHL}	-	41	100	ns	C _L = 15pF, R _L =350Ω, TA=25 °C
Propagation delay time to output Low level* ³ (Fig.12)		T _{PLH}	-	50	100	ns	C _L = 15pF, R _L =350Ω, TA=25 °C
Pulse width distortion		T _{pHl} – T _{plh}	-	9	35	ns	C _L = 15pF, R _L =350Ω
Propagation Delay Skew* ⁴		t _{PSK}	-	-	40	ns	C _L = 15pF, R _L =350Ω
Output rise time (Fig.12)		t _r	-	40	-	ns	C _L = 15pF, R _L =350Ω
Output fall time (Fig.12)		t _f	-	10	-	ns	C _L = 15pF, R _L =350Ω
Common Mode Transient Immunity at Logic High * ⁶ (Fig.14)	M600	CM _H	-	-	-	V/μS	I _F = 7.5mA , V _{OH} =2.0V, R _L =350Ω, TA=25 °C V _{CM} =10Vp-p
	M601		5,000				I _F = 7.5mA , V _{OH} =2.0V, R _L =350Ω, TA=25 °C V _{CM} =50Vp-p
	M611		20,000				I _F = 7.5mA , V _{OH} =2.0V, R _L =350Ω, TA=25 °C V _{CM} =1000Vp-p
Common Mode Transient Immunity at Logic Low * ⁷ (Fig.14)	M600	CM _L	-	-	-	V/μS	I _F = 0mA , V _{OL} =0.8V, R _L =350Ω, TA=25 °C V _{CM} =10Vp-p
	M601		5,000				I _F = 0mA , V _{OL} =0.8V, R _L =350Ω, TA=25 °C V _{CM} =50Vp-p
	M611		20,000				I _F = 0mA , V _{OL} =0.8V, R _L =350Ω, TA=25 °C V _{CM} =1000Vp-p

*All typicals at T_a = 25 °C, V_{CC} = 5 V.

Typical Performance Curves

Figure 1. Forward Current vs Forward Voltage

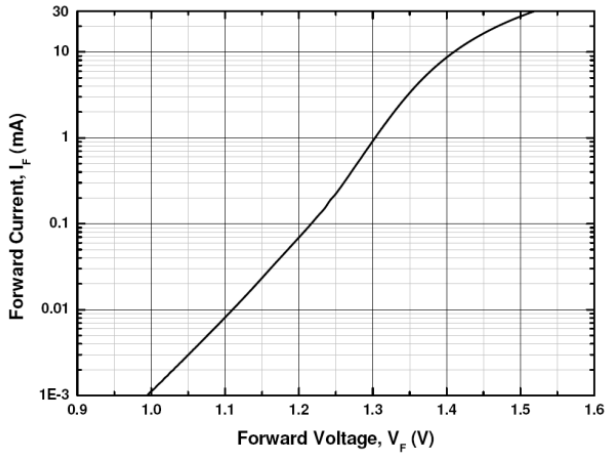

Figure 2. Low Level Output Voltage vs Ambient Temperature

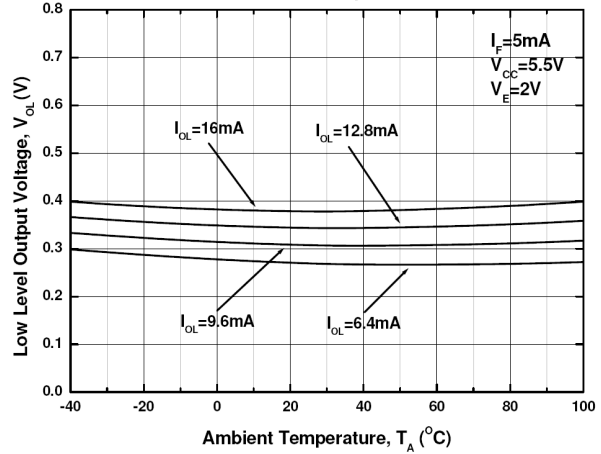

Figure 3. Low Level Output Current vs Ambient Temperature

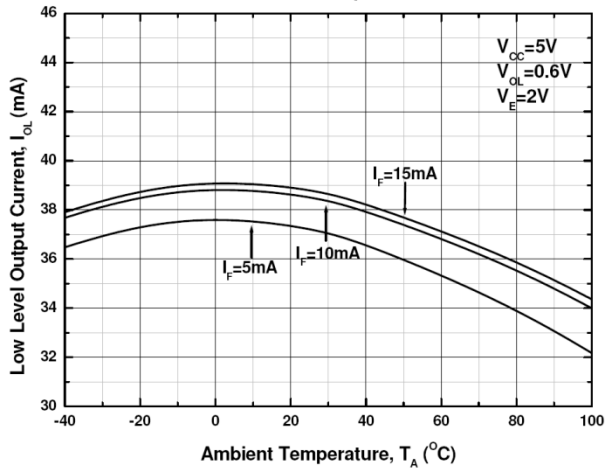

Figure 4. Input Threshold Current vs Ambient Temperature

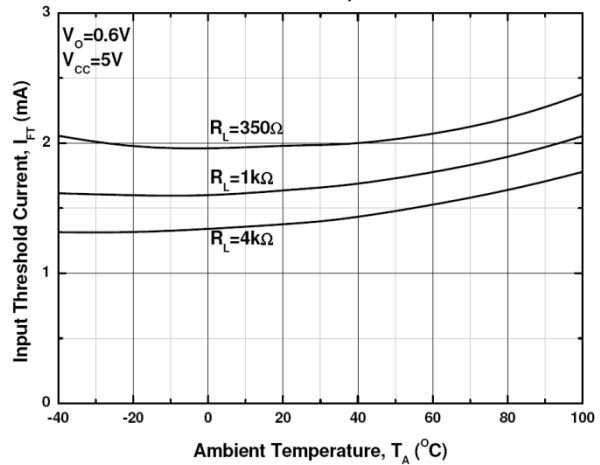

Figure 5. Input Current vs Output Voltage

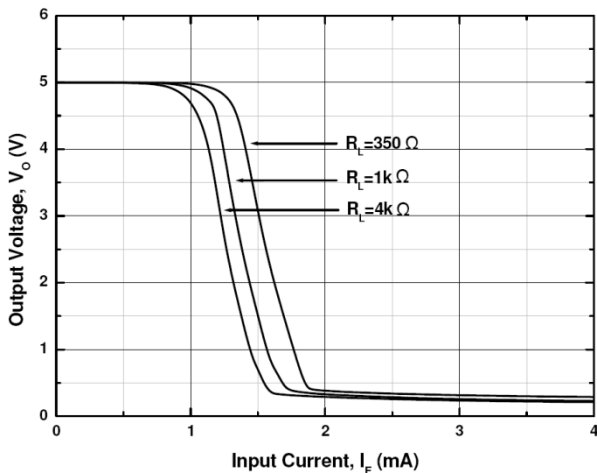

Figure 6. High Level Output Current vs Ambient Temperature

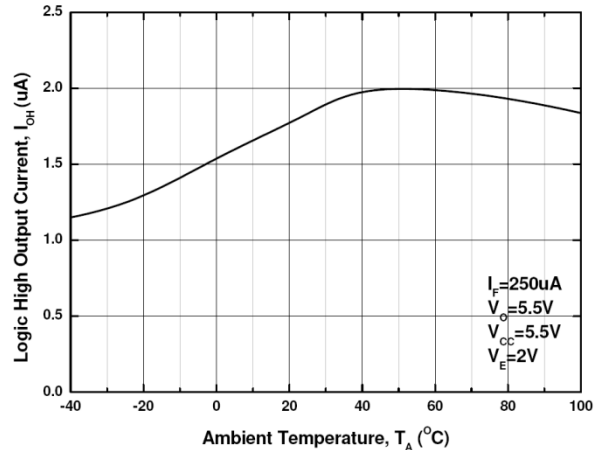

Figure 7. Propagation Delay vs. Forward Current

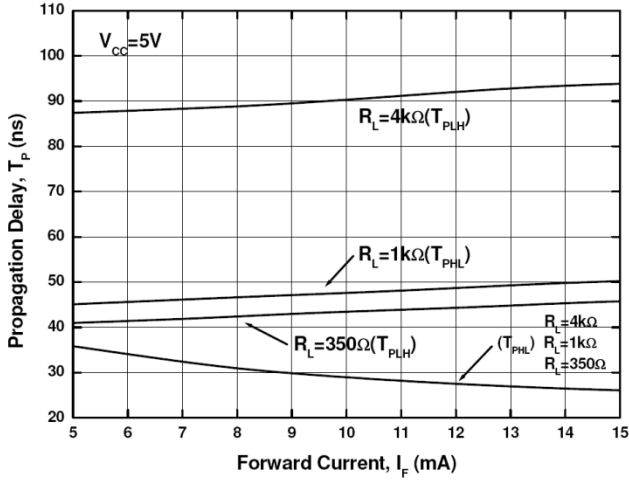

Figure 9. Pulse Width Distortion vs. Temperature

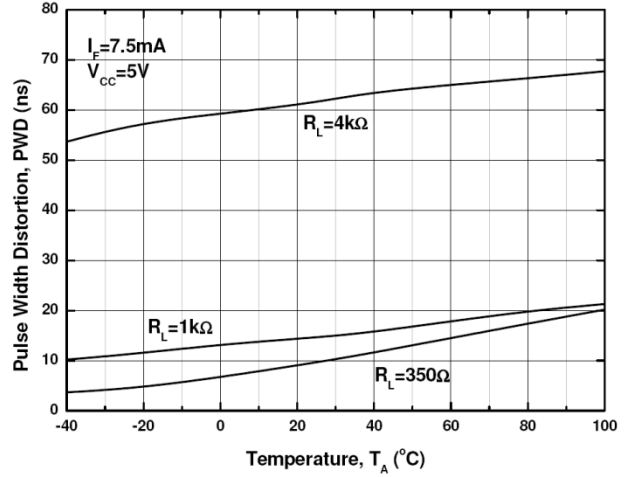

Figure 10. Rise and Fall Time vs. Temperature

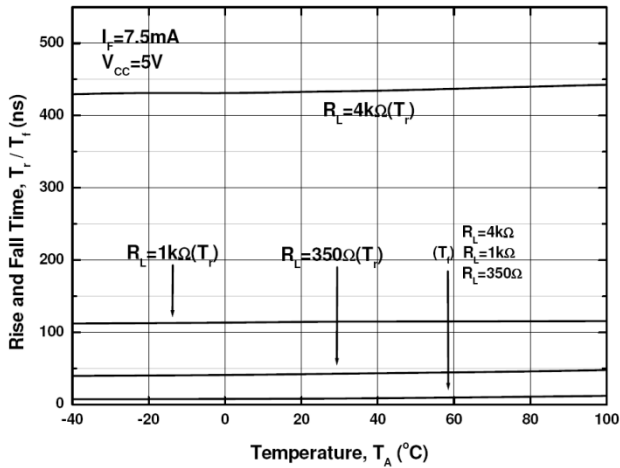

Fig. 11 Test circuit and waveforms for t_{PHL} , t_{PLH} , t_r , and t_f

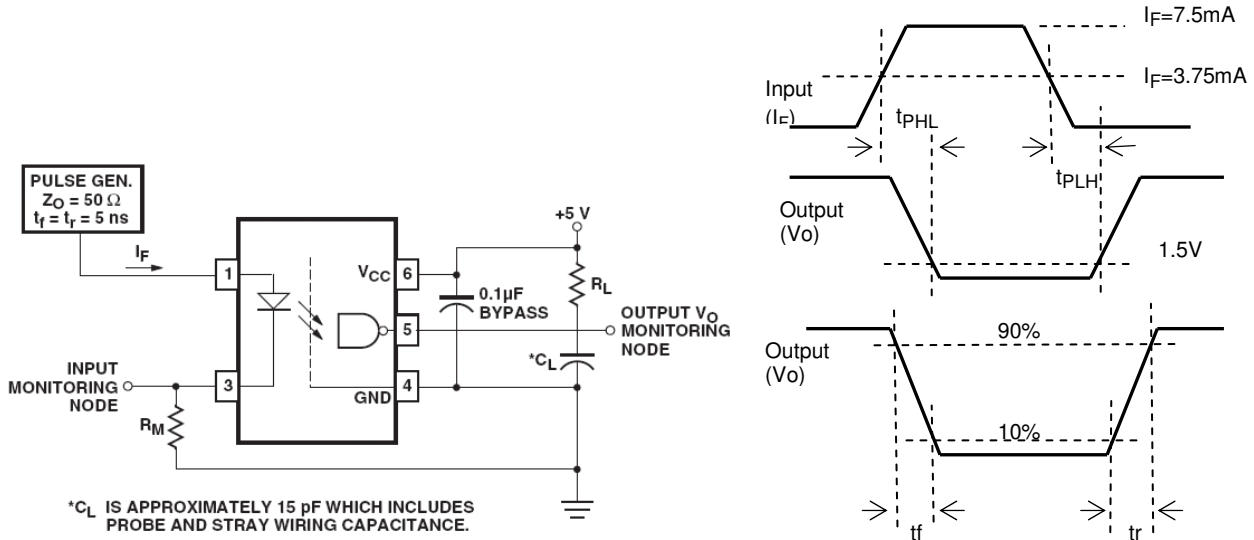
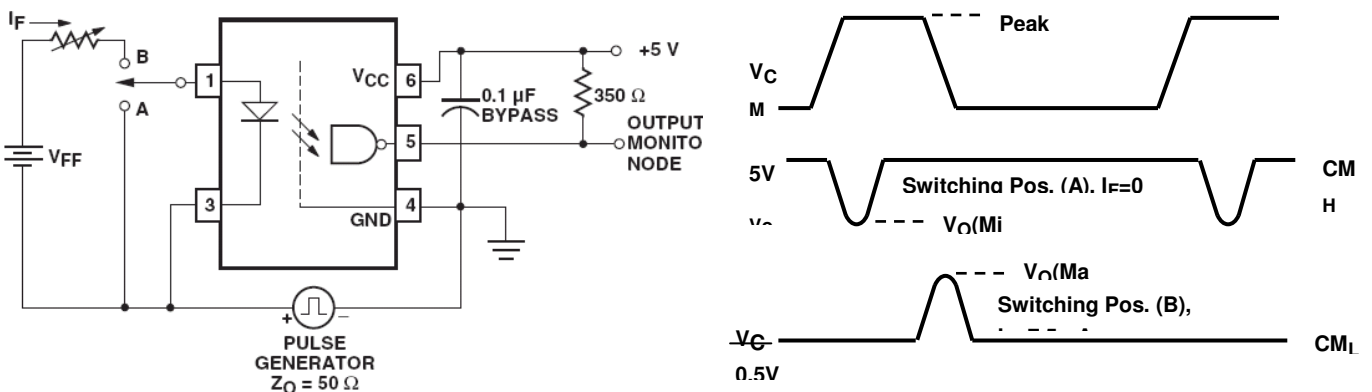

Fig. 12 Test circuit Common mode Transient Immunity



Notes:

- *3 The t_{PLH} propagation delay is measured from 3.75 mA point on the falling edge of the input pulse to the 1.5V point on the rising edge of the output pulse.
- *4 The t_{PHL} propagation delay is measured from 3.75 mA point on the rising edge of the input pulse to the 1.5 V point on the falling edge of the output pulse
- *5 t_{PSK} is equal to the magnitude of the worst case difference in t_{PHL} and/or t_{PLH} that will be seen between units at any given temperature within the worst case operating condition range.
- *6 CMH– The maximum tolerable rate of rise of the common mode voltage to ensure the output will remain in the HIGH state (i.e., $V_{OUT} > 2.0V$).
- *7 CML– The maximum tolerable rate of fall of the common mode voltage to ensure the output will remain in the LOW output state (i.e., $V_{OUT} < 0.8V$).

Order Information

Part Number

ELM6XX(Z)-V

Note

XX = Part no.(00, 01 or 11)

Z = Tape and reel option (TA, TB or none).

V = VDE (optional)

Option	Description	Packing quantity
None	Standard DIP-8	100 units per tube
(TA)	Surface mount lead form + TA tape & reel option	3000 units per reel
(TB)	Surface mount lead form + TB tape & reel option	3000 units per reel

Package Drawing

(Dimensions in mm)

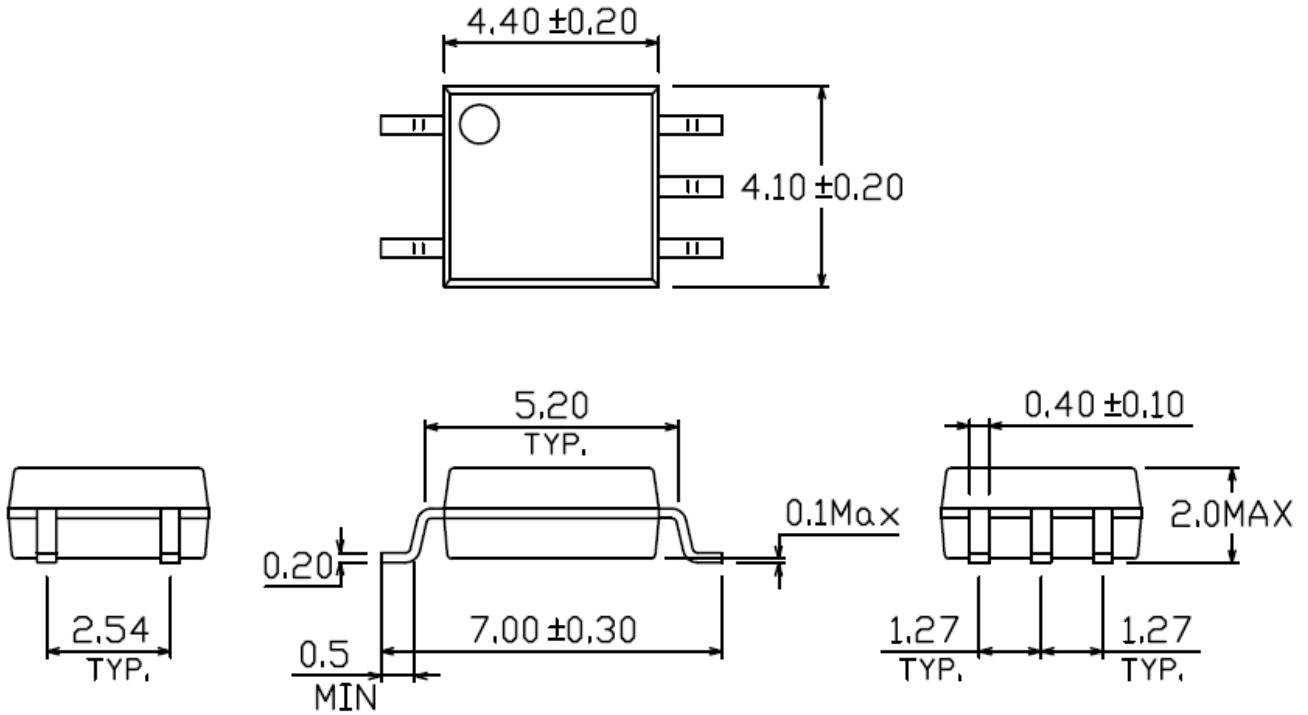

Recommended pad layout for surface mount leadform

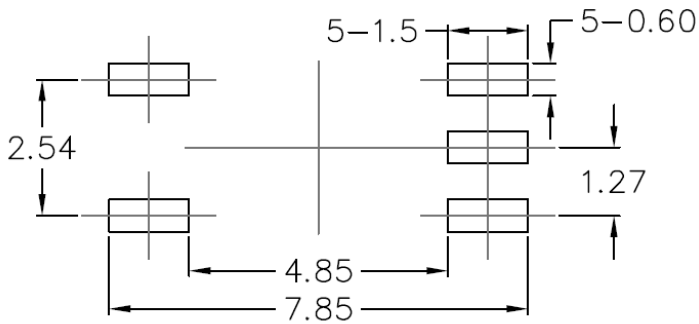

Device Marking



Notes

- M611 denotes Device Number
- Y denotes 1 digit Year code
- WW denotes 2 digit Week code
- V denotes VDE (optional)

Tape & Reel Packing Specifications

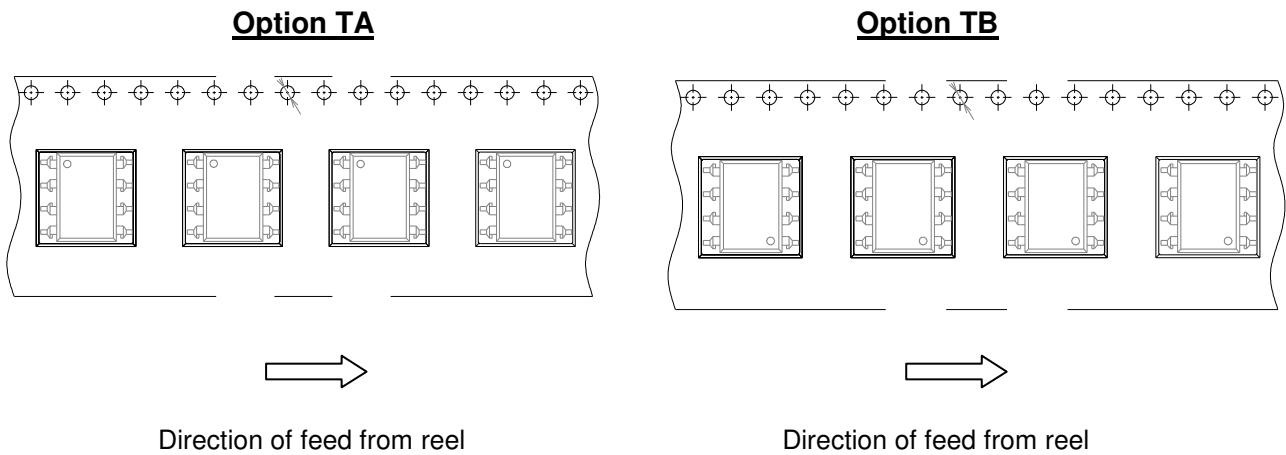

Tape dimensions

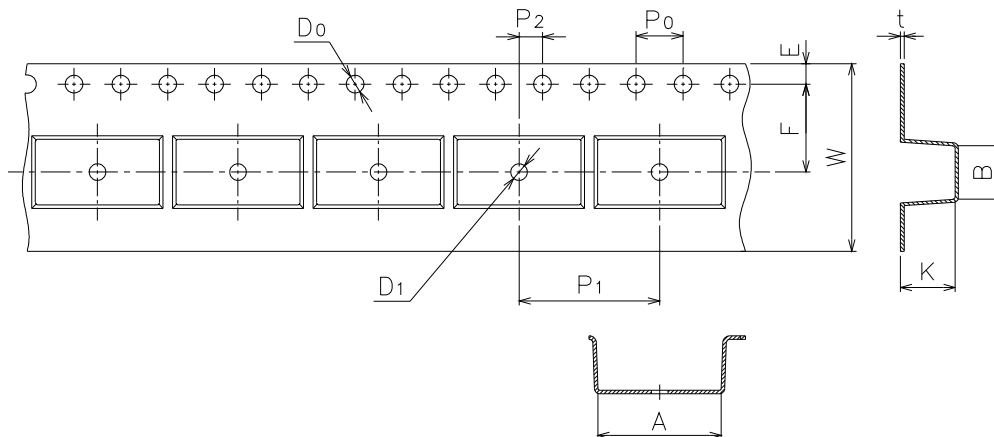

Dimension No.	A	B	Do	D1	E	F
Dimension(mm)	10.4±0.1	10.0±0.1	1.5±0.1	1.5±0.1	1.75±0.1	7.5±0.1
Dimension No.	Po	P1	P2	t	W	K
Dimension(mm)	4.0±0.1	12.0±0.1	2.0±0.1	0.4±0.1	16.0+0.3/ -0.1	4.5±0.1

Solder Reflow Temperature Profile

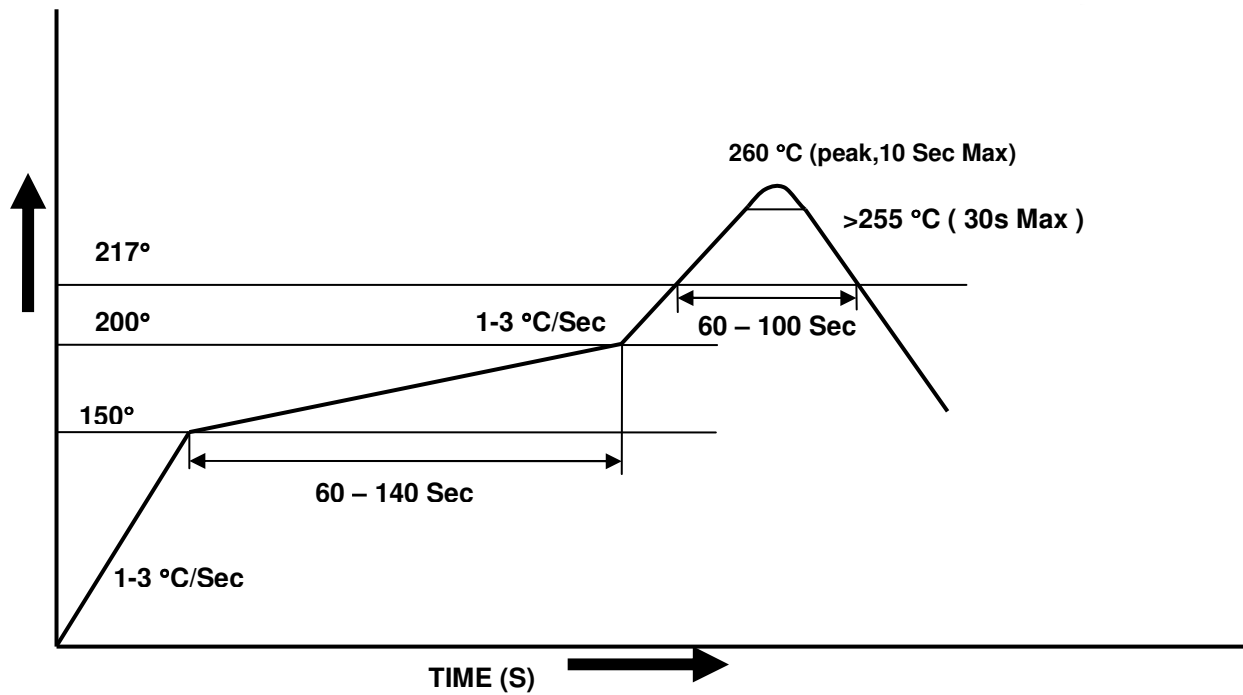

DISCLAIMER

1. Above specification may be changed without notice. EVERLIGHT will reserve authority on material change for above specification.
2. When using this product, please observe the absolute maximum ratings and the instructions for using outlined in these specification sheets. EVERLIGHT assumes no responsibility for any damage resulting from use of the product which does not comply with the absolute maximum ratings and the instructions included in these specification sheets.
3. These specification sheets include materials protected under copyright of EVERLIGHT corporation. Please don't reproduce or cause anyone to reproduce them without EVERLIGHT's consent.