

SMD Communication Crystal

Low profile SMD AT-cut quartz crystal in a ceramic package with a 2.0 mm x 1.6 mm foot print.



Product description

Miniature low profile AT-cut quartz crystal. True SMD style, ceramic package with nickel plated lid, seam welded. The product is supplied on tape and reel.

Applications

- Automotive
- GPS
- Communications
- Feature phone
- Consumer

Features

- Low aging
- Low hysteresis
- Wide temperature range

Specifications

1.0 SPECIFICATION REFERENCE

Line	Parameter	Description
1.1	Model description	RSX-11
1.2	RoHS compliant	Yes
1.3	Reference number	
1.4	Rakon part number	

2.0 FREQUENCY CHARACTERISTICS

Line	Parameter	Test Condition	Value	Unit
2.1	Frequency		19.2 to 52	MHz
2.2	Calibration tolerance	Frequency at 25°C ±2°C and specified load capacitance	±10 to 50	ppm
2.3	Reflow shift	Two consecutive reflows as per attached profile after 4 hours recovery at 25°C	±1 max	ppm
2.4	Frequency stability over temperature	Referenced to frequency reading at 25°C and the specified load capacitance	±15 to 50	ppm
2.5	Temperature range	Operating temperature	-40 to 85	°C
2.6	Frequency perturbations	Peak-to-peak deviation from the frequency versus temperature curve fit 5th order. Minimum of 1 frequency reading every 3°C over operating temperature range	1 max	ppm
2.7	Long term stability	Frequency drift over 1 year at 25°C	±1 max	ppm
2.8	g sensitivity	Gamma vector of all three axes from 30 Hz to 1500 Hz at 10 RMS	2 max	ppb/g

3.0 ELECTRICAL

Line	Parameter	Test Condition	Value	Unit
3.1	Load capacitance (CL)	Frequency is calibrated at room temperature	5 to 32	pF
3.2	Shunt capacitance (C0)	Operating specification	0.5 to 3	pF
3.3	Pull ability	Load and frequency dependant	0.5 min	ppm/pF
3.4	Drive level	Operating specification	30 max	µW
3.5	Equivalent series resistance (ESR)		85 max	Ω
3.6	Insulation resistance (IR)	100V ±15V at 25°C	500 min	MΩ

4.0 ENVIRONMENTAL

Line	Parameter	Description
4.1	Shock	Half sine-wave acceleration of 3000g peak amplitude. Duration: 0.3ms, Velocity: 12.3ft/s [MIL-STD-202 M213]
4.2	Moisture resistance	1000 hours at 85°C, 85% Relative Humidity. Biased. [MIL-STD-202 M106G]
4.3	Temperature cycling	1000 temperature cycles, where each cycle consists of a 25 minute soak time at -45°C followed by a 25 minute soak time at 85°C, with a 60 second maximum transition time between temperatures. Air to air transition. [JESD22 METHOD JA-104C]
4.4	Vibration	5g for 20 minutes. 12 cycles in each of 3 orientations. Test from 10-2000 Hz [JESD22-B103-B]
4.5	Storage temperature	-55 to 105°C

5.0 ENVIRONMENTAL

Line	Parameter	Description
5.1	Shock	2 cycle drop it onto concrete for six directions (x, y, z) and one corner. The height is 152 cm. Dummy is 120g weight.
5.2	Moisture Resistance	Temperature: 40°C ±2°C; Humidity : 90 ~ 95%; Time : for 240 hours; According to IEC 1178-1.4.8.15
5.3	Thermal Shock	100 temperature cycles, where each cycle consists of a 25 minute soak time at -40°C followed by a 25 minute soak time at 85°C, with a 60 second maximum transition time between temperatures. Air to air transition. According to IEC 1178-1.4.8.4
5.4	Vibration	Frequency: 10 ~ 55 Hz; Amplitude: 1.5 mm; Period: 1 min; Test time: X,Y,Z each direction 2h; According to IEC 1178-1.4.8.7
5.5	Storage temperature	-40 to 85°C

6.0 MANUFACTURING INFORMATION

Line	Parameter	Description
6.1	Washing	Able to withstand aqueous washing processes
6.2	Reflow	Able to withstand forced convection reflow process. Refer to "RSX/RGX crystals Pb-free Reflow" drawing
6.3	Packaging description	Tape and reel. Standard packing quantity is 4000 units per reel

7.0 MARKING

Line	Parameter	Description
7.1	Package	2.0 x 1.6 mm
7.2	Type	Laser engraved
7.3	Line 1	[R], [XX.XX]* = Frequency in MHz (e.g.: 8.000 = 8MHz, 19.20 = 19.2MHz, 100.0 = 100MHz)
7.4	Line 2	[o] = Pin 1, [F] = Factory code, [YMD] = Date code
7.5	* Frequency code	Frequency marking is only represented by the first four significant digits. For example, on a RSX-11 at 16.368MHz, its frequency marking will be 16.36MHz

Drawing Name: RSX-11 Model Drawing

MODEL OUTLINE

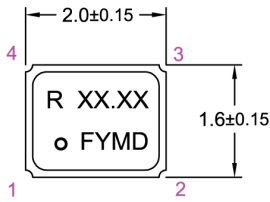

TOP VIEW

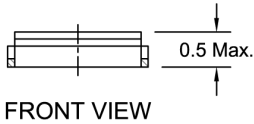

FRONT VIEW

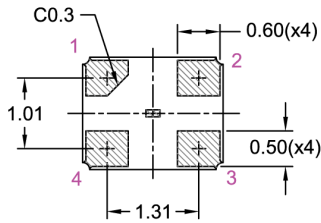

BOTTOM VIEW

MARKING EXAMPLE

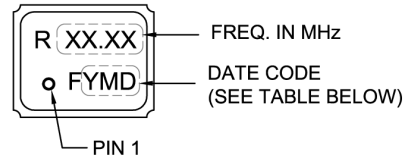

PIN CONNECTIONS

CONNECTIONS	
1	CRYSTAL
2	GND
3	CRYSTAL
4	GND

RECOMMENDED PAD LAYOUT - TOP VIEW

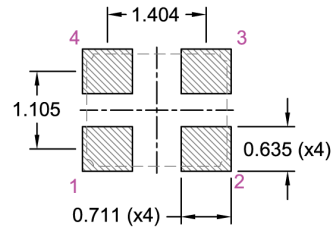

Y - Year Code

Code	Year	Code	Year
A	2010	N	2023
B	2011	O	2024
C	2012	P	2025
D	2013	Q	2026
E	2014	R	2027
F	2015	S	2028
G	2016	T	2029
H	2017	U	2030
I	2018	V	2031
J	2019	W	2032
K	2020	X	2033
L	2021	Y	2034
M	2022	Z	2035

M - Month Code

Code	Month
1	Jan
2	Feb
3	Mar
4	Apr
5	May
6	Jun
7	Jul
8	Aug
9	Sep
A	Oct
B	Nov
C	Dec

D - Day Code

Code	Day	Code	Day	Code	Day
1	1	E	14	R	27
2	2	F	15	S	28
3	3	G	16	T	29
4	4	H	17	U	30
5	5	I	18	V	31
6	6	J	19		
7	7	K	20		
8	8	L	21		
9	9	M	22		
A	10	N	23		
B	11	O	24		
C	12	P	25		
D	13	Q	26		

TITLE: RSX-11 MODEL

RELATED DRAWINGS:

FILENAME: CAT482

REVISION: E

DATE: 17-Oct-12

SCALE: 10 : 1

Millimetres

TOLERANCES:

XX =

X.X = ±0.2

X.XX = ±0.10

X.XXX = ±0.05

X° =

Hole =

rakon

© 2009 Rakon Limited

Drawing Name: RSX-11 Tape & Reel

TAPE DETAIL (Scale 5 : 1)

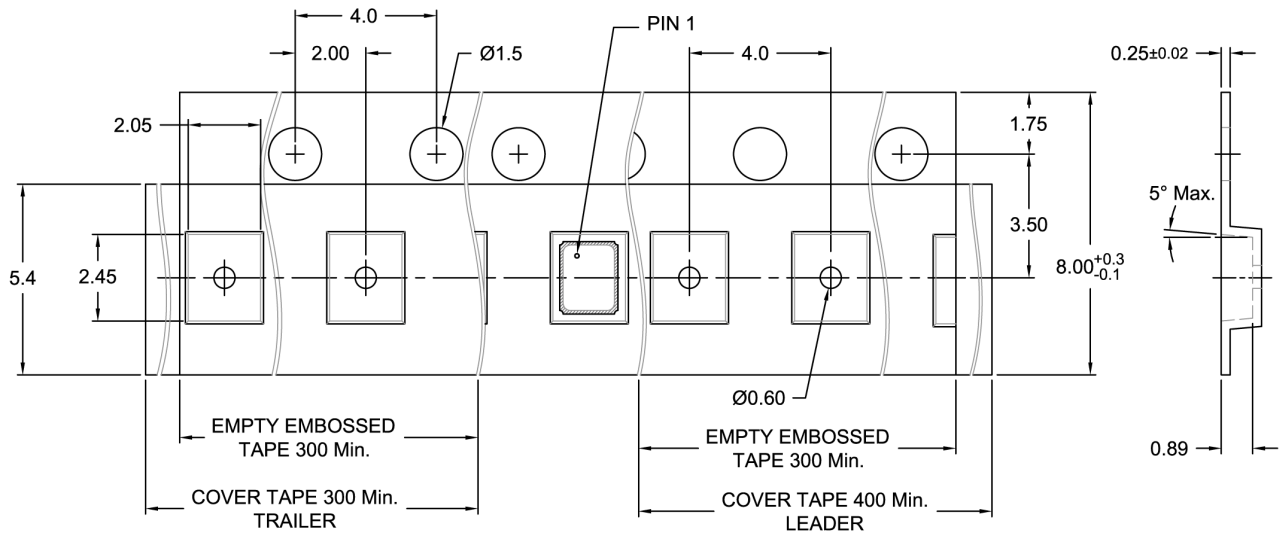

REEL DETAIL (Scale 1 : 2.5)

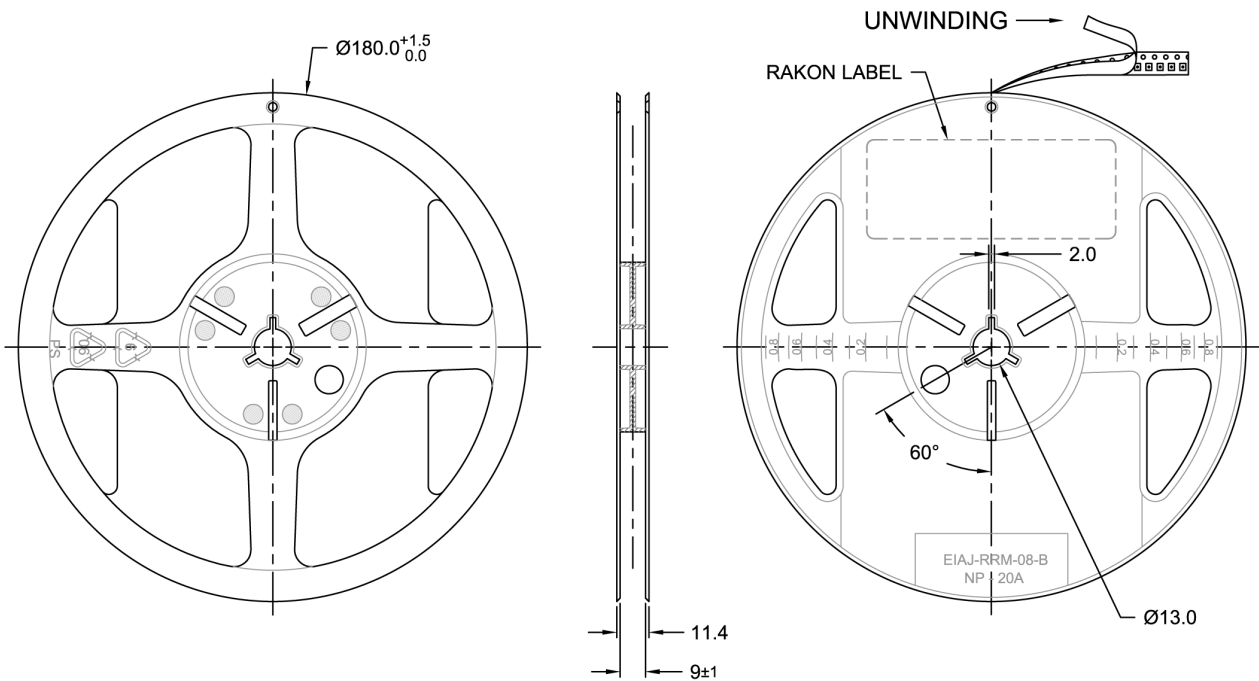

TITLE: 2016 SERIES CRYSTAL TAPE & REEL

RELATED DRAWINGS:

FILENAME: CAT518

REVISION: D

DATE: 22-Sep-11

SCALE: 5 : 1

Millimetres

TOLERANCES:

XX =

X.X = ± 0.1

X.XX = ± 0.05

X.XXX =

X° =

Hole =

rakon

© 2009 Rakon Limited

Drawing Name: RSX/RGX Crystals Pb-free Reflow

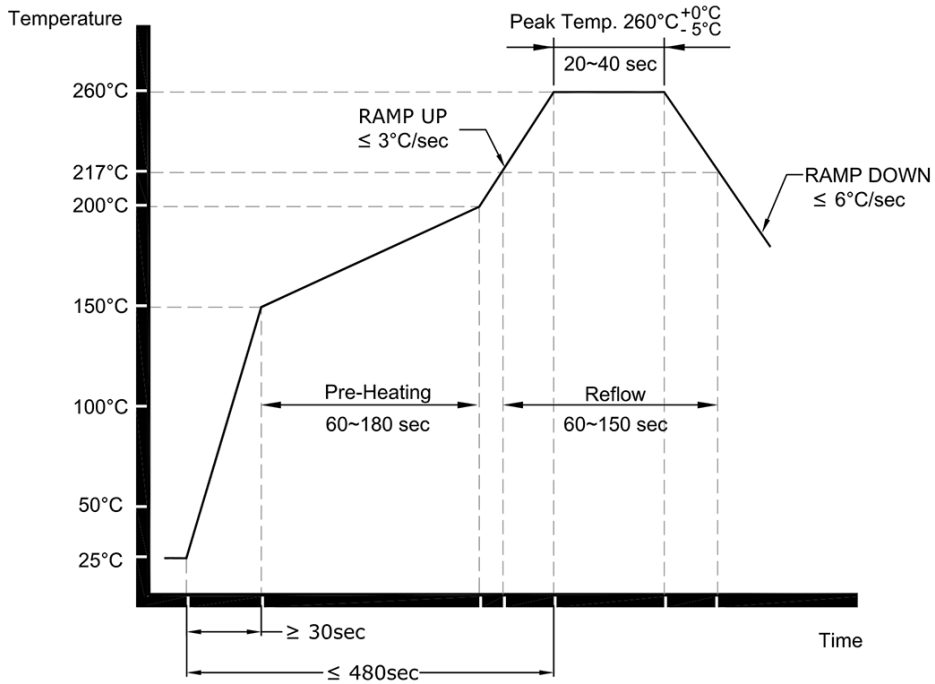

NOTE:

The product has been tested to withstand the Reflow Profile shown. The Reflow Profile used to solder Rakon RSX/RGX crystals are determined by the solder paste Manufacturer's specification. It is recommended that the Reflow Profile used does not exceed the one shown above.

TITLE: CRYSTAL Pb-FREE REFLOW

FILENAME: CAT353

RELATED DRAWINGS:

REVISION: B

DATE: 01-Feb-07

SCALE: NTS

Millimetres

rakon

© 2009 Rakon Limited