



Micro Commercial Components
 21201 Itasca Street Chatsworth
 CA 91311
 Phone: (818) 701-4933
 Fax: (818) 701-4939

SF31 THRU SF38

Features

- High Surge Capability
- Low Forward Voltage Drop
- High Current Capability
- High Reliability

3.0 Amp Super Fast Rectifier 50 to 600 Volts

Maximum Ratings

- Operating Temperature: -55°C to +125°C
- Storage Temperature: -55°C to +150°C
- For capacitive load, derate current by 20%

MCC Part Number	Maximum Recurrent Peak Reverse Voltage	Maximum RMS Voltage	Maximum DC Blocking Voltage
SF31	50V	35V	50V
SF32	100V	70V	100V
SF33	150V	105V	150V
SF34	200V	140V	200V
SF35	300V	210V	300V
SF36	400V	280V	400V
SF38	600V	420V	600V

DO-201AD

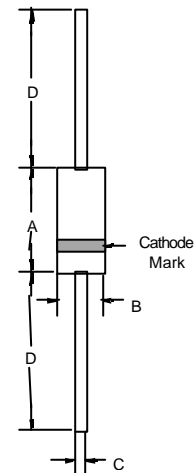

Electrical Characteristics @ 25°C Unless Otherwise Specified

Average Forward Current	$I_{F(AV)}$	3.0 A	$T_C = 55^\circ\text{C}$
Peak Forward Surge Current	I_{FSM}	100A	8.3ms, half sine
Maximum Instantaneous Forward Voltage	V_F	SF31-SF34 SF35-SF36 SF38	$I_{FM} = 3.0\text{A};$ $T_C = 25^\circ\text{C}$
		.95V	
		1.3V 1.7V	
Maximum DC Reverse Current At Rated DC Blocking Voltage	I_R	5.0 μA 100 μA	$T_C = 25^\circ\text{C}$ $T_C = 100^\circ\text{C}$
Typical Junction Capacitance	C_J	SF31-SF34 SF35-SF38	Measured at 1.0MHz, $V_R=4.0\text{V}$
		100pF 80pF	
Maximum Reverse Recovery Time	T_{rr}	35ns	$I_F=0.5\text{A}, I_R=1.0\text{A},$ $I_{rr}=0.25\text{A}$

*Pulse Test: Pulse Width 300 μsec , Duty Cycle 1%

DIM	DIMENSIONS				NOTE
	INCHES		MM		
	MIN	MAX	MIN	MAX	
A	---	.370	---	9.50	
B	---	.250	---	6.40	
C	.048	.052	1.20	1.30	
D	1.000	---	25.40	---	

SF31 thru SF38

Figure 1
Typical Reverse Characteristics

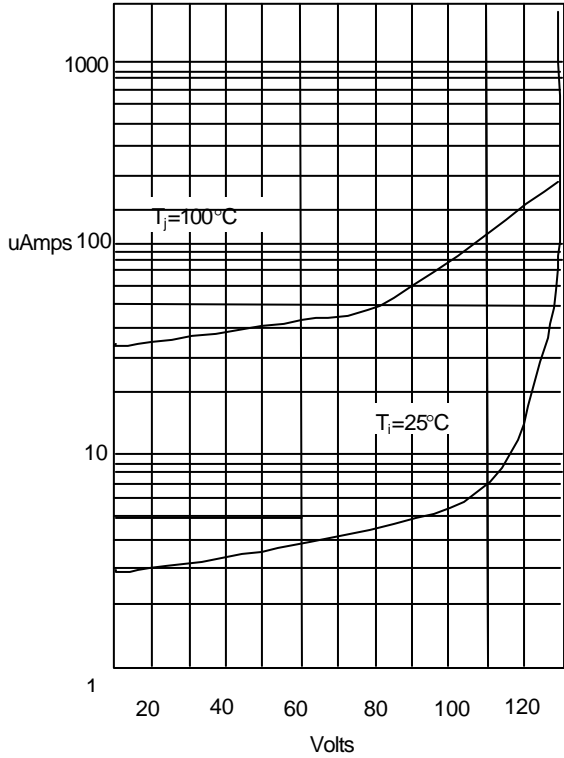

Instantaneous Reverse Current - uAmperes versus
Percent of Rated Peak Reverse Voltage - %

Figure 2
Typical Forward Characteristics

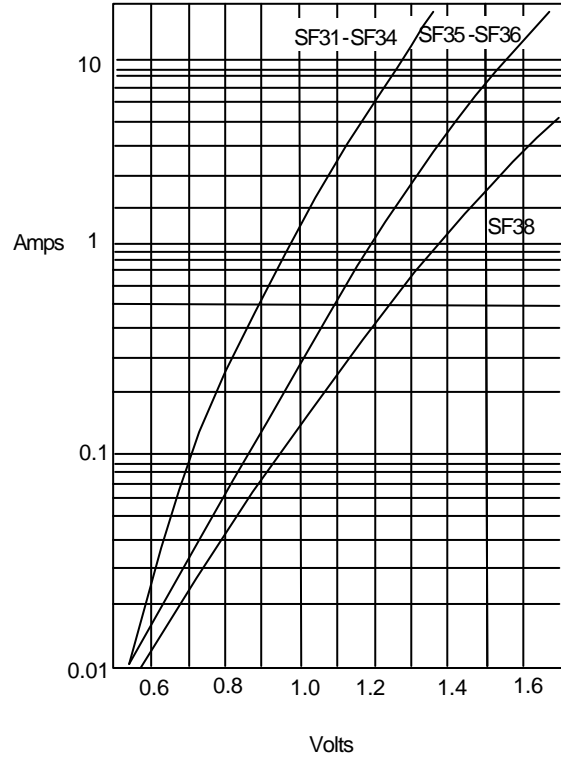

Instantaneous Forward Current - Amperes versus
Instantaneous Forward Voltage - Volts

Figure 3
Forward Derating Curve

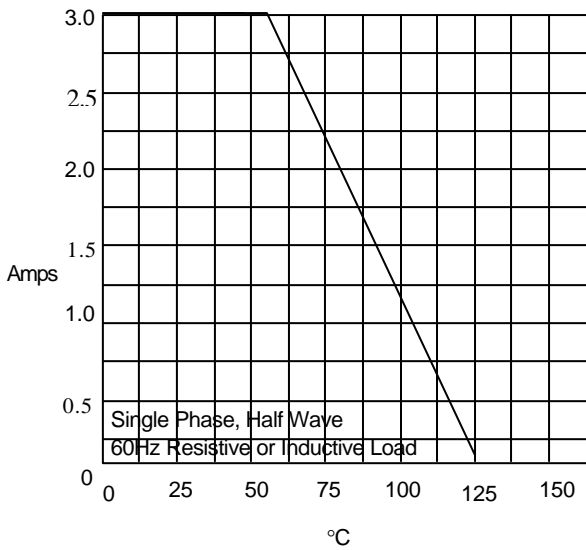

Average Forward Rectified Current Per Leg - Amperes versus
Case Temperature - °C

SF31 thru SF38

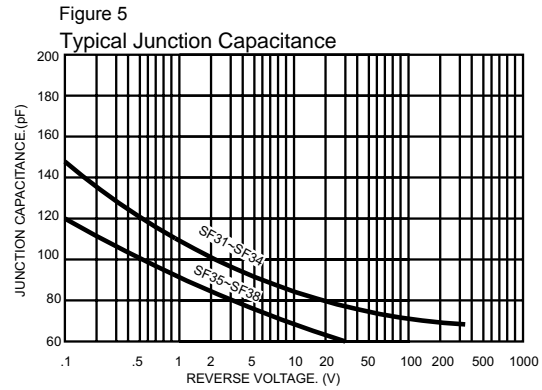
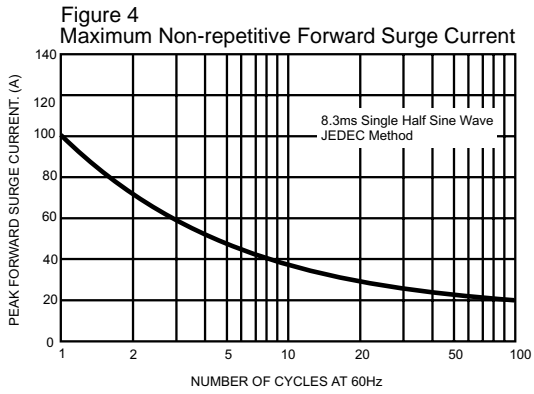
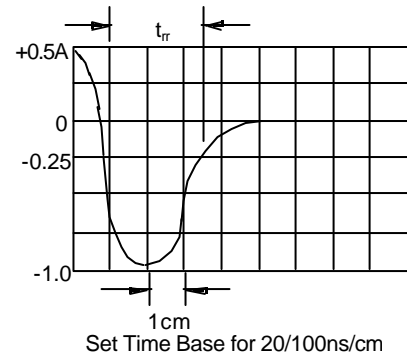
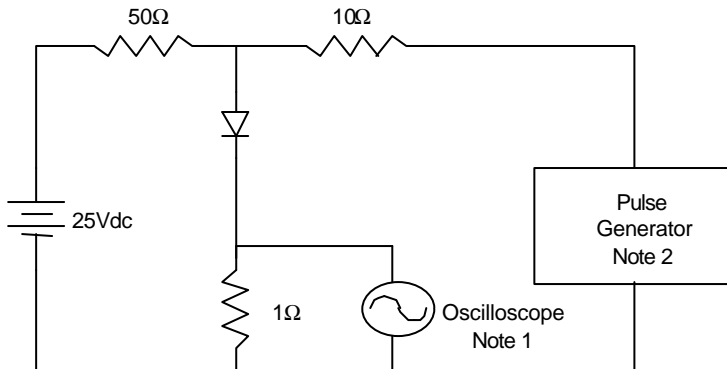

Figure 6
Reverse Recovery Time Characteristic And Test Circuit Diagram



- Notes:
1. Rise Time = 7ns max.
Input impedance = 1 megohm, 22pF
 2. Rise Time = 10ns max.
Source impedance = 50 ohms
 3. Resistors are non-inductive