

## 4 PIN SOP LOW OUTPUT CAPACITANCE SOLID STATE RELAY

PS7200J-1A

### FEATURES

- **1 CHANNEL TYPE**  
1A output
- **LOW C X R**  
 $C \times R = 15 \text{ pF} \cdot \Omega$
- **LOW OUTPUT CAPACITANCE**  
 $C_{OUT} = 1.7 \text{ pF TYP}$
- **LOW OFF-STATE LEAKAGE CURRENT**  
 $I_{LOFF} = 0.02 \text{ nA TYP}$
- **HIGH SPEED TURN-ON TIME**  
 $t_{ON} = 8 \mu\text{s TYP}$
- **DESIGNED FOR AC/DC SWITCHING LINE CHANGER**
- **SMALL PACKAGE**  
4 pin SOP
- **HIGH ISOLATION VOLTAGE**  
 $BV = 1500 \text{ Vr.m.s.}$
- **LOW OFFSET VOLTAGE**
- **AVAILABLE IN TAPE AND REEL**  
PS7200J-1A-E3, E4, F3, F4

### DESCRIPTION

The PS7200J-1A is a low output capacitance solid state relay containing a GaAs LED on the light emitting side (input side) and MOSFETs on the output side.

It is suitable for high-frequency signal control, due to its low C x R and low output capacitance. This device is not recommended for new designs. It has been replaced by the PS7200R.

### APPLICATIONS

- MEASUREMENT EQUIPMENT
- HIGH SPEED COMMUNICATIONS EQUIPMENT

### ELECTRICAL CHARACTERISTICS<sup>1</sup> ( $T_A = 25 \text{ }^\circ\text{C}$ )

		PART NUMBER	PS7200J-1A			
SYMBOLS		PARAMETERS	UNITS	MIN	TYP	MAX
Diode	$V_F$	Forward Voltage, $I_F = 10 \text{ mA}$	V		1.2	1.4
	$I_R$	Reverse Current, $V_R = 5 \text{ V}$	$\mu\text{A}$			5.0
MOS FET	$I_{LOFF}$	Off-State Leakage Current, $V_D = 40 \text{ V}$	$\mu\text{A}$			3.0
	$C_{OUT}$	Output Capacitance, $V = 0 \text{ V}$ , $f = 1 \text{ MHz}$	pF		1.7	
Coupled	$I_{FON}$	LED On-State Current, $I_L = 100 \text{ mA}$	mA			2
	$R_{ON}$	On-State Resistance, $I_F = 10 \text{ mA}$ , $I_L = 10 \text{ mA}$	$\Omega$		8.5	15
		$I_F = 10 \text{ mA}$ , $I_L = 100 \text{ mA}$	$\Omega$		8.5	15
	$t_{ON}$	Turn-on Time, $I_F = 10 \text{ mA}$ , $V_O = 5 \text{ V}$ , $PW \geq 10 \text{ ms}$	ms		0.008	1.0
	$t_{OFF}$	Turn-off Time, $I_F = 10 \text{ mA}$ , $V_O = 5 \text{ V}$ , $PW \geq 10 \text{ ms}$	ms		0.3	100
	$R_{i-o}$	Isolation Resistance, $V_{i-o} = 1.0 \text{ kVDC}$	$\Omega$		$10^9$	
$C_{i-o}$	Isolation Capacitance, $V = 0 \text{ V}$ , $f = 1 \text{ MHz}$	pF		0.5		

Note:

1. Turn-On, Turn-Off Time

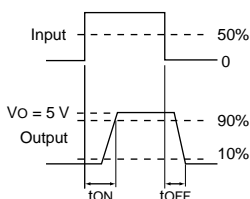

PS7200J-1A

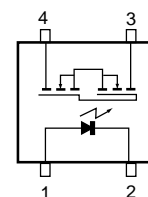

**ABSOLUTE MAXIMUM RATINGS<sup>1</sup>** (T<sub>A</sub> = 25°C)

SYMBOLS	PARAMETERS	UNITS	RATINGS
Diode			
I <sub>F</sub>	Forward Current (DC)	mA	50
V <sub>R</sub>	Reverse Voltage	V	5.0
P <sub>D</sub>	Power Dissipation	mW	50
I <sub>FP</sub>	Peak Forward Current <sup>2</sup>	A	1
MOSFET			
V <sub>L</sub>	Break Down Voltage	V	40
I <sub>L</sub>	Continuous Load Current	mA	100
P <sub>D</sub>	Power Dissipation	mW	100
Coupled			
BV	Isolation Voltage <sup>3</sup>	Vr.m.s.	1500
P <sub>T</sub>	Total Power Dissipation	mW	150
T <sub>A</sub>	Operating Ambient Temp.	°C	-40 to +80
T <sub>STG</sub>	Storage Temperature	°C	-40 to +100

Notes:

1. Operation in excess of any one of these parameters may result in permanent damage.
2. PW = 100 μs, Duty Cycle = 1 %
3. AC voltage for 1 minute at T<sub>A</sub> = 25 °C, RH = 60 % between input and output.

**RECOMMENDED OPERATING CONDITIONS** (T<sub>A</sub> = 25°C)

PART NUMBER		PS7200J-1A			
SYMBOLS	PARAMETERS	UNITS	MIN	TYP	MAX
I <sub>F</sub>	LED Operating Current	mA	2	10	20
V <sub>F</sub>	LED Off Voltage	V	0		0.5

**TYPICAL PERFORMANCES CURVES** (T<sub>A</sub> = 25°C)

**MAXIMUM FORWARD CURRENT vs. AMBIENT TEMPERATURE**

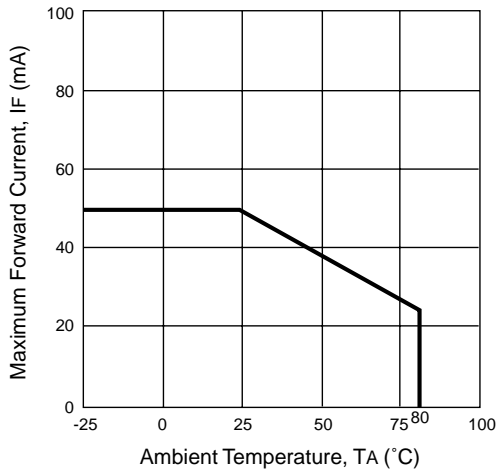

**MAXIMUM LOAD CURRENT vs. AMBIENT TEMPERATURE**

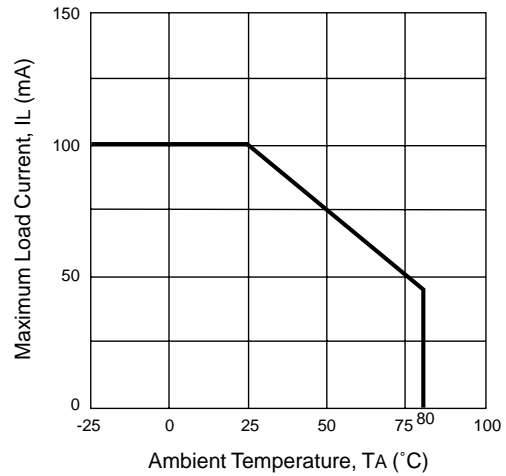

**FORWARD VOLTAGE vs. AMBIENT TEMPERATURE**

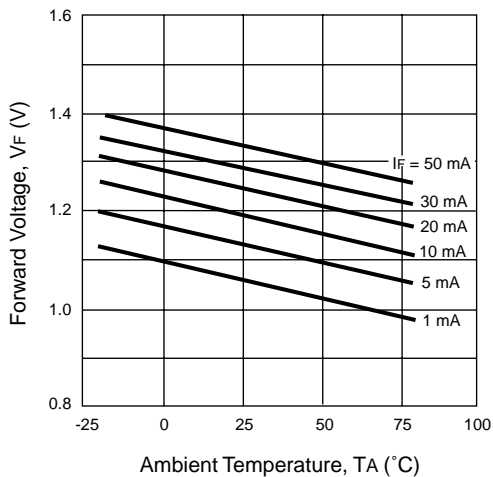

**OUTPUT CAPACITANCE vs. SUPPLY VOLTAGE**

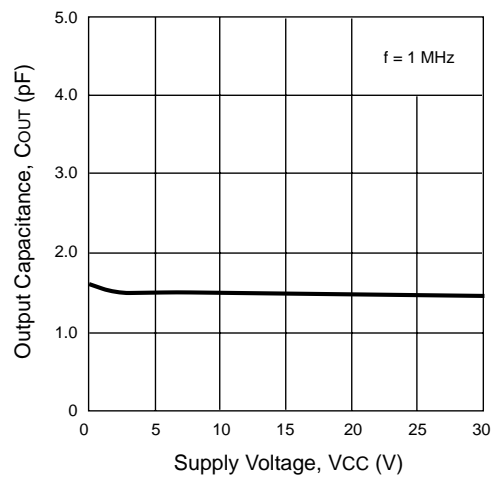

TYPICAL PERFORMANCE CURVES (TA = 25°C)

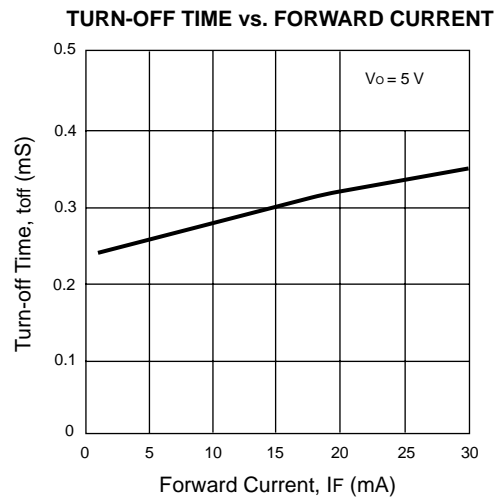
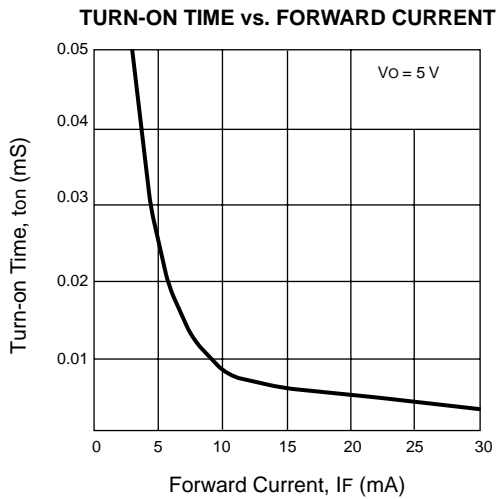
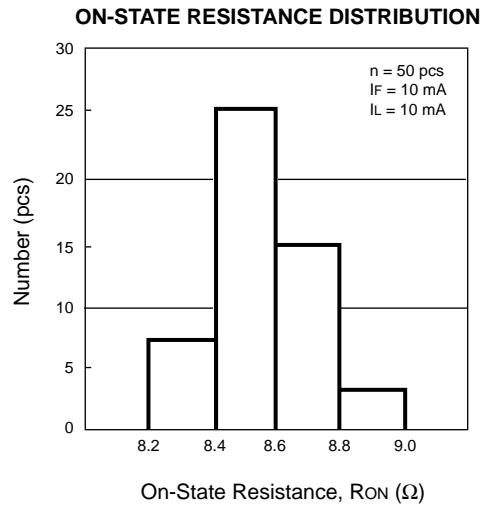
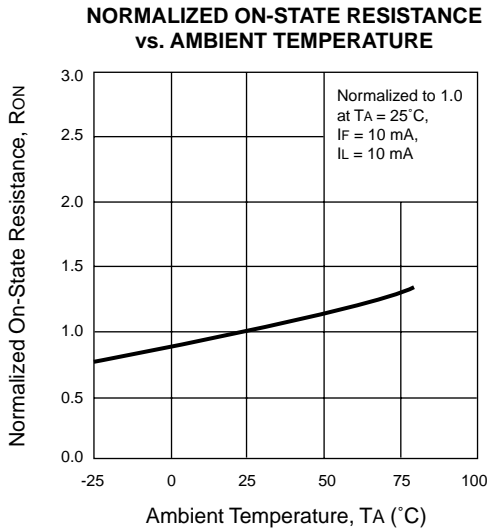
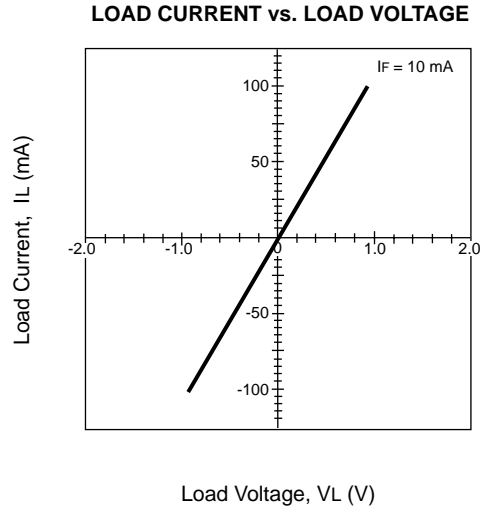
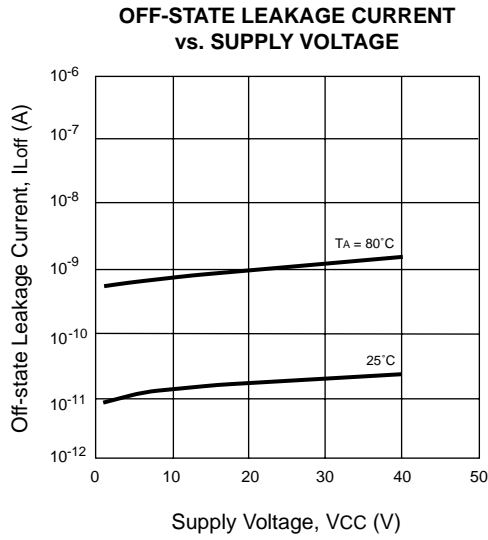

**TYPICAL PERFORMANCE CURVES** (TA = 25°C)

**TURN-ON TIME DISTRIBUTION**

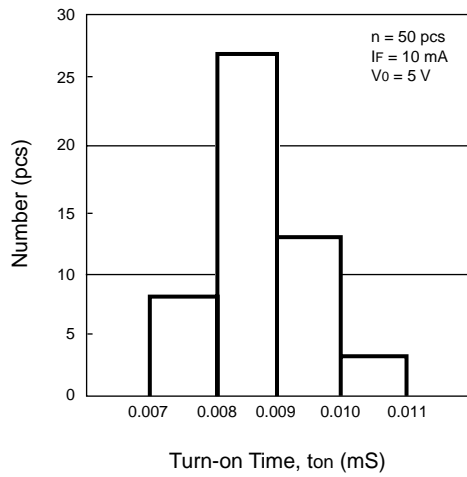

**TURN-OFF TIME DISTRIBUTION**

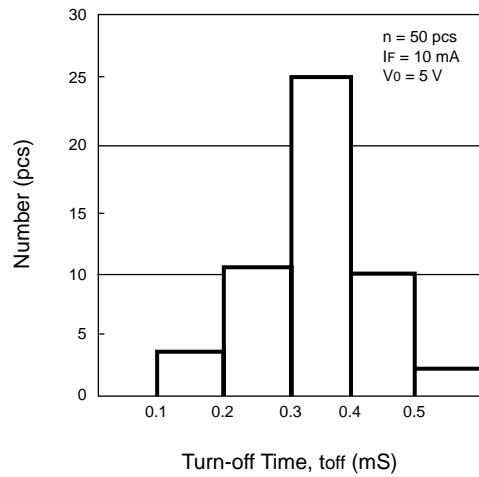

**NORMALIZED TURN-ON TIME vs. AMBIENT TEMPERATURE**

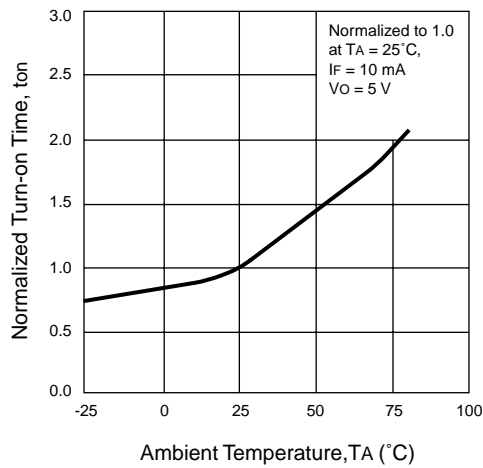

**NORMALIZED TURN-OFF TIME vs. AMBIENT TEMPERATURE**

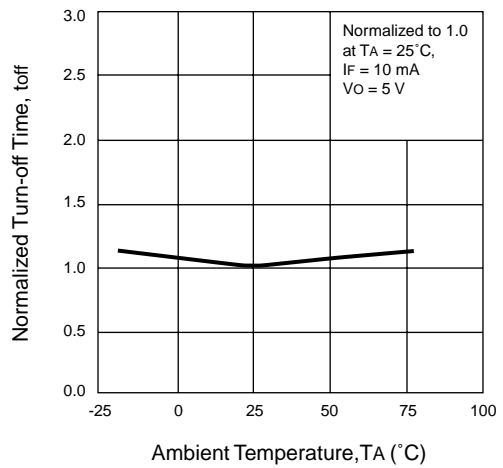

**INSERTION LOSS vs. FREQUENCY**

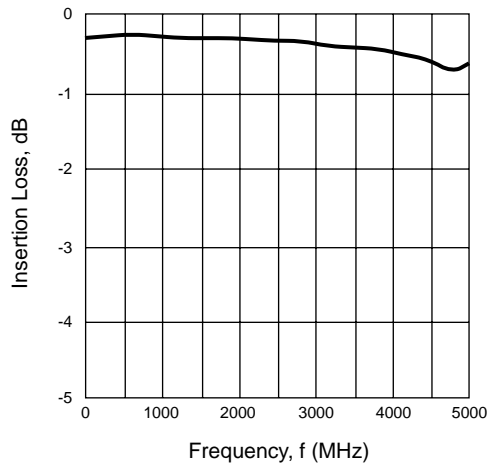

**ISOLATION vs. FREQUENCY**

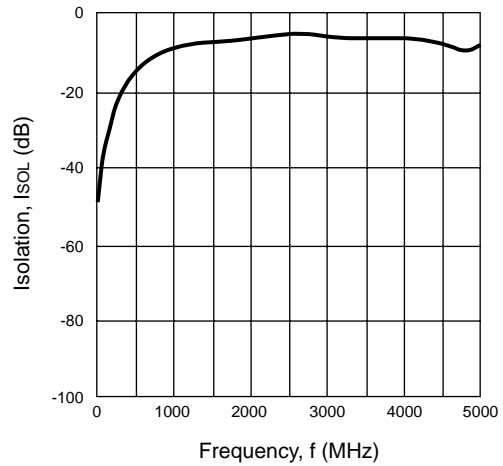

# PS7200J-1A

## OUTLINE DIMENSIONS (Units in mm)

PS7200J-1A

(Top View)

1. LED Anode
2. LED Cathode
3. MOSFET
4. MOSFET

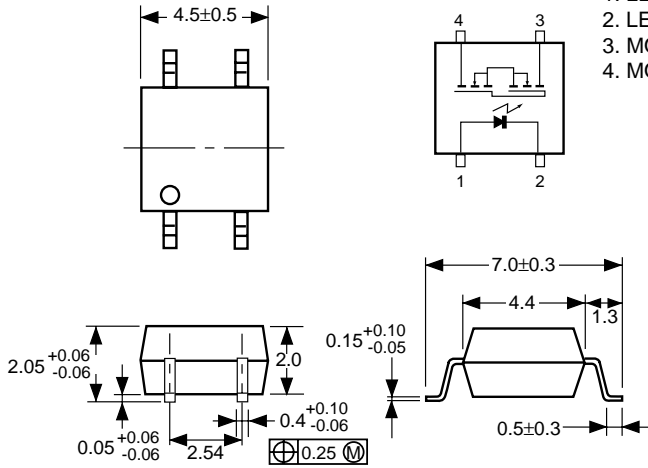

## TAPING SPECIFICATIONS (Units in mm)

OUTLINE AND DIMENSIONS (TAPE)

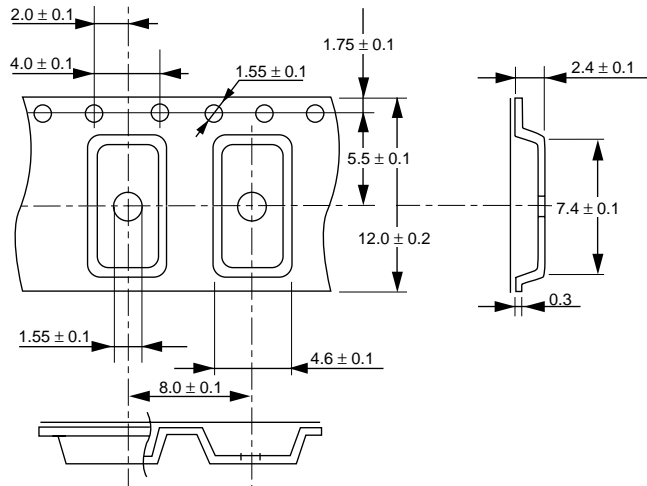

OUTLINE AND DIMENSIONS (REEL)

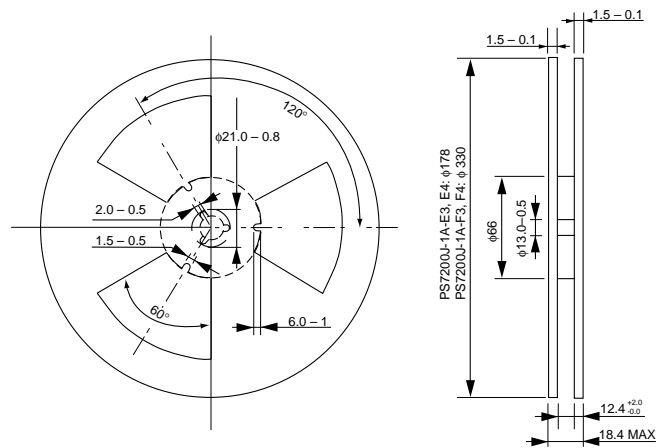

Notes:

- |              |                   |           |
|--------------|-------------------|-----------|
| 1. Packing : | PS7200J-1A-E3, E4 | 900 pcs.  |
|              | PS7200J-1A-F3, F4 | 3500 pcs. |

TAPE DIRECTION

PS7200J-1A-E3  
PS7200J-1A-F3

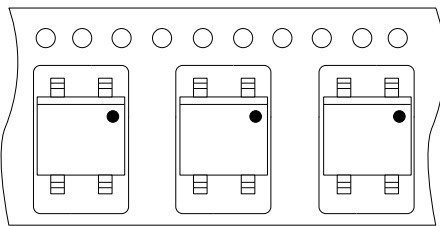

PS7200J-1A-E4  
PS7200J-1A-F4

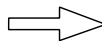
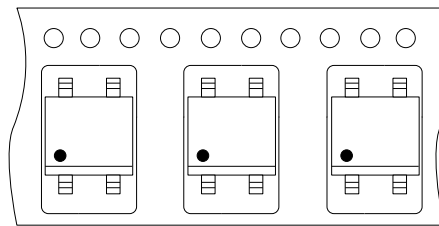

EXCLUSIVE NORTH AMERICAN AGENT FOR **NEC** RF, MICROWAVE & OPTOELECTRONIC SEMICONDUCTORS

**CEL** CALIFORNIA EASTERN LABORATORIES • Headquarters • 4590 Patrick Henry Drive • Santa Clara, CA 95054-1817 • (408) 988-3500 • Telex 34-6393 • FAX (408) 988-0279  
24-Hour Fax-On-Demand: 800-390-3232 (U.S. and Canada only) • Internet: <http://WWW.CEL.COM>

DATA SUBJECT TO CHANGE WITHOUT NOTICE

11/30/01