

NOTES:

- INSULATOR MATERIAL - POLYPHENYLENE SULPHIDE, UL 94V-0
- CONTACT MATERIAL - PHOSPHOR BRONZE ALLOY
- CONTACT PLATING - GOLD OVER NICKEL UNDERPLATE
- MOUNTING OPTION - 01-No Mounting Lugs
- CONTACT TYPE - 542-Wire Wrap .045 Sq.(1.14 Sq.) - Tail LG=.750(19.05)

TOLERANCE UNLESS OTHERWISE SPECIFIED	
.XX	±.01
.XXX	±.005
.XXXX	±.0005

THIS IS A C.A.D. GENERATED DRAWING
DO NOT MAKE MANUAL REVISIONS TO MASTER.



ISSUE NUMBER	
ORIGINAL	①

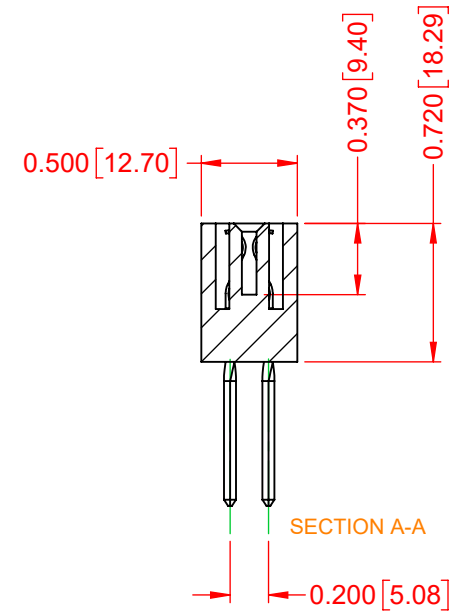
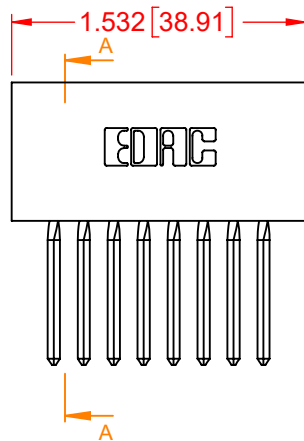
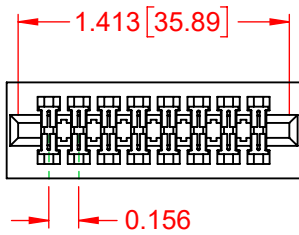

317 SERIES CARD EDGE CONNECTOR

ACAD REFERENCE NO.: 317 Assembly	
DRAWN: C.B	DATE: February 5, 2020
CHECKED:	DATE:
SCALE: 1:1	SHEET 1 OF 1
DRAWING NUMBER: 317-016-542-801	ISSUE
PART NUMBER: 317-016-542-801	1



THIS SERIES FULLY CONFORMS TO THE EUROPEAN UNION DIRECTIVES 2011/65/EU FOR RoHS COMPLIANCY.



EDAC INC
TORONTO, ONTARIO
CANADA
YOUR CONNECTION TO QUALITY & SERVICE

THESE DRAWINGS AND SPECIFICATIONS ARE THE PROPERTY OF EDAC INC., AND SHALL NOT BE REPRODUCED, OR COPIED OR USED AS THE BASIS FOR THE MANUFACTURE OR SALE OF APPARATUS WITHOUT WRITTEN PERMISSION.