

Standard Rectifier Module

3~ Rectifier	Brake Chopper
$V_{RRM} = 1600 \text{ V}$	$V_{CES} = 1200 \text{ V}$
$I_{DAV} = 180 \text{ A}$	$I_{C25} = 180 \text{ A}$
$I_{FSM} = 1100 \text{ A}$	$V_{CE(sat)} = 1.7 \text{ V}$

3~ Rectifier Bridge + Brake Unit

Part number

VUB120-16NOX

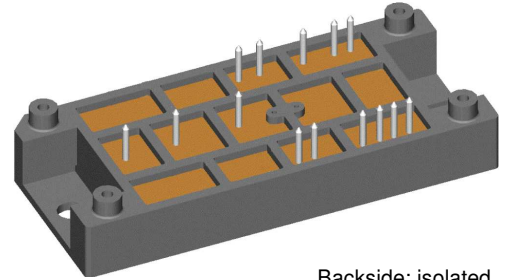

Backside: isolated

E72873

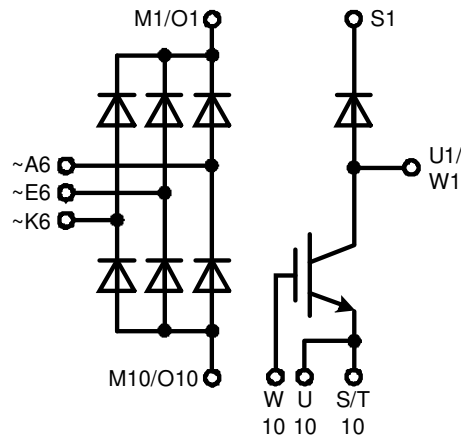

Features / Advantages:

- Package with DCB ceramic base plate
- Improved temperature and power cycling
- Planar passivated chips
- Very low forward voltage drop
- Very low leakage current
- X2PT - 2nd generation Xtreme light Punch Through
- Rugged X2PT design results in:
 - short circuit rated for 10 μsec .
 - very low gate charge
 - low EMI
 - square RBSOA @ 2x I_c
- Thin wafer technology combined with X2PT design results in a competitive low $V_{CE(sat)}$ and low thermal resistance

Applications:

- 3~ Rectifier with brake unit for drive inverters

Package: V2-Pack

- Isolation Voltage: 3600 V~
- Industry standard outline
- RoHS compliant
- Soldering pins for PCB mounting
- Height: 17 mm
- Base plate: DCB ceramic
- Reduced weight
- Advanced power cycling

Terms and Conditions of Usage

The data contained in this product data sheet is exclusively intended for technically trained staff. The user will have to evaluate the suitability of the product for the intended application and the completeness of the product data with respect to his application. The specifications of our components may not be considered as an assurance of component characteristics. The information in the valid application- and assembly notes must be considered. Should you require product information in excess of the data given in this product data sheet or which concerns the specific application of your product, please contact your local sales office.

Due to technical requirements our product may contain dangerous substances. For information on the types in question please contact your local sales office.

Should you intend to use the product in aviation, in health or life endangering or life support applications, please notify. For any such application we urgently recommend

- to perform joint risk and quality assessments;

- the conclusion of quality agreements;

- to establish joint measures of an ongoing product survey, and that we may make delivery dependent on the realization of any such measures.

Rectifier				Ratings			
Symbol	Definition	Conditions		min.	typ.	max.	Unit
V_{RSM}	max. non-repetitive reverse blocking voltage					1700	V
V_{RRM}	max. repetitive reverse blocking voltage					1600	V
I_R	reverse current	$V_R = 1600$ V		$T_{VJ} = 25^\circ\text{C}$		100	μA
		$V_R = 1600$ V		$T_{VJ} = 125^\circ\text{C}$		2	mA
V_F	forward voltage drop	$I_F = 60$ A		$T_{VJ} = 25^\circ\text{C}$		1.16	V
		$I_F = 180$ A				1.55	V
		$I_F = 60$ A		$T_{VJ} = 125^\circ\text{C}$		1.09	V
		$I_F = 180$ A				1.59	V
I_{DAV}	bridge output current	$T_C = 90^\circ\text{C}$	rectangular	$T_{VJ} = 150^\circ\text{C}$		180	A
			$d = \frac{1}{3}$				
V_{FO}	threshold voltage			$T_{VJ} = 150^\circ\text{C}$		0.81	V
r_F	slope resistance					4.4	m Ω
						} for power loss calculation only	
R_{thJC}	thermal resistance junction to case					0.6	K/W
R_{thCH}	thermal resistance case to heatsink				0.2		K/W
P_{tot}	total power dissipation			$T_C = 25^\circ\text{C}$		205	W
I_{FSM}	max. forward surge current	$t = 10$ ms; (50 Hz), sine		$T_{VJ} = 45^\circ\text{C}$		1.10	kA
		$t = 8,3$ ms; (60 Hz), sine		$V_R = 0$ V		1.19	kA
		$t = 10$ ms; (50 Hz), sine		$T_{VJ} = 150^\circ\text{C}$		935	A
		$t = 8,3$ ms; (60 Hz), sine		$V_R = 0$ V		1.01	kA
I^2t	value for fusing	$t = 10$ ms; (50 Hz), sine		$T_{VJ} = 45^\circ\text{C}$		6.05	kA ² s
		$t = 8,3$ ms; (60 Hz), sine		$V_R = 0$ V		5.89	kA ² s
		$t = 10$ ms; (50 Hz), sine		$T_{VJ} = 150^\circ\text{C}$		4.37	kA ² s
		$t = 8,3$ ms; (60 Hz), sine		$V_R = 0$ V		4.25	kA ² s
C_J	junction capacitance	$V_R = 400$ V; $f = 1$ MHz		$T_{VJ} = 25^\circ\text{C}$		37	pF

Brake IGBT + Diode				Ratings					
Symbol	Definition	Conditions	min.	typ.	max.	Unit			
V_{CES}	collector emitter voltage	$T_{VJ} = 25^{\circ}C$			1200	V			
V_{GES}	max. DC gate voltage				± 20	V			
V_{GEM}	max. transient gate emitter voltage				± 30	V			
I_{C25}	collector current	$T_C = 25^{\circ}C$			180	A			
I_{C80}		$T_C = 80^{\circ}C$			140	A			
P_{tot}	total power dissipation	$T_C = 25^{\circ}C$			500	W			
$V_{CE(sat)}$	collector emitter saturation voltage	$I_C = 100\text{ A}; V_{GE} = 15\text{ V}$			1.7	V			
					1.9	V			
$V_{GE(th)}$	gate emitter threshold voltage	$I_C = 4\text{ mA}; V_{GE} = V_{CE}$	6	6.8	7.5	V			
I_{CES}	collector emitter leakage current	$V_{CE} = V_{CES}; V_{GE} = 0\text{ V}$			0.1	mA			
					0.1	mA			
I_{GES}	gate emitter leakage current	$V_{GE} = \pm 20\text{ V}$			500	nA			
$Q_{G(on)}$	total gate charge	$V_{CE} = 600\text{ V}; V_{GE} = 15\text{ V}; I_C = 100\text{ A}$		340		nC			
$t_{d(on)}$	turn-on delay time	inductive load $V_{CE} = 600\text{ V}; I_C = 100\text{ A}$ $V_{GE} = \pm 15\text{ V}; R_G = 6.8\ \Omega$							
t_r	current rise time						$T_{VJ} = 125^{\circ}C$	230	ns
$t_{d(off)}$	turn-off delay time						70	ns	
t_f	current fall time						380	ns	
E_{on}	turn-on energy per pulse						230	mJ	
E_{off}	turn-off energy per pulse						12.5	mJ	
E_{off}		11.5	mJ						
RBSOA	reverse bias safe operating area	$V_{GE} = \pm 15\text{ V}; R_G = 6.8\ \Omega$							
I_{CM}		$V_{CEK} = 1200\text{ V}$			300	A			
SCSOA	short circuit safe operating area	$V_{CEK} = 1200\text{ V}$							
t_{SC}	short circuit duration	$V_{CE} = 720\text{ V}; V_{GE} = \pm 15\text{ V}$			10	μs			
I_{SC}	short circuit current	$R_G = 6.8\ \Omega$; non-repetitive		450		A			
R_{thJC}	thermal resistance junction to case				0.25	K/W			
R_{thCH}	thermal resistance case to heatsink				0.10	K/W			
Brake Diode									
V_{RRM}	max. repetitive reverse voltage	$T_{VJ} = 25^{\circ}C$			1200	V			
I_{F25}	forward current	$T_C = 25^{\circ}C$			48	A			
I_{F80}		$T_C = 80^{\circ}C$			32	A			
V_F	forward voltage	$I_F = 30\text{ A}$			2.75	V			
					1.60	V			
I_R	reverse current	$V_R = V_{RRM}$			0.25	mA			
					1	mA			
Q_{rr}	reverse recovery charge	$V_R = 600\text{ V}$ $-di_f/dt = 1000\text{ A}/\mu s$ $I_F = 30\text{ A}$							
I_{RM}	max. reverse recovery current						$T_{VJ} = 125^{\circ}C$	5.2	μC
t_{rr}	reverse recovery time						50	A	
E_{rec}	reverse recovery energy						300	ns	
					1.9	mJ			
R_{thJC}	thermal resistance junction to case				0.9	K/W			
R_{thCH}	thermal resistance case to heatsink				0.3	K/W			

Package V2-Pack				Ratings		
Symbol	Definition	Conditions	min.	typ.	max.	Unit
I_{RMS}	RMS current	per terminal			100	A
T_{VJ}	virtual junction temperature		-40		150	°C
T_{op}	operation temperature		-40		125	°C
T_{stg}	storage temperature		-40		125	°C
Weight				76		g
M_D	mounting torque		2		2.5	Nm
$d_{Spp/APP}$	creepage distance on surface / striking distance through air	terminal to terminal	6.0			mm
$d_{Spb/APb}$		terminal to backside	12.0			mm
V_{ISOL}	isolation voltage	t = 1 second 50/60 Hz, RMS; $I_{ISOL} \leq 1$ mA	3600			V
		t = 1 minute	3000			V

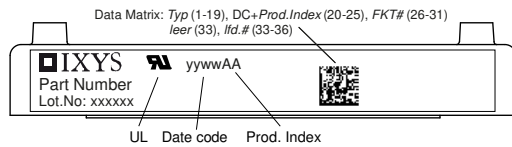

Ordering	Ordering Number	Marking on Product	Delivery Mode	Quantity	Code No.
Standard	VUB120-16NOX	VUB120-16NOX	Box	6	520475

Similar Part	Package	Voltage class
VUB120-16NOXT	V2-Pack	1600

Equivalent Circuits for Simulation			* on die level	$T_{VJ} = 150^\circ\text{C}$
	Rectifier	Brake Diode		
$V_{0\ max}$	threshold voltage	0.81	1.31	V
$R_{0\ max}$	slope resistance *	3.2	8	mΩ

Outlines V2-Pack

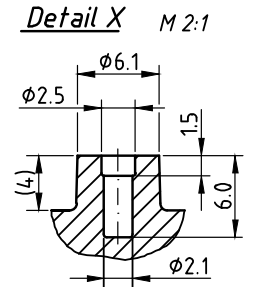
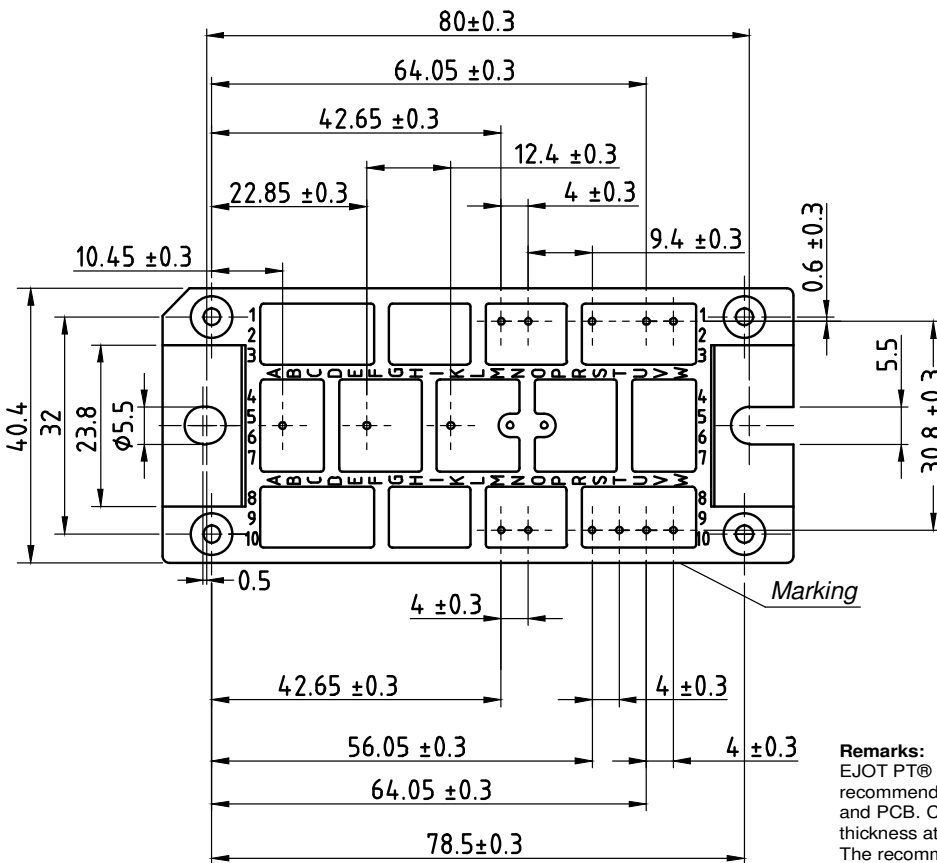
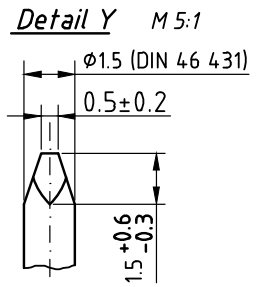
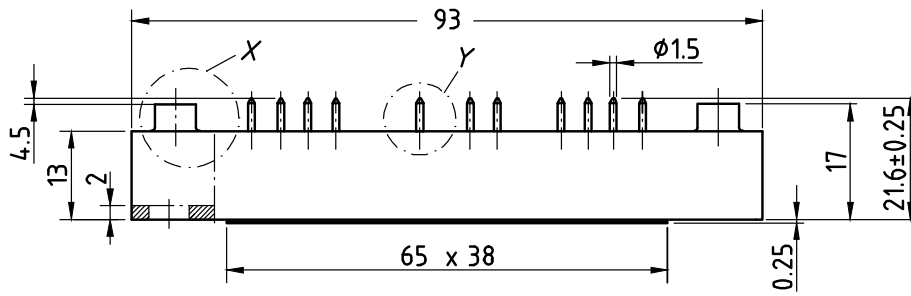

Remarks:
 EJOT PT® self-tapping screws of the dimension K25 are recommended for the mechanical connection between module and PCB. Choose the right length according to your board thickness at a maximum depth of 6 mm of the module holes. The recommended mounting torque is 1.5 Nm.

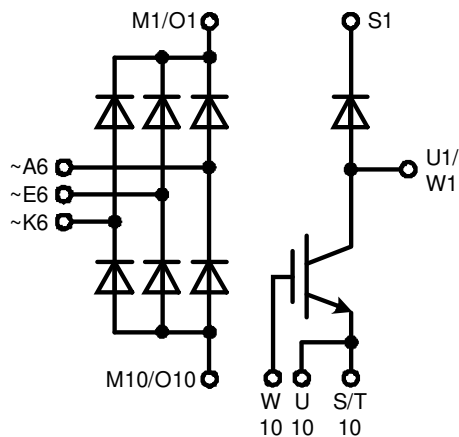

Rectifier

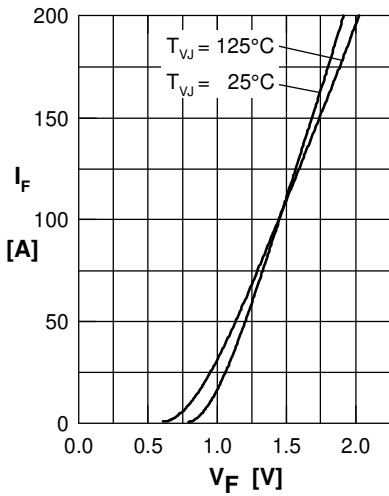

Fig. 1 Forward current vs. voltage drop per diode

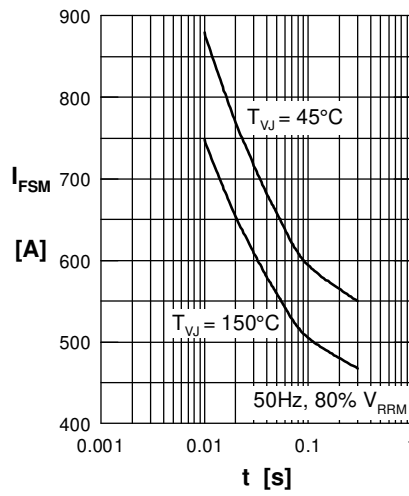

Fig. 2 Surge overload current vs. time per diode

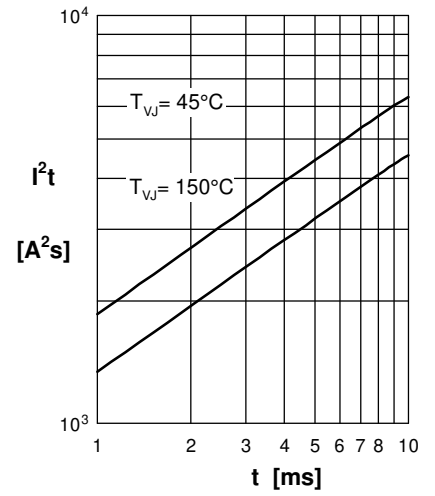

Fig. 3 I^2t vs. time per diode

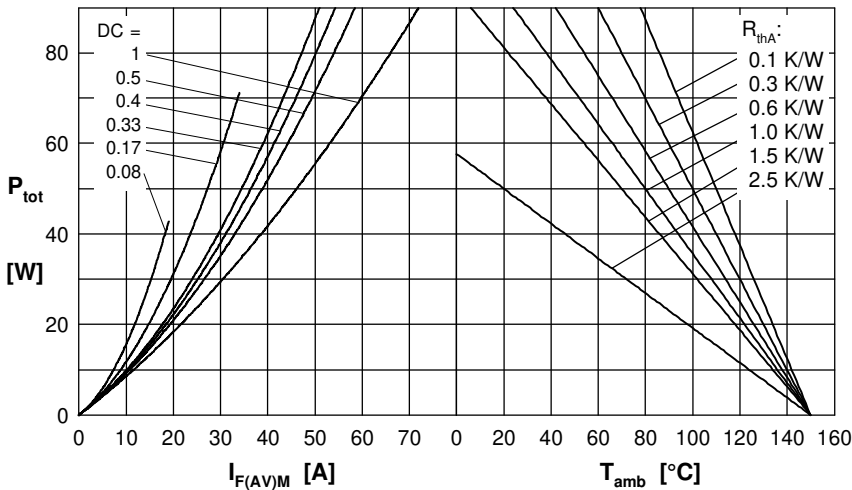

Fig. 4 Power dissipation vs. forward current and ambient temperature per diode

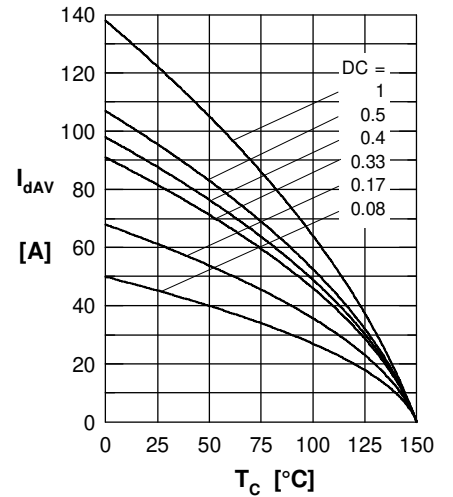

Fig. 5 Max. forward current vs. case temperature per diode

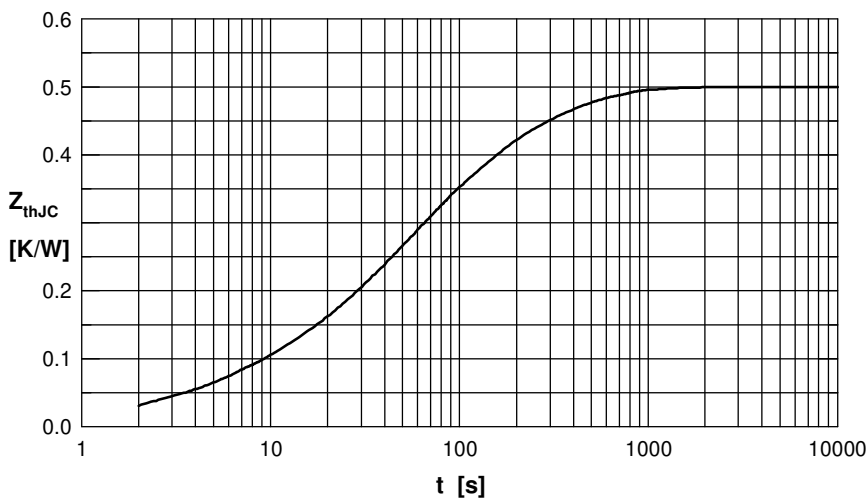

Fig. 6 Transient thermal impedance junction to case vs. time per diode

Constants for Z_{thJC} calculation:

i	R_{th} (K/W)	t_i (s)
1	0.040	0.004
2	0.003	0.010
3	0.140	0.030
4	0.120	0.300
5	0.197	0.080

Brake IGBT + Diode

Fig.1 Output characteristics IGBT



Fig.2 Typ. output characteristics IGBT

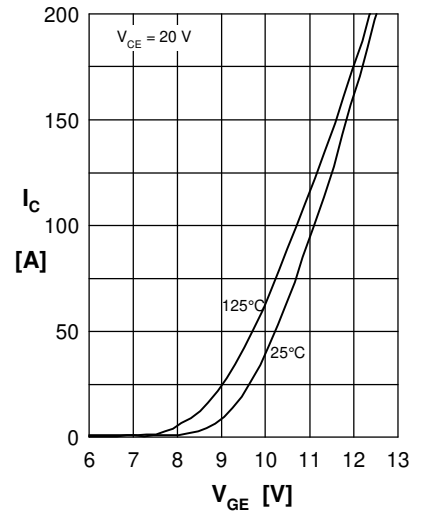

Fig.3 Typ. transfer charact. IGBT



Fig.4 Typ. turn-on energy & switch. times vs. collector current



Fig.5 Typ. turn-off energy & switch. times vs. collector current

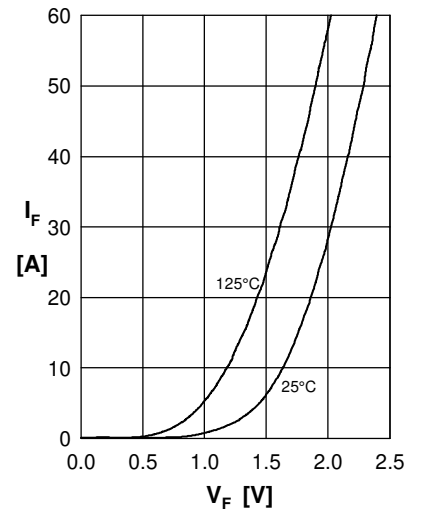

Fig.6 Typ. forward characteristics Diode

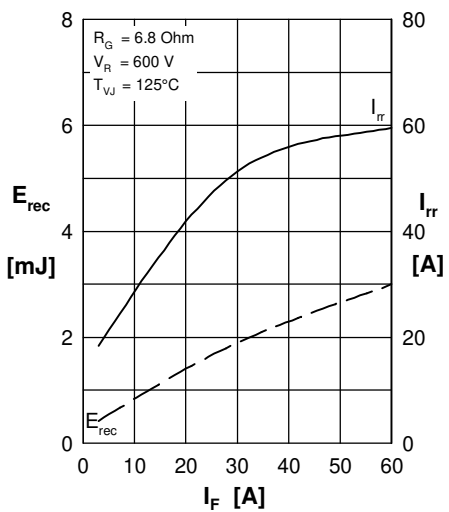

Fig.7 Typ. reverse recovery characteristics Diode

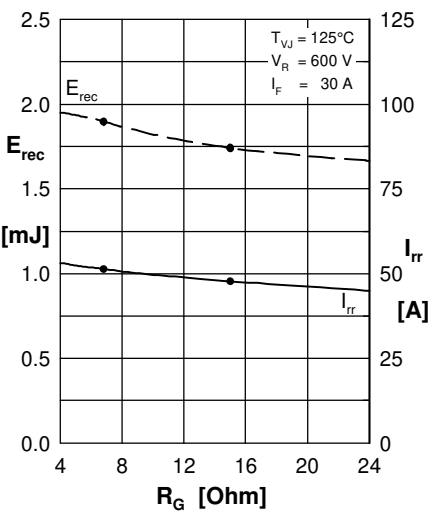

Fig.8 Typ. reverse recovery characteristics Diode

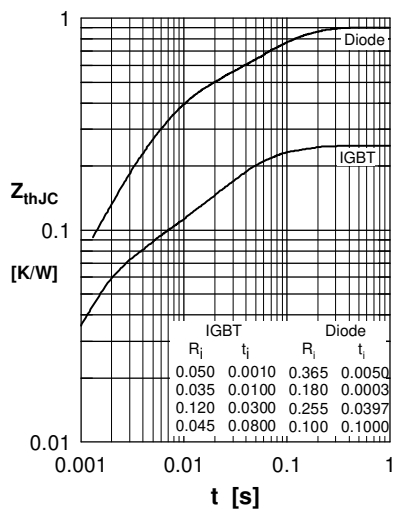

Fig.9 Transient thermal resistance junction to case