

### MG06400D-BN1MM Series 400A Dual IGBT

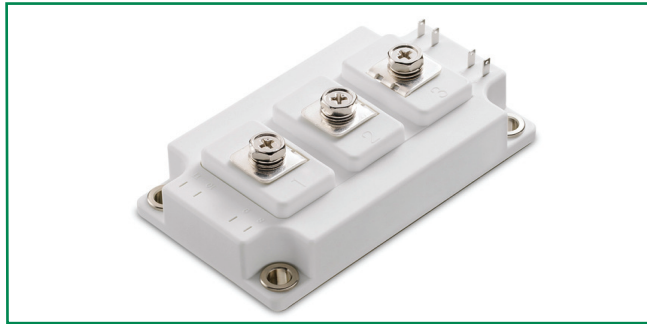

#### Features

- Ultra low loss
- High ruggedness
- High short circuit capability
- Positive temperature coefficient

#### Applications

- Motor drives
- Inverter
- Converter
- SMPS and UPS
- Welder
- Induction Heating

#### Agency Approvals

AGENCY	AGENCY FILE NUMBER
	E71639

#### Module Characteristics ( $T_c = 25^\circ\text{C}$ , unless otherwise specified)

Symbol	Parameters	Test Conditions	Min	Typ	Max	Unit
$T_{vj(max)}$	Max. Junction Temperature				150	$^\circ\text{C}$
$T_{vj op}$	Operating Temperature		-40		150	$^\circ\text{C}$
$T_{STG}$	Storage Temperature Range		-40		125	$^\circ\text{C}$
$V_{isol}$	Insulation Test Voltage	AC, t=1min		3000		V
CTI	Comparative Tracking Index	Module case exposed to 0.1% ammonium chloride solution per UL and IEC standards	350			V
$R_{thJC}$	Junction-to-Case Thermal Resistance	Per IGBT			0.09	K/W
$R_{thJD}$	Junction-to-Case Thermal Resistance	Per Inverse Diode			0.15	K/W
Torque	Module-to-Sink	Recommended (M6)	3		5	N-m
Torque	Module Electrodes	Recommended (M6)	2.5		5	N-m
Weight				310		g

#### Absolute Maximum Ratings ( $T_c = 25^\circ\text{C}$ , unless otherwise specified)

Symbol	Parameters	Test Conditions	Values	Unit
<b>IGBT</b>				
$V_{CES}$	Collector - Emitter Voltage		600	V
$V_{GES}$	Gate - Emitter Voltage		$\pm 20$	V
$I_c$	DC Collector Current	$T_c=25^\circ\text{C}$	460	A
		$T_c=50^\circ\text{C}$	400	A
$I_{cpuls}$	Pulsed Collector Current	$T_c=25^\circ\text{C}, t_p=1\text{ms}$	920	A
		$T_c=50^\circ\text{C}, t_p=1\text{ms}$	800	A
$P_{tot}$	Power Dissipation Per IGBT		1400	W

#### Free-Wheeling Diode

$V_{RRM}$	Repetitive Reverse Voltage		600	V
$I_{F(AV)}$	Average Forward Current	$T_c=25^\circ\text{C}$	400	A
		$T_c=50^\circ\text{C}$	320	A
$I_{F(RMS)}$	RMS Forward Current		570	A
$I_{FSM}$	Non-Repetitive Surge Forward Current	$T_{vj}=45^\circ\text{C}, t=10\text{ms}, \text{Sine}$	1200	A
		$T_{vj}=45^\circ\text{C}, t=8.3\text{ms}, \text{Sine}$	1320	A

Life Support Note:

#### Not Intended for Use in Life Support or Life Saving Applications

The products shown herein are not designed for use in life sustaining or life saving applications unless otherwise expressly indicated.

### Electrical Characteristics ( $T_c = 25^\circ\text{C}$ , unless otherwise specified)

Symbol	Parameters	Test Conditions	Min	Typ	Max	Unit
<b>IGBT</b>						
$V_{GE(th)}$	Gate - Emitter Threshold Voltage	$V_{CE}=V_{GE}, I_C=8\text{mA}$	4.5	5.5	6.5	V
$V_{CE(sat)}$	Collector - Emitter Saturation Voltage	$I_C=400\text{A}, V_{GE}=15\text{V}, T_{Vj}=25^\circ\text{C}$		1.95	2.45	V
		$I_C=400\text{A}, V_{GE}=15\text{V}, T_{Vj}=125^\circ\text{C}$		2.2		V
$I_{CES}$	Collector Leakage Current	$V_{CE}=600\text{V}, V_{GE}=0\text{V}, T_{Vj}=25^\circ\text{C}$			1	mA
		$V_{CE}=600\text{V}, V_{GE}=0\text{V}, T_{Vj}=125^\circ\text{C}$		2		mA
$I_{GES}$	Gate Leakage Current	$V_{CE}=0\text{V}, V_{GE}=\pm 20\text{V}$	1.2		1.2	$\mu\text{A}$
$R_{Gint}$	Intergrated Gate Resistor			2.5		$\Omega$
$Q_{ge}$	Gate Charge	$V_{CE}=300\text{V}, I_C=400\text{A}, V_{GE}=\pm 15\text{V}$		1.8		$\mu\text{C}$
$C_{ies}$	Input Capacitance	$V_{CE}=25\text{V}, V_{GE}=0\text{V}, f=1\text{MHz}$		18		nF
$C_{oes}$	Output Capacitance			1.8		nF
$C_{res}$	Reverse Transfer Capacitance			1.6		nF
$t_{d(on)}$	Turn - on Delay Time	$V_{CC}=300\text{V}$ $I_C=400\text{A}$ $R_G=3\Omega$ $V_{GE}=\pm 15\text{V}$ Inductive Load	$T_{Vj}=25^\circ\text{C}$		195	ns
			$T_{Vj}=125^\circ\text{C}$		220	ns
$t_r$	Rise Time		$T_{Vj}=25^\circ\text{C}$		65	ns
			$T_{Vj}=125^\circ\text{C}$		80	ns
$t_{d(off)}$	Turn - off Delay Time		$T_{Vj}=25^\circ\text{C}$		295	ns
			$T_{Vj}=125^\circ\text{C}$		350	ns
$t_f$	Fall Time		$T_{Vj}=25^\circ\text{C}$		45	ns
			$T_{Vj}=125^\circ\text{C}$		60	ns
$E_{on}$	Turn - on Energy		$T_{Vj}=25^\circ\text{C}$		6.5	mJ
			$T_{Vj}=125^\circ\text{C}$		10	mJ
$E_{off}$	Turn - off Energy	$T_{Vj}=25^\circ\text{C}$		9.5	mJ	
		$T_{Vj}=125^\circ\text{C}$		14.5	mJ	
<b>Free-Wheeling Diode</b>						
$V_F$	Forward Voltage	$I_F=400\text{A}, V_{GE}=0\text{V}, T_{Vj}=125^\circ\text{C}$		1.25	1.6	V
		$I_F=400\text{A}, V_{GE}=0\text{V}, T_{Vj}=125^\circ\text{C}$		1.2		V
$T_{rr}$	Reverse Recovery Time	$I_F=400\text{A}, V_R=300\text{V}$		249		ns
$I_{RRM}$	Reverse Recovery Charge	$d_f/dt=-2000\text{A}/\mu\text{s}$		214		A
$Q_{rr}$	Reverse Recovery Charge	$T_J=125^\circ\text{C}$		31		$\mu\text{C}$

**Figure 1: Typical Output Characteristics**

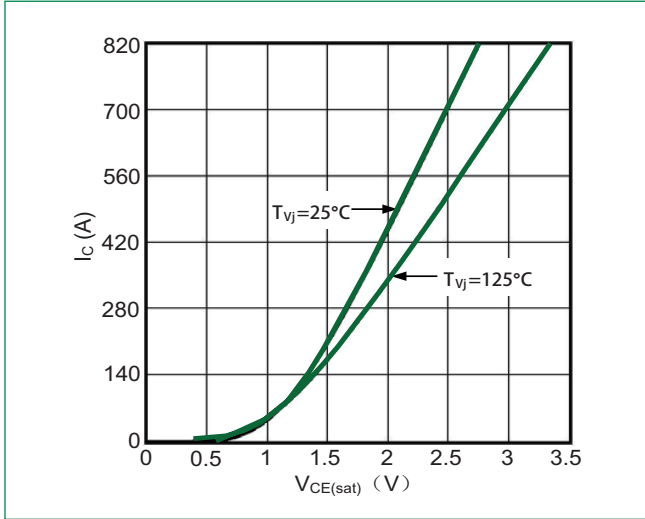

**Figure 2: Typical Transfer Characteristics**

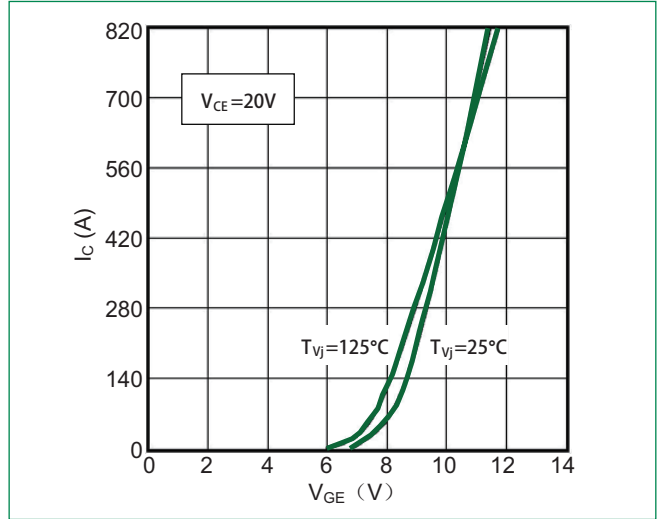

**Figure 3: Switching Energy vs. Collector Current**

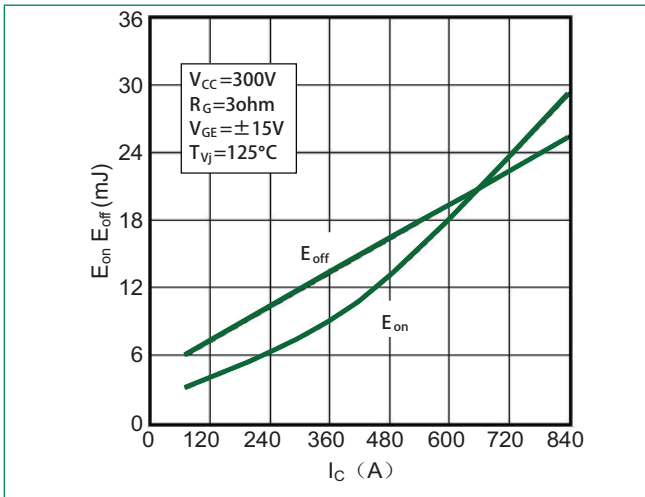

**Figure 4: Switching Energy vs. Gate Resistor**

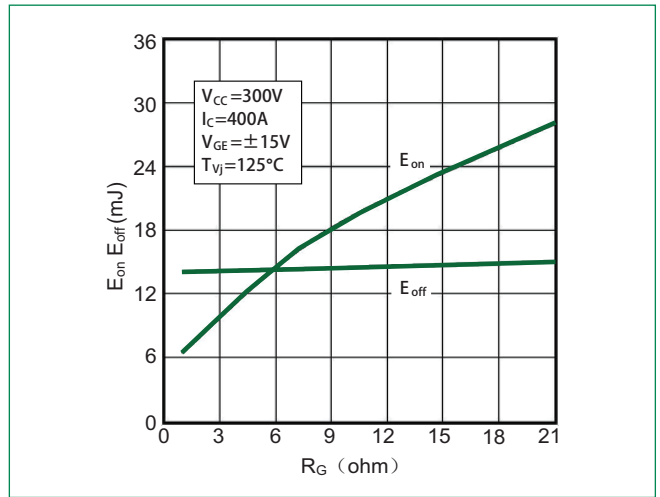

**Figure 5: Switching Times vs. Collector Current**

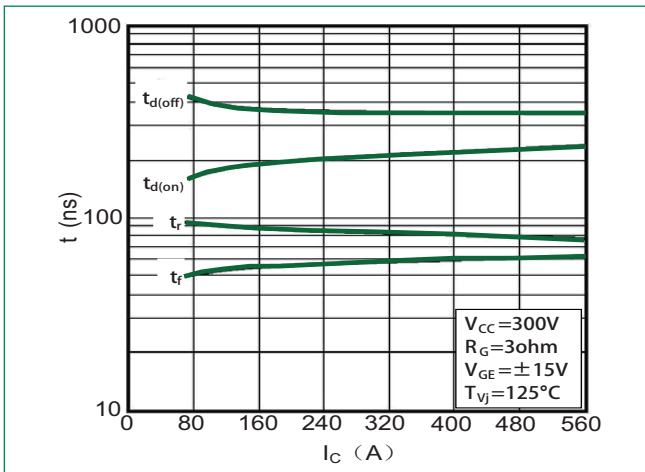

**Figure 6: Switching Times vs. Gate Resistor**

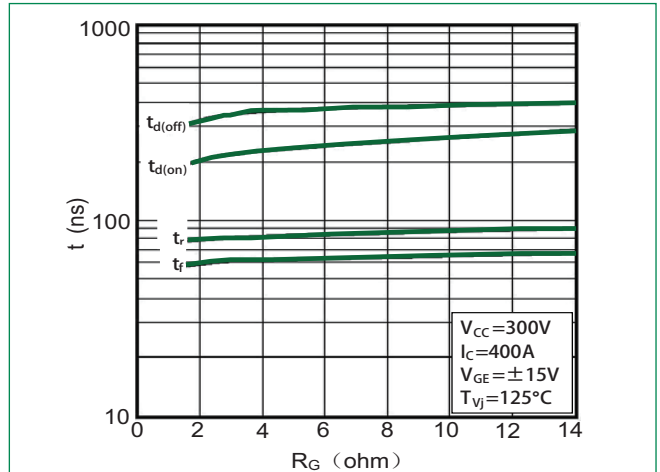

**Figure 7: Diode Forward Characteristics**

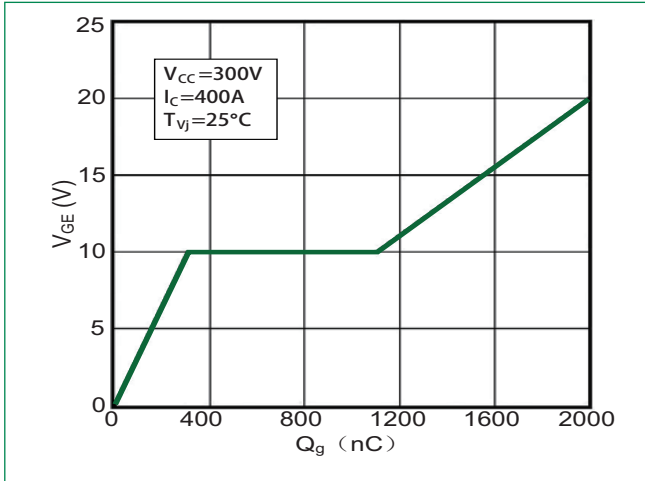

**Figure 8: Typical Capacitances vs. V\_CE**

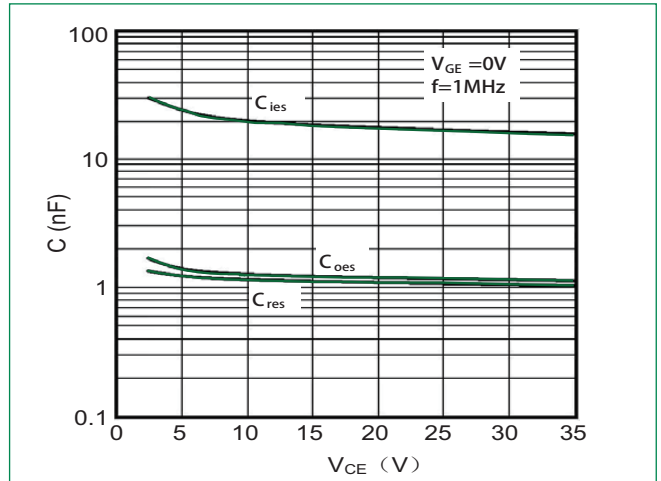

**Figure 9: Reverse Biased Safe Operating Area**

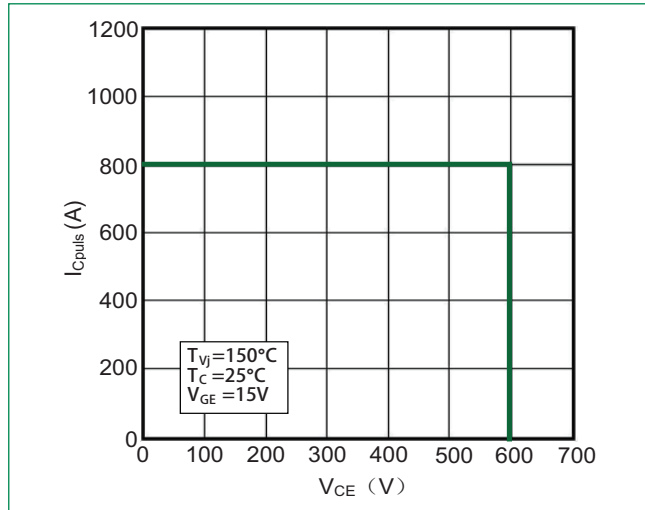

**Figure 10: Short Circuit Safe Operating Area**

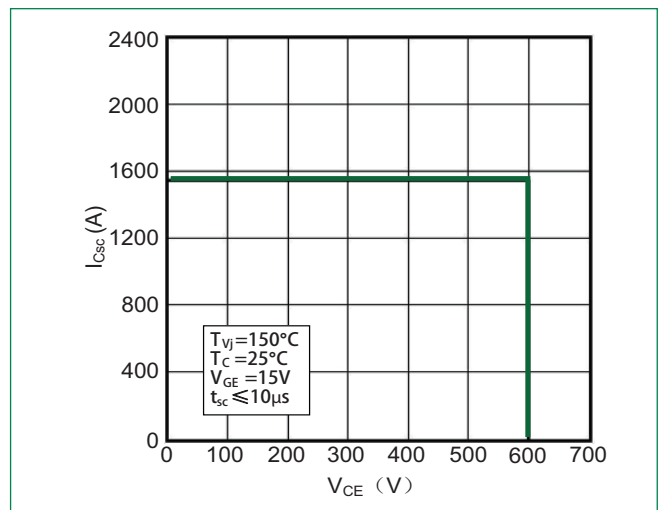

**Figure 11: Rated Current vs. T\_C**

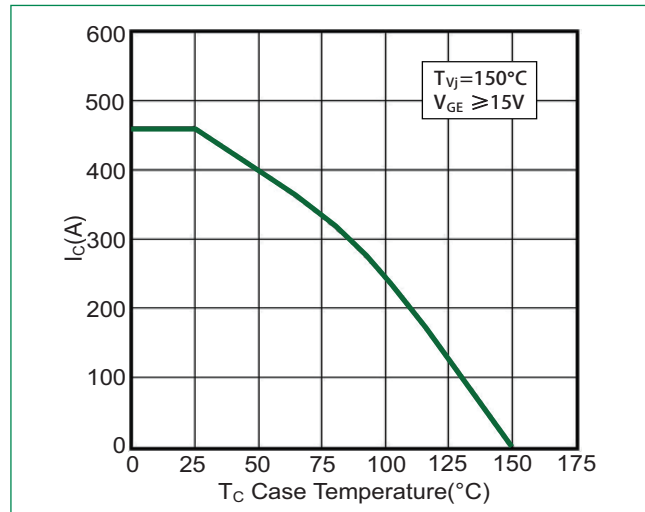

**Figure 12: Diode Forward Characteristics**

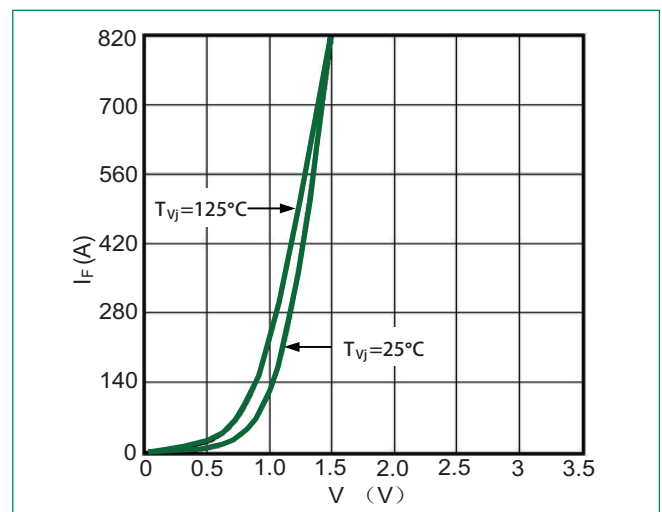

**Figure 13: Transient Thermal Impedance of IGBT**

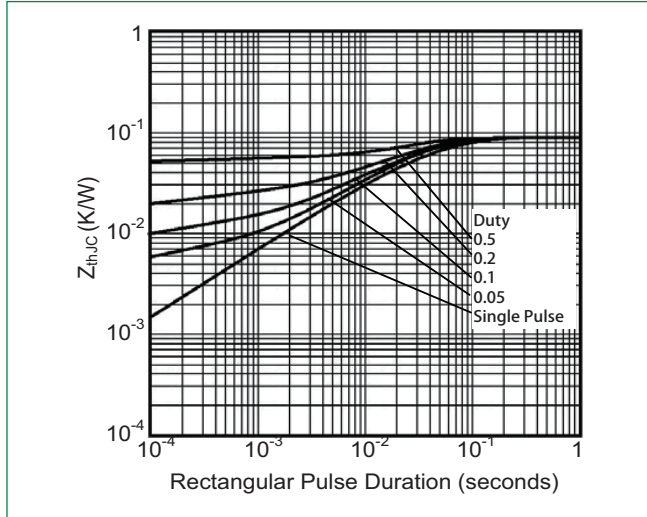

**Figure 14: Transient Thermal Impedance of Diode**

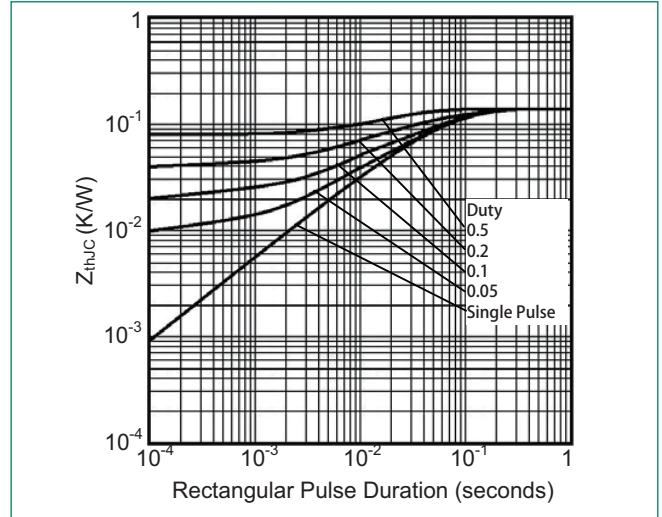

**Dimensions-Package D**

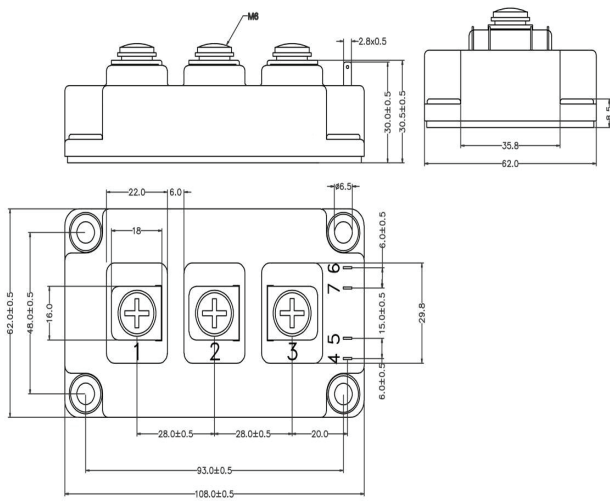

**Circuit Diagram and Pin Assignment**

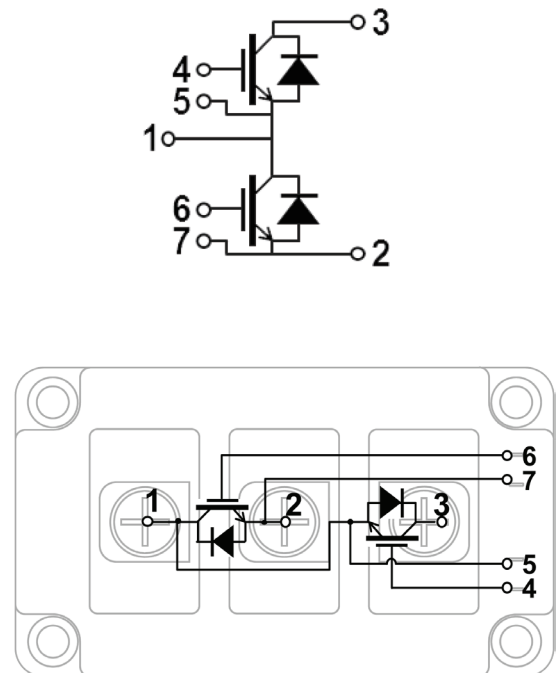

**Packing Options**

Part Number	Marking	Weight	Packing Mode	M.O.Q
MG06400D-BN1MM	MG06400D-BN1MM	310g	Bulk Pack	30

**Part Numbering System**

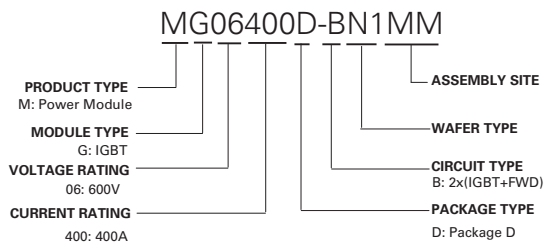

**Part Marking System**

