

RTD Converter KFD0-TR-1

- 1-channel signal conditioner
- 24 V DC supply (loop powered)
- 2- or 3-wire Pt100 RTD input
- Output 4 mA ... 20 mA, temperature linearization selectable
- DIP switch selectable ranges
- Sensor breakage detection



Function

This isolated signal conditioner is a loop-powered isolator that converts the resistance from a 3-wire RTD to a 4 mA ... 20mA signal and provides isolation for non-intrinsically safe applications. A selectable analog linearization ensures a temperature linear 4 mA ... 20mA output between 25 °C ... 375 °C. It also features conveniently located DIP switches and potentiometers to make field calibration easy.

Connection

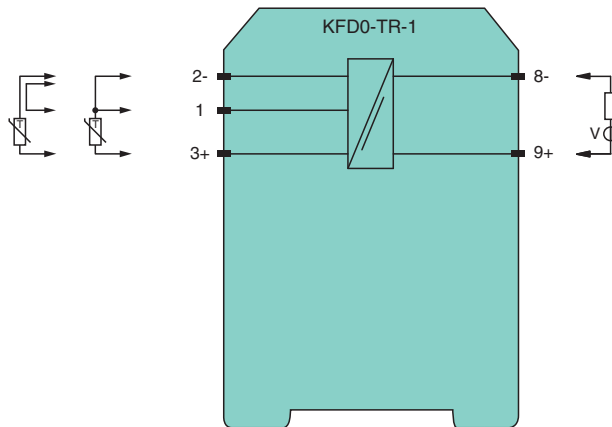

Technical Data

General specifications

Signal type	Analog input		
Supply			
Rated voltage	U_r	12 ... 35 V DC loop powered	
Power dissipation		0.4 W	
Input			
Connection side		field side	
Connection		terminals 1, 2-, 3+ suitable for Pt100, 2- and 3-wire connection	
Lead resistance		max. 100 Ω per line	
Measuring current		approx. 1 mA	
Output			

Release date: 2021-12-10 Date of issue: 2021-12-10 Filename: 038307_eng.pdf

Refer to "General Notes Relating to Pepperl+Fuchs Product Information".

Pepperl+Fuchs Group
www.pepperl-fuchs.com

USA: +1 330 486 0002
pa-info@us.pepperl-fuchs.com

Germany: +49 621 776 2222
pa-info@de.pepperl-fuchs.com

Singapore: +65 6779 9091
pa-info@sg.pepperl-fuchs.com

PF PEPPERL+FUCHS

Technical Data

Connection side		control side
Connection		terminals 9+, 8-
Load		(U -12 V) / 0.02 A
Current output		4 ... 20 mA , limited to ≤ 35 mA
Fault signal		sensor burnout: upscaling ≥ 22 mA , limited to ≤ 35 mA
Transfer characteristics		
Measurement range	f_n	span without linearization 25 ... 800 °C (77 ... 1472 °F)/ with linearisation 25 ... 375 °C (77 ... 707 °F) zero point without linearization -200 ... 400 °C (-328 ... 752 °F)/ with linearisation -30 ... 375 °C (-22 ... 707 °F) span and zero point adjustable
Deviation		
After calibration		0.1 % of full-scale value
Influence of ambient temperature		span and zero point 0.015 % / K or ± 10 mΩ / K
Influence of supply voltage		6.5 ppm/V
Rise time		250 ms
Galvanic isolation		
Input/Output		safe isolation acc. to DIN VDE 0106, rated insulation voltage 253 V _{eff}
Indicators/settings		
Control elements		DIP switch rotary switch
Configuration		via DIP switches via rotary switch
Labeling		space for labeling at the front
Directive conformity		
Electromagnetic compatibility		
Directive 2014/30/EU		EN 61326-1:2013 (industrial locations)
Conformity		
Insulation coordination		EN 50178
Galvanic isolation		EN 50178
Degree of protection		IEC 60529
Ambient conditions		
Ambient temperature		-20 ... 60 °C (-4 ... 140 °F) extended ambient temperature range up to 70 °C (158 °F), refer to manual for necessary mounting conditions
Mechanical specifications		
Degree of protection		IP20
Connection		screw terminals
Mass		approx. 150 g
Dimensions		20 x 119 x 115 mm (0.8 x 4.7 x 4.5 inch) (W x H x D) , housing type B2
Mounting		on 35 mm DIN mounting rail acc. to EN 60715:2001
General information		
Supplementary information		Observe the certificates, declarations of conformity, instruction manuals, and manuals where applicable. For information see www.pepperl-fuchs.com .

Assembly

Front view

Removable terminal green

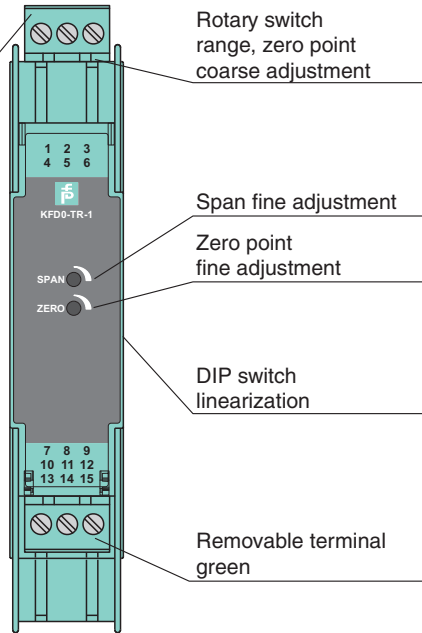

Rotary switch
range, zero point
coarse adjustment

Span fine adjustment

Zero point
fine adjustment



DIP switch
linearization

Removable terminal
green

Matching System Components

	K-DUCT-GY	Profile rail, wiring comb field side, gray
---	------------------	--

Accessories

	KF-ST-5GN	Terminal block for KF modules, 3-pin screw terminal, green
	KF-CP	Red coding pins, packaging unit: 20 x 6

Release date: 2021-12-10 Date of issue: 2021-12-10 Filename: 038307_eng.pdf

Refer to "General Notes Relating to Pepperl+Fuchs Product Information".

Pepperl+Fuchs Group
www.pepperl-fuchs.com

USA: +1 330 486 0002
pa-info@us.pepperl-fuchs.com

Germany: +49 621 776 2222
pa-info@de.pepperl-fuchs.com

Singapore: +65 6779 9091
pa-info@sg.pepperl-fuchs.com

Configuration

DIP switches function

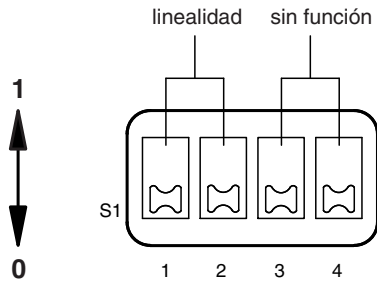

Switch	Position	Function
S1.1	1	Pt100 with linearisation (-30 °C ... 375 °C)
S1.2	0	
S1.1	0	Pt100 without linearisation (-200 °C ... 800 °C)
S1.2	1	

Other combinations of S1.1 and S1.2 are not allowed.

Rotary switches function

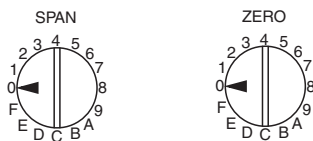

Please consider that both tables contain typical values, which can be used as an adjustment help.

Adjustment range with linearisation					
Switch SPAN (°C) coarse adjustment	D	6	2	1	0
	20 ... 60	35 ... 100	75 ... 220	120 ... 340	260 ... 375
Switch ZERO (°C) coarse adjustment					
0	-	-	-	-	-
1	-	-	-	-	-
2	-	-	-	-	-
3	-	-	-	-	-
4	-	-	-	-	-
5	-19 ... 50	-22 ... 45	-30 ... 29	-30 ... 13	-
6	35 ... 103	30 ... 97	16 ... 78	2 ... 61	-30 ... 0
7	87 ... 155	82 ... 148	65 ... 127	48 ... 107	-10 ... 38
8	142 ... 207	134 ... 200	115 ... 177	96 ... 154	28 ... 76
9	192 ... 257	185 ... 249	162 ... 223	141 ... 198	65 ... 111
A	245 ... 306	234 ... 297	209 ... 269	185 ... 242	-
B	290 ... 355	282 ... 344	254 ... 315	-	-
C	338 ... 375	329 ... 375	-	-	-
D	-	-	-	-	-
E	-	-	-	-	-
F	-	-	-	-	-

Adjustment range without linearisation					
Switch SPAN (°C) coarse adjustment	D	6	2	1	0
	25 ... 60	40 ... 100	90 ... 230	140 ... 360	320 ... 800
Switch ZERO (°C) coarse adjustment					
0	-	-	-	-	-
1	-200 ... -171	-200 ... -172	-200 ... -176	-200 ... -179	-
2	-183 ... -112	-184 ... -115	-188 ... -122	-191 ... -129	-200 ... -153
3	-126 ... -54	-127 ... -54	-134 ... -67	-140 ... -77	-163 ... -111
4	-68 ... -6	-71 ... 1	-80 ... -12	-90 ... -24	-122 ... -70
5	-9 ... 65	-14 ... 59	-26 ... 42	-38 ... 27	-80 ... -29
6	48 ... 123	43 ... 116	28 ... 97	14 ... 78	-40 ... 12
7	107 ... 182	101 ... 175	82 ... 151	65 ... 130	1 ... 53
8	168 ... 243	160 ... 234	138 ... 208	117 ... 183	43 ... 95
9	226 ... 302	217 ... 292	192 ... 262	168 ... 234	82 ... 135
A	284 ... 361	274 ... 350	246 ... 317	219 ... 285	122 ... 174
B	343 ... 400	331 ... 400	300 ... 372	270 ... 337	162 ... 215
C	-	-	353 ... 400	320 ... 388	201 ... 254
D	-	-	-	37 ... 400	241 ... 293
E	-	-	-	-	279 ... 333
F	-	-	-	-	318 ... 372

Release date: 2021-12-10 Date of issue: 2021-12-10 Filename: 038307_eng.pdf

Recommendation for adjustment:

1. Span determination.
2. "Span coarse adjustment" in accordance with the table (for mode of operation "without linearisation" considering the approx. measurement range start).
3. Minimum value adjustment (in °C) at the input.
4. "Zero point coarse adjustment" to approach to 4 mA.
5. "Zero point fine adjustment" to exactly 4 mA.
6. Maximum value adjustment (in °C) at the input.
7. "Span fine adjustment" to exactly 20 mA.
8. If necessary repeat fine adjustment for 4 mA and 20 mA