

GHB-3M60-Y GHB-3M45-R GHB-3M60-R

Description

This family of 3 mm LED Lamps is capable of withstanding automatic insertion and wave soldering processes.

Designed with a thick epoxy flange and soft leadframe material, it is ideal for clinch and cut operations.

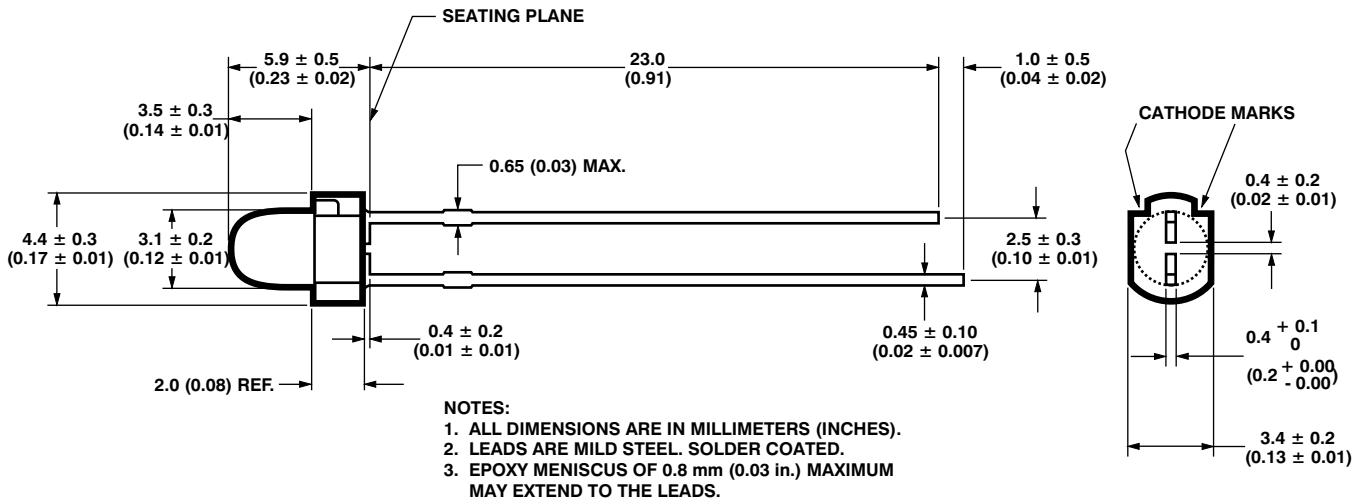

Device Selection Guide

High Brightness Lamps		Package		Luminous Intensity, Min. Iv @ 20 mA	Viewing Angle, 2 1/2
Color	Part Number	Tinted	Diffused		
Red	GHB-3M45-R	μ		90.2	45
	GHB-3M60-R	μ		90.2	60
Amber	GHB-3M60-Y	μ		96.2	60

Note:

1. 2 1/2 is the off axis angle where the luminous intensity is 1/2 the on axis intensity.

Absolute Maximum Ratings at T_A = 25 1/4C

Parameter	Yellow	A1InGaP Amber & Red	Units
DC Forward Current ^[1]	20	30 ^[2,3]	mA
Reverse Voltage (I _r = 100 A)	5		V
Junction Temperature, T _{jmax}	110		C
Storage Temperature Range	-40 to +85		C
Operating Temperature Range	-20 to +85	-40 to +85	C
Lead Soldering Temperature [1.6 mm (0.063 in.) from seating plane]	A) DIP/DRAG Soldering: 260 C for 5 seconds B) Wave Solder Temperature: 245 C for 3 seconds		

Notes:

- See Page 3 for maximum current derating vs. ambient temperature.
- Suggested minimum DC current: 10 mA
- Maximum Peak Pulsed Forward Current: 50 mA, 30 mA average.

Electrical Characteristics at T_A = 25 1/4C

Part Number	Forward Voltage V _f (Volts)			Capacitance C (pF) V _f = 0, f = 1 MHz Typ.	Thermal Resistance R _{J-PIN} (C/W)	Speed of Response s (ns) Time Constant e ^{-t/ s} Typ.
	Typ.	Max.	I _f (mA)			
GHB-3M60-Y	2.02	2.4	20	40	240	20
GHB-3M45/60-R	1.90	2.4	20	40	240	20

Optical Characteristics at T_A = 25 1/4C

Part Number	Luminous Intensity		Typ. Peak Wavelength (nm)	Typ. Dominant Wavelength (nm)	Typ. Spectral Half Width	Luminous Efficacy Width (lm/W)
	Min.	I _f (mA)				
GHB-3M45-R	90.2	20	635	626	17	150
GHB-3M60-R	90.2	20	635	626	17	150
GHB-3M60-Y	96.2	20	592	590	17	480

HIGH BRIGHTNESS LAMPS

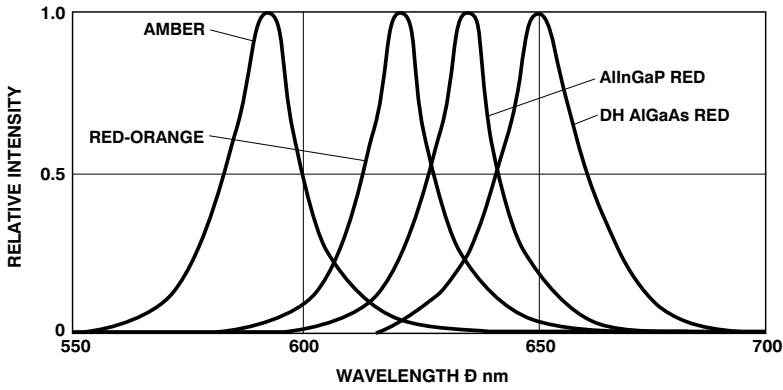

HIGH BRIGHTNESS LAMPS

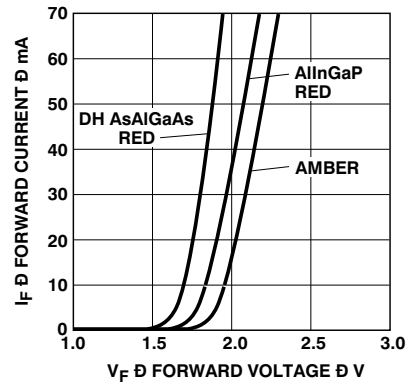

HIGH BRIGHTNESS LAMPS

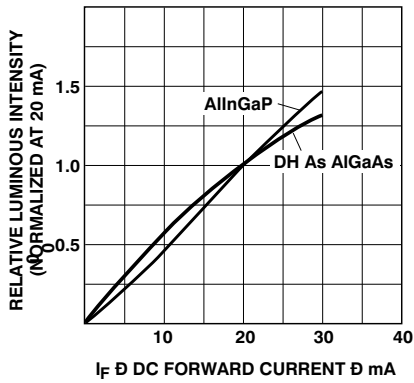

AllnGaP

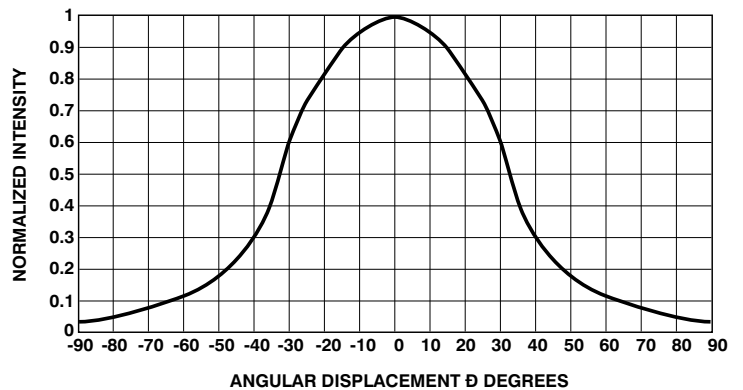
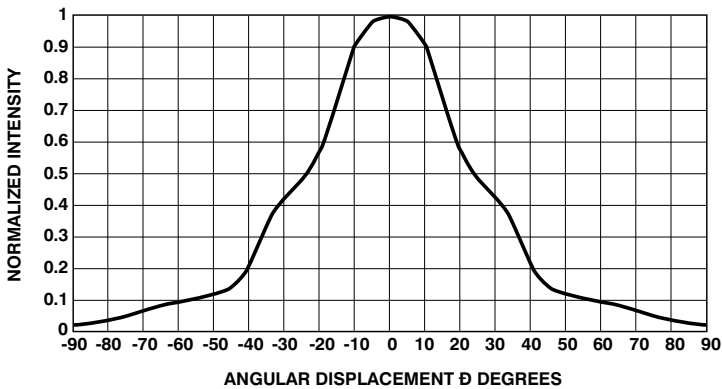
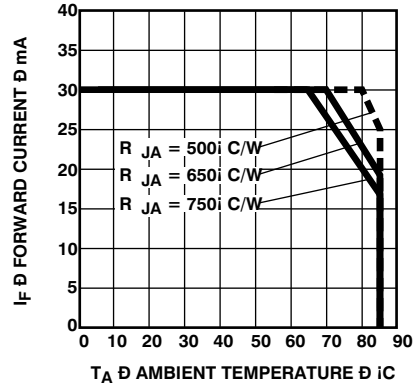

Representative Spatial Radiation Pattern for 45 Viewing Angle.

Representative Spatial Radiation Pattern for 60 Viewing Angle.