

PLEASE CHECK WWW.MOLEX.COM FOR LATEST PART INFORMATION

Part Number: **0945294108**
Status: **Active**
Description: 5.00mm (.197") Pitch RAST, Receptacle, Natural Color, PA Polyamide (Nylon) 6/6, 8 Circuits, Glow Wire Compatible

Documents:

[Drawing \(PDF\)](#) [Product Specification PS-94529-002 \(PDF\)](#)
[Product Specification PS-94529-001 \(PDF\)](#) [RoHS Certificate of Compliance \(PDF\)](#)

Agency Certification

CSA LR19980
 UL E29179

General

Product Family Crimp Housings
 Series [94529](#)
 Product Name Pitch 5 Edge Card

Physical

Breakaway No
 Circuits (maximum) 8
 Color - Resin Natural
 Flammability 94V-0
 Gender Female
 Glow-Wire Compliant Yes
 Lock to Mating Part Yes
 Material - Resin Nylon
 Number of Rows 1
 Packaging Type Bag
 Panel Mount No
 Pitch - Mating Interface (in) 0.197 In
 Pitch - Mating Interface (mm) 5.00 mm
 Pitch - Term. Interface (in) 0.197 In
 Pitch - Term. Interface (mm) 5.00 mm
 Polarized to Mating Part Yes
 Ports 1
 Stackable No
 Temperature Range - Operating -40°C to +105°C, -40°C to +85°C

Electrical

Current - Maximum per Contact 6A

Material Info

Reference - Drawing Numbers

Product Specification PS-94529-001, PS-94529-002
 Sales Drawing SD-94529-010

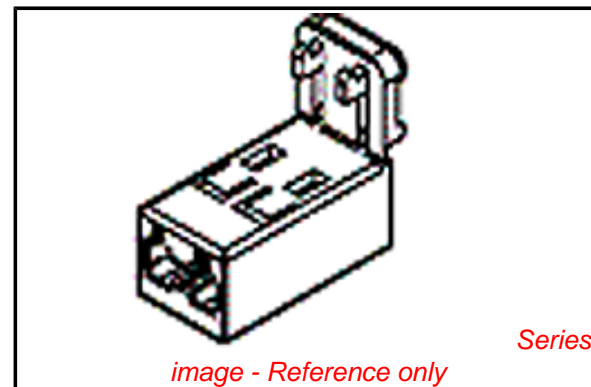

EU RoHS

**ELV and RoHS
 Compliant**
**REACH SVHC
 Not Reviewed**
**Halogen-Free
 Status
 Not Reviewed**

China RoHS



**Need more information on product
 environmental compliance?**

Email productcompliance@molex.com
 For a multiple part number RoHS Certificate of Compliance, [click here](#)

Please visit the [Contact Us](#) section for any non-product compliance questions.

Search Parts in this Series

[94529Series](#)

Mates With

PCB thickness 1.50mm (.059")

Use With

[94529-1203 Terminal](#)

10 9 8 7 6 5 4 3 2 1

SECTION A-A

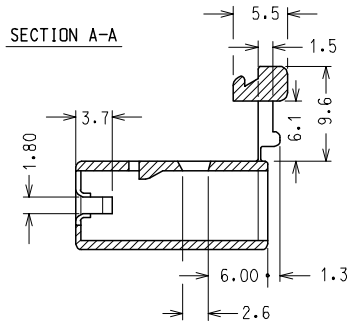

SECTION B-B

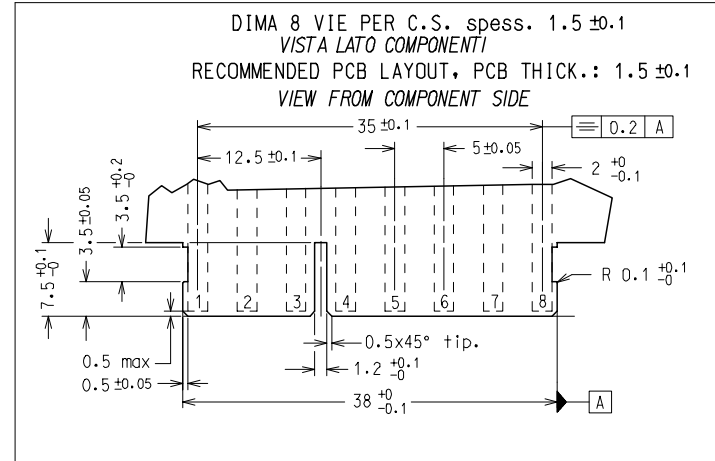
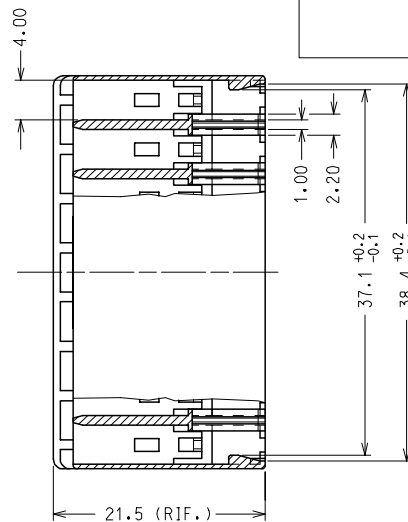
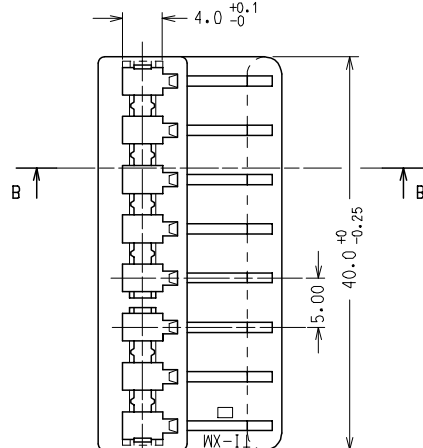
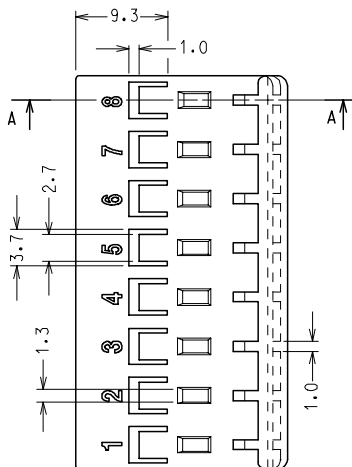
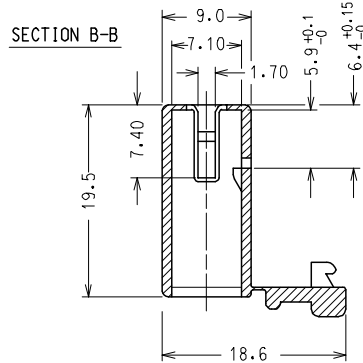

CODICE P/N	COLORE	MATERIALE
94529-9108	NATURALE (NATURAL)	PA 66 UL94 V2 GWT 850°C
94529-9208	NERO (BLACK)	
94529-7108	NATURALE (NATURAL)	PA 66 UL94 VO
94529-4108	NATURALE (NATURAL)	NYLON 6.6 GWT 750 °C sec. IEC 60395-1 TEST METHOD IEC 60695-2-11

NOTA: LE DIMENSIONI VANNO MISURATE CON CORPI STABILIZZATI SECONDO NG 2301. (AUMENTO IN PESO DEL 2.7 %)

NOTE: PARTS SHALL BE DIMENSIONALLY CHECKED AFTER ATTAINING EQUILIBRIUM CONDITIONS E.G. 27 % INCREASE IN WEIGHT FOR HUMIDITY ABSORPTION FROM DRY STATUS.

CARATTERISTICHE PRODOTTO SECONDO PS-94529
PRODUCT CHARACTERISTICS ACCORDING TO PS-94529 E

CONFEZIONE: 3000 pz. in scatola
PACKAGING: 3000 pcs. in carton box

SPQ: 3000 pz.

Descr. Std: HSG FOR FORK TERMINAL 8 CKT

EC NO: Z2006-0051 DRWN: FGOTTARD 2005/10/12 CHKD: RSANDAN 2005/10/12 APPR: GZUIN 2005/10/14	QUALITY SYMBOLS	GENERAL TOLERANCES (UNLESS SPECIFIED)	SCALE 2:1	DESIGN UNITS METRIC	FIRST ANGLE PROJECTION	REVISE ON CAD ONLY	
	DESCRIPTION ▲ -0 ▽ -0	mm INCH	DIMENSION STYLE MM ONLY	TITLE 8 CKT HOUSING FOR STRAIGHT FORK TERMINAL			
		4 PLACES ± --- ± ---	DRAWN BY DATE FGOTTARD 2000/01/25	MOLEX INCORPORATED MATERIAL NO. SEE TABLE SD-94529-010 DOCUMENT NO. SD-94529-010 SHEET NO. 1 OF 1			
		3 PLACES ± --- ± ---	CHECKED BY DATE MTESTAGU 2000/01/25				
2 PLACES ± 0.10 ± ---	APPROVED BY DATE RMARTUCC 2000/01/25	DRAFT WHERE APPLICABLE MUST REMAIN WITHIN DIMENSIONS THIS DRAWING CONTAINS INFORMATION THAT IS PROPRIETARY TO MOLEX INCORPORATED AND SHOULD NOT BE USED WITHOUT WRITTEN PERMISSION					
1 PLACE ± 0.2 ± ---	ANGULAR ± 2 °						