

Product Summary

Symbol	Value	Unit
$I_{T(RMS)}$	8.0	A
$V_{DRM} V_{RRM}$	600 / 800	V
V_{TM}	1.55	V

Feature

With high ability to withstand the shock loading of large current, With high commutation performances, 4 quadrants products especially recommended for use on inductive load.

Application

Washing machine, vacuums, massager, solid state relay, AC Motor speed regulation and so on.

Package



TO-220C

Circuit diagram

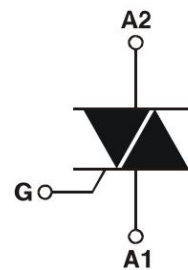

Marking

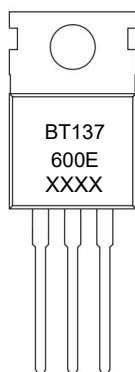

Absolute maximum ratings (Ta=25°C unless otherwise noted)

Parameter	Symbol	Value	Unit	
Repetitive peak off-state voltage	V _{DRM}	600 / 800	V	
Repetitive peak reverse voltage	V _{RRM}	600 / 800	V	
RMS on-state current	I _{T(RMS)}	8	A	
Non repetitive surge peak on-state current (full cycle, F=50Hz)	I _{TSM}	65	A	
I ² t value for fusing (tp=10ms)	I ² t	21	A ² s	
Critical rate of rise of on-state current (I _G = 2 × I _{GT})	di _T /dt	I - II - III	50	A/μs
		IV	10	
Peak gate current	I _{GM}	2	A	
Average gate power dissipation	P _{G(AV)}	0.5	W	
Junction Temperature	T _J	-40 ~ +125	°C	
Storage Temperature	T _{STG}	-40 ~ +150	°C	

Electrical characteristics (T_A=25 °C, unless otherwise noted)

Parameter	Symbol	Test Condition	Value	Unit		
Gate trigger current	I _{GT}	V _D = 12V I _T = 0.1A T _J = 25°C	I - II - III	10	mA	
			IV	25		
Gate trigger voltage	V _{GT}	I - II - III - IV	MAX.	1.3	V	
Gate non-trigger voltage	V _{GD}	V _D = V _{DRM} T _J = 125°C	MIN.	0.2	V	
latching current	I _L	V _D = 12V I _{GT} = 0.1A T _J = 25°C	I - III - IV	25	mA	
			II	35		
Holding current	I _H	I - II - III - IV	MAX.	20	mA	
Critical-rate of rise of commutation voltage	dV _D /dt	V _D = 2/3V _{DRM} Gate Open T _J = 125°C	MIN.	20	V/μs	
STATIC CHARACTERISTICS						
Forward "on" voltage	V _{TM}	I _{TM} = 10A tp=380μs	MAX.	1.55	V	
Repetitive Peak Off-State Current	I _{DRM}	V _D = V _{DRM} V _R = V _{RRM}	T _J = 25°C	MAX.	5	μA
Repetitive Peak Reverse Current	I _{RRM}		T _J = 125°C	MAX.	1	mA
THERMAL RESISTANCES						
Thermal resistance	R _{th(j-c)}	Junction to case(AC)	TYP.	1.6	°C/W	
	R _{th(j-a)}	Junction to ambient	TYP.	60	°C/W	

Typical Characteristics

FIG.1: Maximum power dissipation versus RMS on-state current (full cycle)

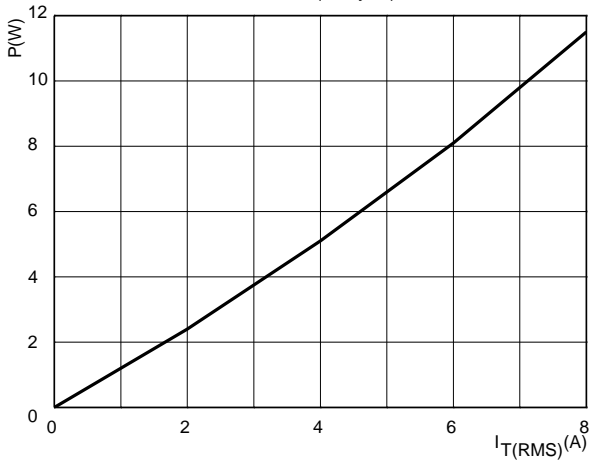

FIG.2: RMS on-state current versus case temperature (full cycle)

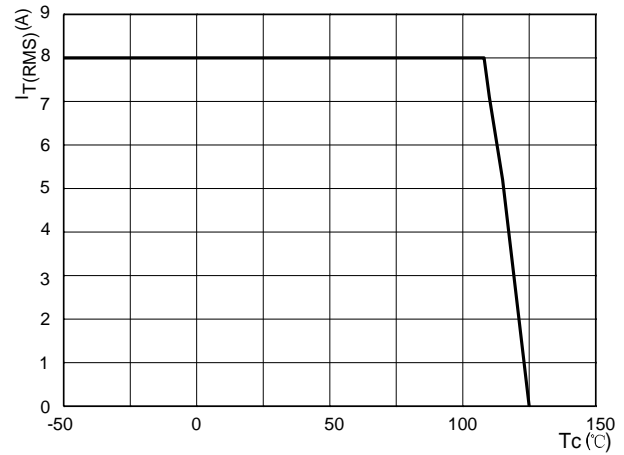

FIG.3: Surge peak on-state current versus number of cycles

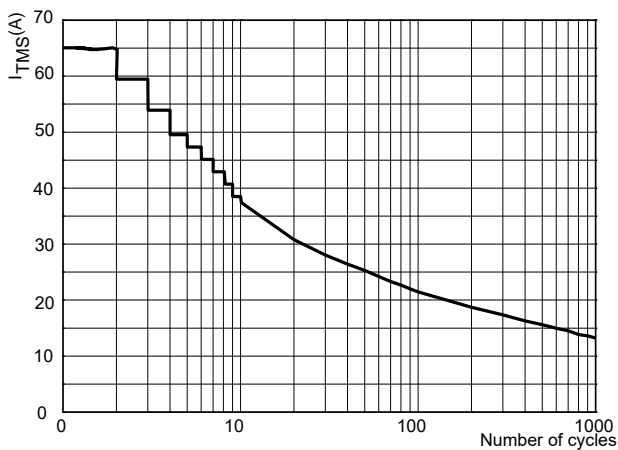

FIG.4: On-state characteristics (maximum values)

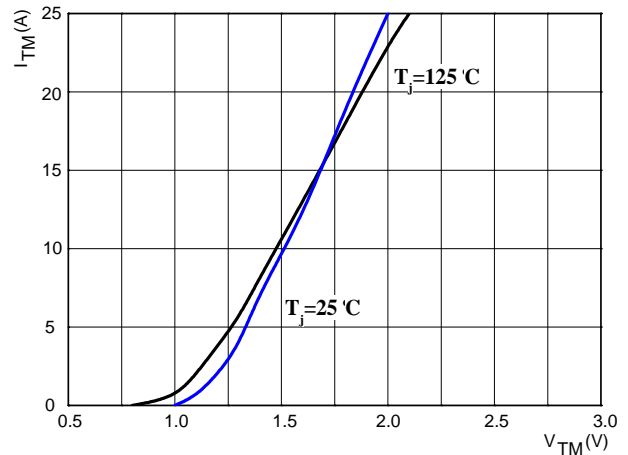

FIG.5: Non-repetitive surge peak on-state current for a sinusoidal pulse with width $t_p < 10\text{ms}$

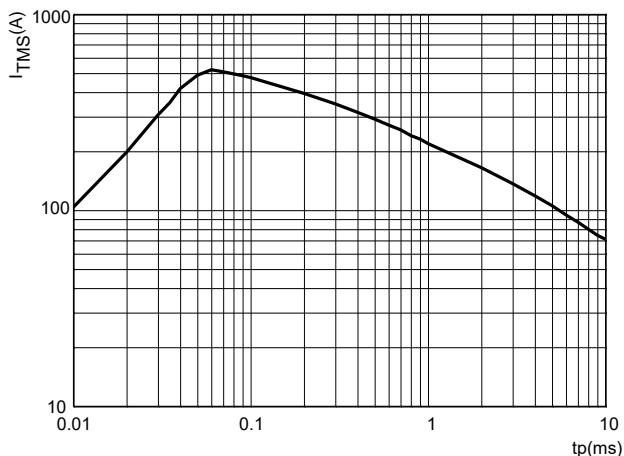
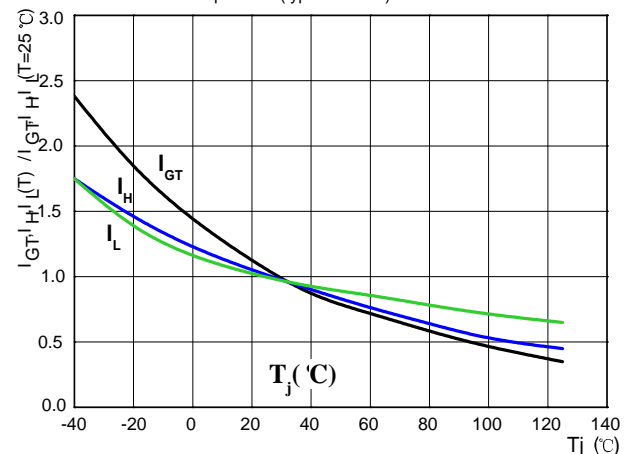
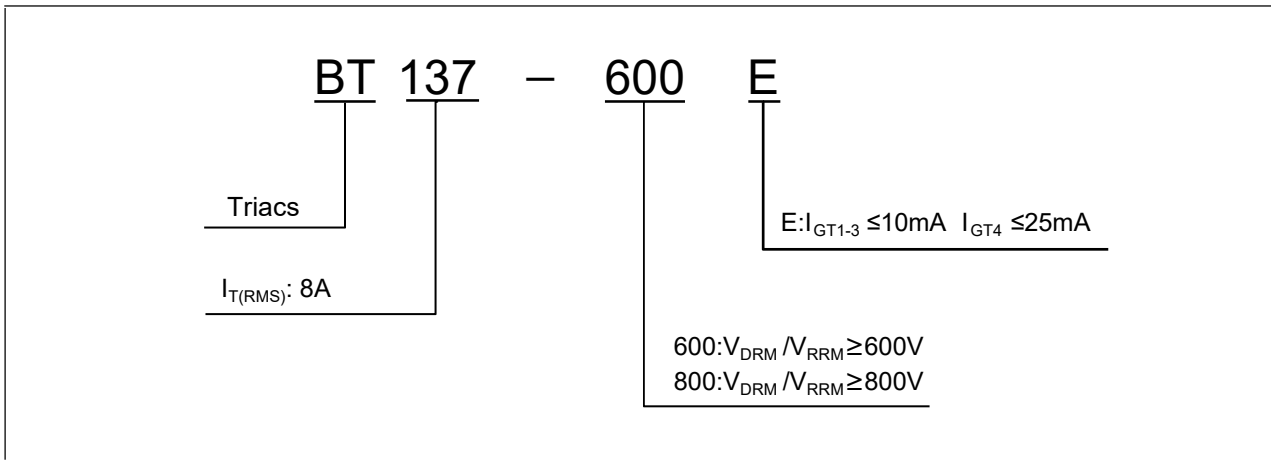

FIG.6: Relative variations of gate trigger current, holding current and latching current versus junction temperature (typical values)



Ordering Information



TO-220C Package Information

