

## 1.8-V, 7-MHz, 90-dB CMRR, SINGLE-SUPPLY, RAIL-TO-RAIL I/O OPERATIONAL AMPLIFIER

### FEATURES

- Qualified for Automotive Applications
- 1.8-V Operation
- Bandwidth: 7 MHz
- CMRR: 90 dB (Typ)
- Slew Rate: 5 V/μs
- Low Offset: 500 μV (Max)
- Quiescent Current: 750 μA/Channel (Max)
- Shutdown Mode: <1 μA/Channel

### APPLICATIONS

- Signal Conditioning
- Data Acquisition
- Process Control
- Active Filters
- Test Equipment

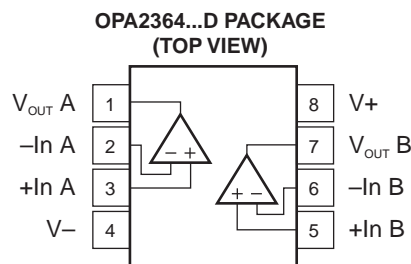
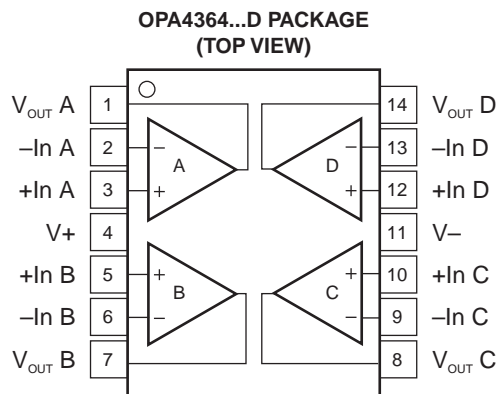

### DESCRIPTION

The OPA2364 and OPA4364 are high-performance CMOS operational amplifiers optimized for low-voltage single-supply operation. These miniature low-cost amplifiers are designed to operate on single supplies from 1.8 V ( $\pm 0.9$  V) to 5.5 V ( $\pm 2.75$  V). Applications include sensor amplification and signal conditioning in battery-powered systems.

The OPAx364 family offers excellent CMRR without the crossover associated with traditional complimentary input stages. This results in excellent performance for driving analog-to-digital (A/D) converters without degradation of differential linearity and total harmonic distortion (THD). The input common-mode range includes both the negative and positive supplies. The output voltage swing is within 10 mV of the rails.

The dual version is available in an SO-8 package and the quad package is available in an SO-14 package. All versions are specified for operation from  $-40^{\circ}\text{C}$  to  $125^{\circ}\text{C}$ .



Please be aware that an important notice concerning availability, standard warranty, and use in critical applications of Texas Instruments semiconductor products and disclaimers thereto appears at the end of this data sheet.



This integrated circuit can be damaged by ESD. Texas Instruments recommends that all integrated circuits be handled with appropriate precautions. Failure to observe proper handling and installation procedures can cause damage.

ESD damage can range from subtle performance degradation to complete device failure. Precision integrated circuits may be more susceptible to damage because very small parametric changes could cause the device not to meet its published specifications.

**ORDERING INFORMATION**

PRODUCT	PACKAGE LEAD	PACKAGE DESIGNATOR	T <sub>A</sub>	PACKAGE MARKING	ORDERING NUMBER	TRANSPORT MEDIA, QUANTITY
OPA2364AQDRQ1	SO-8	D	–40°C to 125°C	OP2364	OPA2364AQDRQ1	Tape and reel, 2500
OPA4364AQDRQ1	SO-14	D	–40°C to 125°C	OPA4364AQ	OPA4364AQDRQ1	Tape and reel, 2500

**ABSOLUTE MAXIMUM RATINGS<sup>(1)</sup>**

over operating free-air temperature range (unless otherwise noted)

		MIN	MAX	UNIT
Supply voltage			5.5	V
Signal input terminals	Voltage range <sup>(2)</sup>	–0.5	(V+) + 0.5	V
	Current <sup>(2)</sup>		±10	mA
Enable input range		(V–) –0.5	5.5	V
Output short circuit <sup>(3)</sup>			Continuous	
Operating temperature range		–40	150	°C
T <sub>stg</sub> Storage temperature range		–65	150	°C
T <sub>J</sub> Junction temperature			150	°C
Lead temperature (soldering, 10 s)			300	°C

- (1) Stresses above these ratings may cause permanent damage. Exposure to absolute maximum conditions for extended periods may degrade device reliability. These are stress ratings only, and functional operation of the device at these or any other conditions beyond those specified is not implied.
- (2) Input terminals are diode clamped to the power-supply rails. Input signals that can swing more than 0.5 V beyond the supply rails should be current limited to 10 mA or less.
- (3) Short circuit to ground one amplifier per package

**ELECTRICAL CHARACTERISTICS:  $V_S = 1.8\text{ V to }5.5\text{ V}$** 

**Boldface** limits apply over the specified temperature range,  $T_A = -40^\circ\text{C to }125^\circ\text{C}$ ,  $T_A = 25^\circ\text{C}$ ,  $R_L = 10\text{ k}\Omega$  connected to  $V_S/2$ , and  $V_{OUT} = V_S/2$ ,  $V_{CM} = V_S/2$  (unless otherwise noted)

PARAMETER		TEST CONDITIONS	MIN	TYP	MAX	UNIT
<b>Offset Voltage</b>						
$V_{OS}$	Input offset voltage	$V_S = 5\text{ V}$		1	3	mV
$dV_{OS}/dT$	Drift			<b>3</b>		$\mu\text{V}/^\circ\text{C}$
<b>PSRR</b>	<b>Power-supply rejection ratio</b>	<b><math>V_S = 1.8\text{ V to }5.5\text{ V}</math>, <math>V_{CM} = 0</math></b>		<b>80</b>	<b>330</b>	$\mu\text{V}/\text{V}$
	Channel separation, dc			1		$\mu\text{V}/\text{V}$
<b>Input Bias Current</b>						
$I_B$	Input bias current			$\pm 1$	$\pm 10$	$\mu\text{A}$
		<b>Over temperature</b>	See Typical Characteristics			
$I_{OS}$	Input offset current			$\pm 1$	$\pm 10$	$\mu\text{A}$
<b>Noise</b>						
$e_n$	Input voltage noise	$f = 0.1\text{ Hz to }10\text{ Hz}$		10		$\mu\text{V}_{P-P}$
	Input voltage noise density	$f = 10\text{ kHz}$		17		$\text{nV}/\sqrt{\text{Hz}}$
$i_n$	Input current noise density	$f = 10\text{ kHz}$		0.6		$\text{fA}/\sqrt{\text{Hz}}$
<b>Input Voltage Range</b>						
$V_{CM}$	Common-mode voltage range		$(V_-) - 0.1$		$(V_+) + 0.1$	V
<b>CMRR</b>	<b>Common-mode rejection ratio</b>	<b><math>(V_-) - 0.1\text{ V} &lt; V_{CM} &lt; (V_+) + 0.1\text{ V}</math></b>	<b>74</b>	<b>90</b>		<b>dB</b>
<b>Input Capacitance</b>						
	Differential			2		pF
	Common mode			3		pF
<b>Open-Loop Gain</b>						
$A_{OL}$	Open-loop voltage gain	$R_L = 10\text{ k}\Omega$ , $100\text{ mV} < V_O < (V_+) - 100\text{ mV}$	94	100		dB
		OPA4364A	90			
		<b>Over temperature,</b> <b><math>V_S = 1.8\text{ V to }5.5\text{ V}</math></b>	<b>86</b>			<b>dB</b>
<b>Frequency Response</b>						
GBW	Gain bandwidth product	$C_L = 100\text{ pF}$		7		MHz
SR	Slew rate	$C_L = 100\text{ pF}$ , $G = 1$		5		$\text{V}/\mu\text{s}$
$t_s$	Settling time	0.1%	$C_L = 100\text{ pF}$ , $V_S = 5\text{ V}$ , 4-V step, $G = 1$	1		$\mu\text{s}$
		0.01%	$C_L = 100\text{ pF}$ , $V_S = 5\text{ V}$ , 4-V step, $G = 1$	1.5		$\mu\text{s}$
	Overload recovery time	$C_L = 100\text{ pF}$ , $V_{IN} \times \text{Gain} > V_S$		0.8		$\mu\text{s}$
THD+N	Total harmonic distortion + noise	$C_L = 100\text{ pF}$ , $V_S = 5\text{ V}$ , $G = 1$ , $f = 20\text{ Hz to }20\text{ kHz}$		0.002%		
<b>Output</b>						
Voltage output swing	From rail	$R_L = 10\text{ k}\Omega$		10	20	mV
	<b>Over temperature</b>	$R_L = 10\text{ k}\Omega$	$V_{OL}$		<b>20</b>	mV
			$V_{OH}$		<b>40</b>	
$I_{SC}$	Short-circuit current		See Typical Characteristics			
$C_{LOAD}$	Capacitive load drive		See Typical Characteristics			
<b>Power Supply</b>						
$V_S$	Specified voltage		1.8		5.5	V
	Operating voltage		1.8 to 5.5			V
$I_Q$	Quiescent current (per amplifier)	$V_S = 1.8\text{ V}$		<b>650</b>	<b>750</b>	$\mu\text{A}$
		$V_S = 3.6\text{ V}$		<b>850</b>	<b>1000</b>	$\mu\text{A}$
		$V_S = 5.5\text{ V}$		<b>1.1</b>	<b>1.4</b>	<b>mA</b>

**ELECTRICAL CHARACTERISTICS:  $V_S = 1.8\text{ V to }5.5\text{ V}$  (continued)**

**Boldface** limits apply over the specified temperature range,  $T_A = -40^\circ\text{C to }125^\circ\text{C}$ ,  $T_A = 25^\circ\text{C}$ ,  $R_L = 10\text{ k}\Omega$  connected to  $V_S/2$ , and  $V_{OUT} = V_S/2$ ,  $V_{CM} = V_S/2$  (unless otherwise noted)

PARAMETER		TEST CONDITIONS	MIN	TYP	MAX	UNIT
<b>Temperature Range</b>						
Specified range			-40		125	$^\circ\text{C}$
Storage range			-65		150	$^\circ\text{C}$
$\theta_{JA}$	Thermal resistance	SO-8		150		$^\circ\text{C/W}$
		SO-14		100		

**TYPICAL CHARACTERISTICS**

At  $T_{CASE} = 25^{\circ}C$ ,  $R_L = 10\text{ k}\Omega$ , and connected to  $V_S/2$ ,  $V_{OUT} = V_S/2$ ,  $V_{CM} = V_S/2$  (unless otherwise noted)

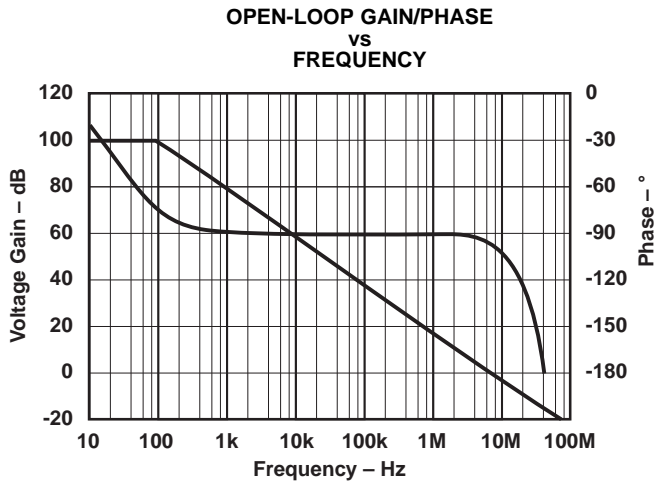

Figure 1.

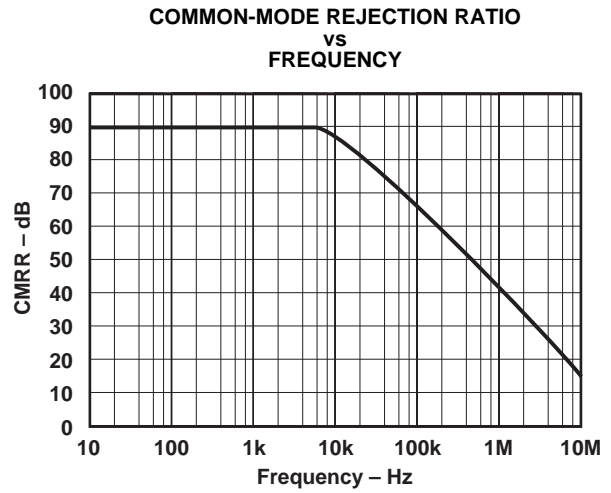

Figure 2.

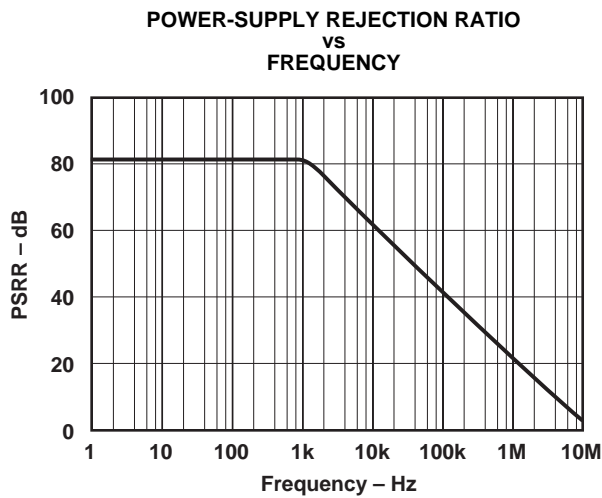

Figure 3.

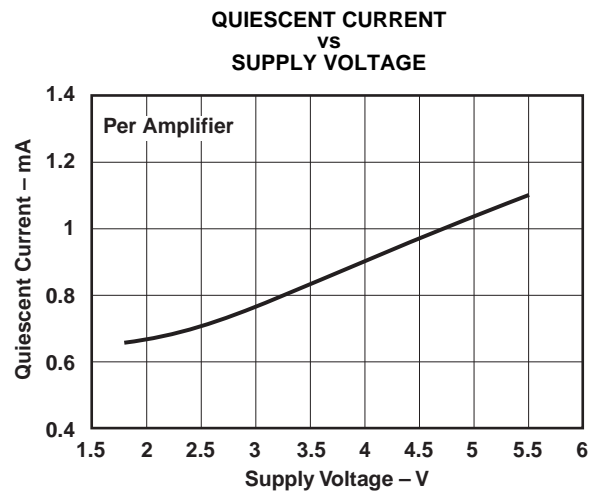

Figure 4.

**TYPICAL CHARACTERISTICS (continued)**

At  $T_{CASE} = 25^{\circ}C$ ,  $R_L = 10\text{ k}\Omega$ , and connected to  $V_S/2$ ,  $V_{OUT} = V_S/2$ ,  $V_{CM} = V_S/2$  (unless otherwise noted)

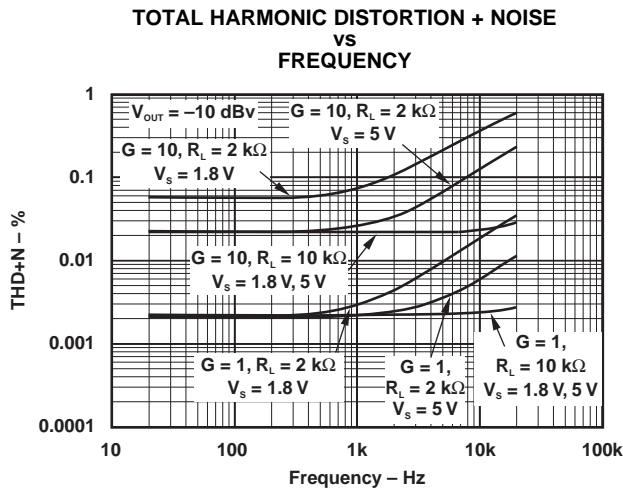

Figure 5.

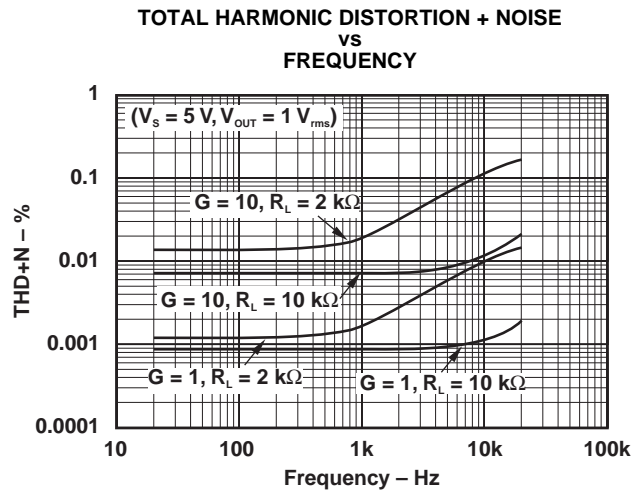

Figure 6.

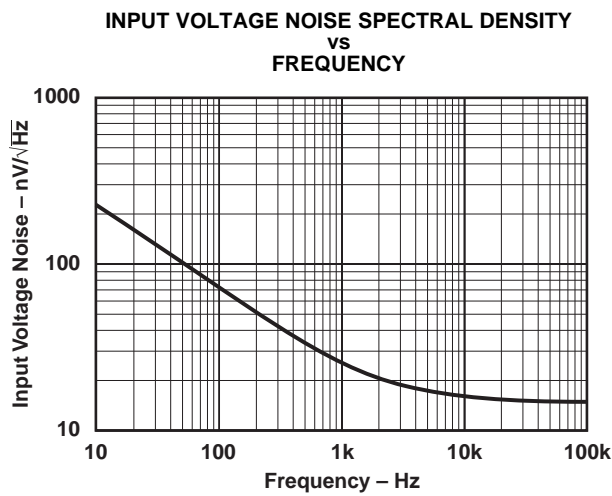

Figure 7.

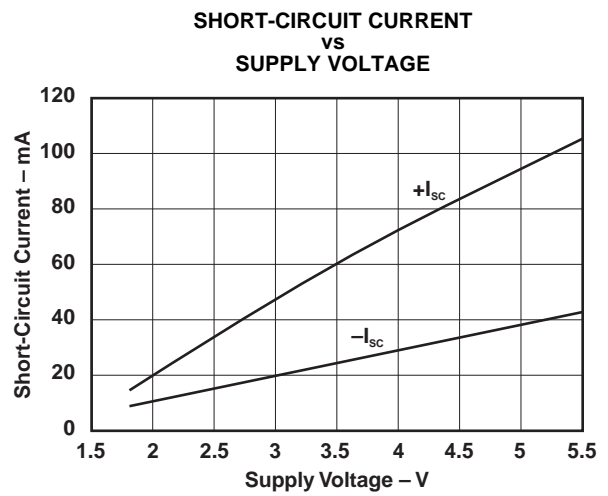

Figure 8.

**TYPICAL CHARACTERISTICS (continued)**

At  $T_{CASE} = 25^{\circ}C$ ,  $R_L = 10\text{ k}\Omega$ , and connected to  $V_S/2$ ,  $V_{OUT} = V_S/2$ ,  $V_{CM} = V_S/2$  (unless otherwise noted)

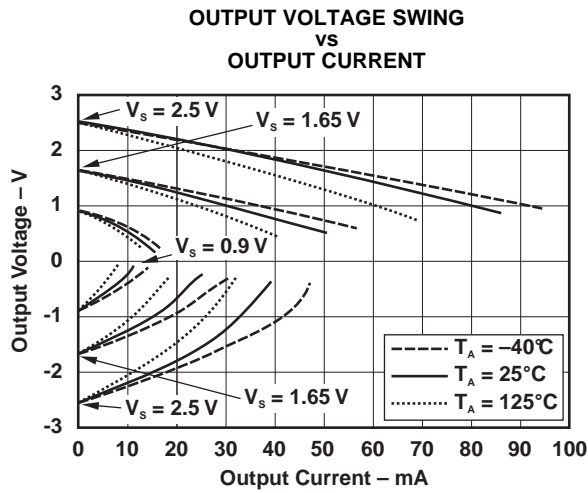

Figure 9.

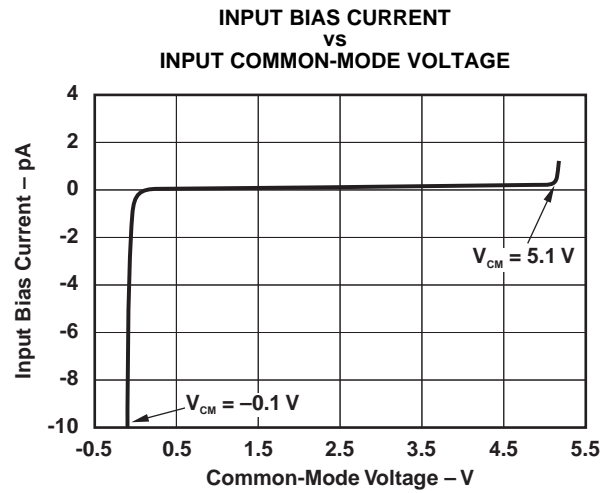

Figure 10.

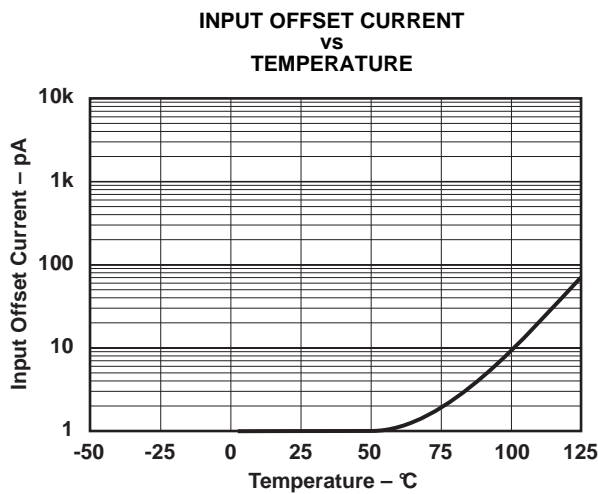

Figure 11.

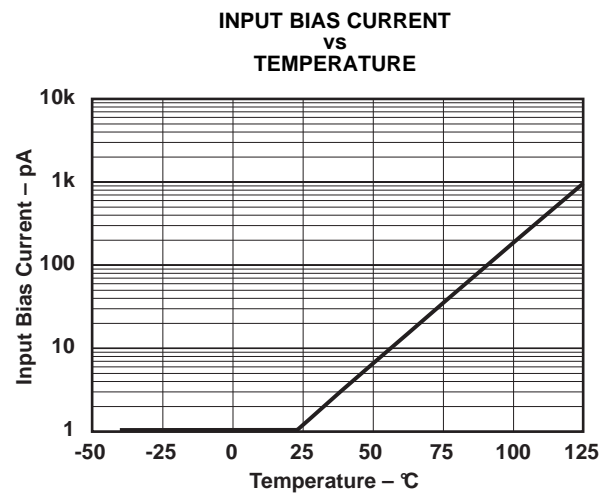

Figure 12.

**TYPICAL CHARACTERISTICS (continued)**

At  $T_{CASE} = 25^{\circ}C$ ,  $R_L = 10\text{ k}\Omega$ , and connected to  $V_S/2$ ,  $V_{OUT} = V_S/2$ ,  $V_{CM} = V_S/2$  (unless otherwise noted)

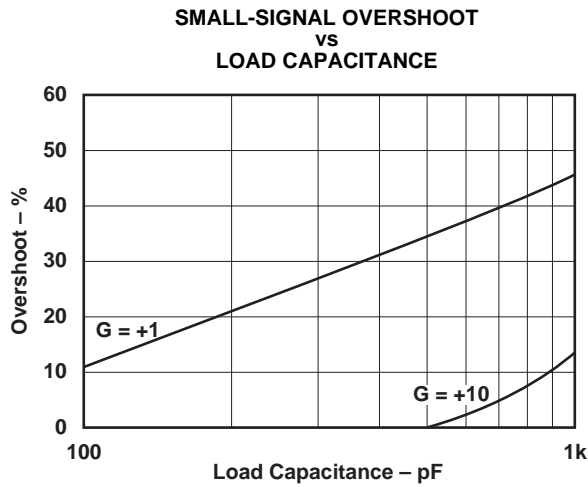

Figure 13.

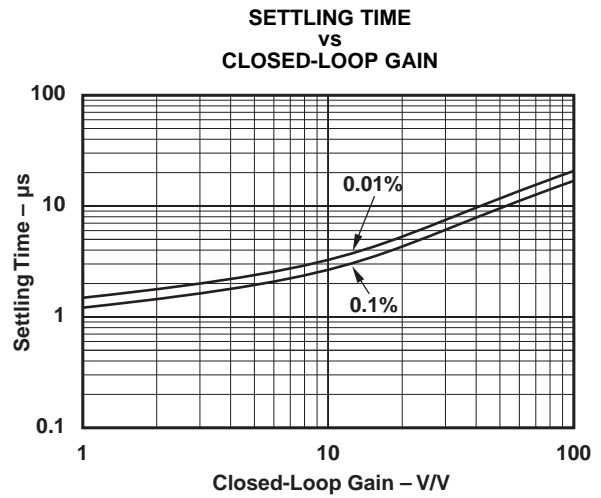

Figure 14.

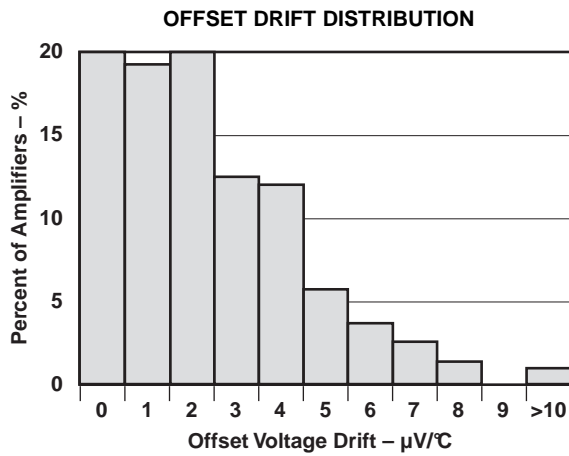

Figure 15.

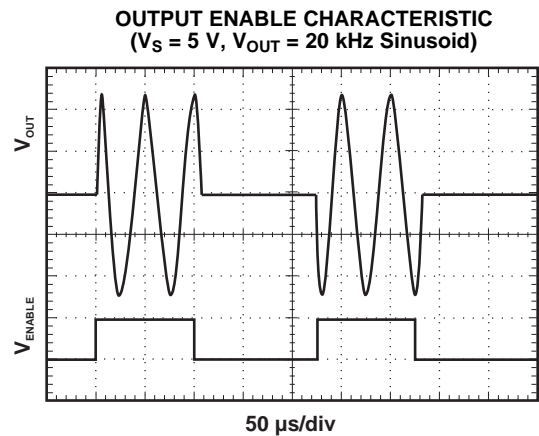

Figure 16.



**TYPICAL CHARACTERISTICS (continued)**

At  $T_{CASE} = 25^{\circ}C$ ,  $R_L = 10\text{ k}\Omega$ , and connected to  $V_S/2$ ,  $V_{OUT} = V_S/2$ ,  $V_{CM} = V_S/2$  (unless otherwise noted)

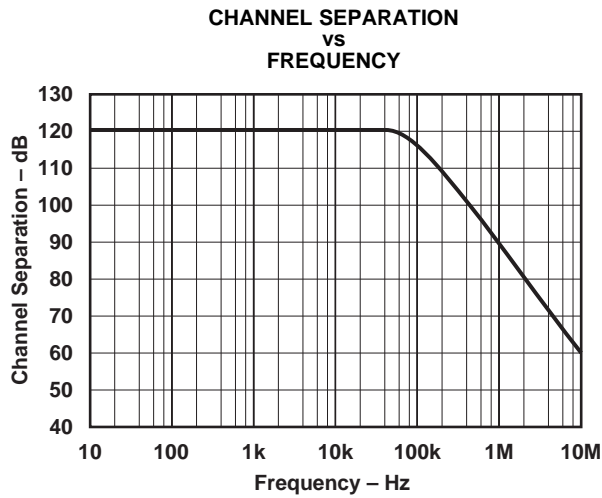

Figure 17.

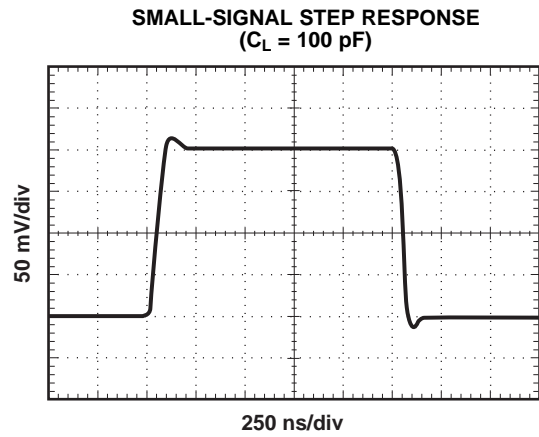

Figure 18.

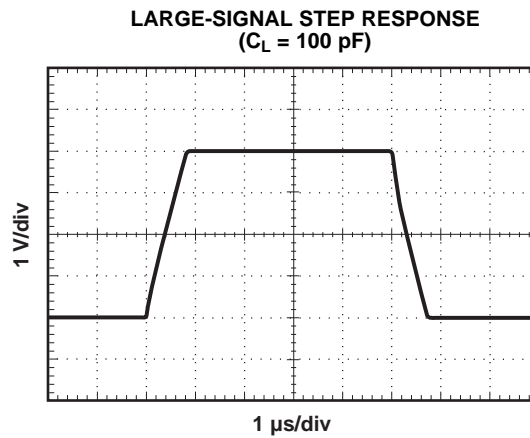

Figure 19.

**APPLICATION INFORMATION**

The OPAx364 series op amps are rail-to-rail operational amplifiers with excellent CMRR, low noise, low offset, and wide bandwidth on supply voltages as low as  $\pm 0.9$  V. This family does not exhibit phase reversal and is unity-gain stable. Specified over the industrial temperature range of  $-40^{\circ}\text{C}$  to  $125^{\circ}\text{C}$ , the OPAx364 family offers precision performance for a wide range of applications.

**Rail-to-Rail Input**

The OPAx364 features excellent rail-to-rail operation, with supply voltages as low as  $\pm 0.9$  V. The input common-mode voltage range of the OPAx364 family extends 100 mV beyond supply rails. The unique input topology of the OPAx364 eliminates the input offset transition region typical of most rail-to-rail complimentary stage operational amplifiers, allowing the OPAx364 to provide superior common-mode performance over the entire common-mode input range (see Figure 20). This feature prevents degradation of the differential linearity error and THD when driving A/D converters. A simplified schematic of the OPAx364 is shown in Figure 21.

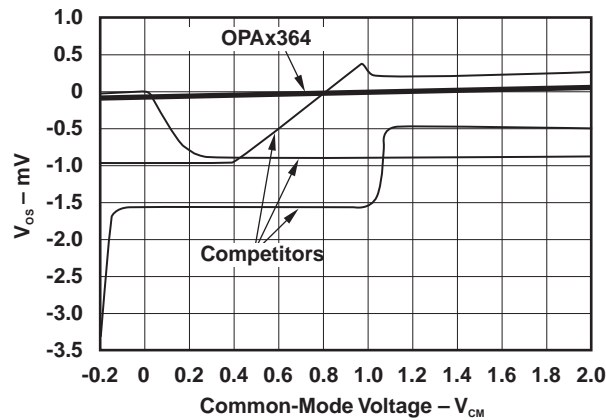

**Figure 20. OPAx364 Linear Offset Over Entire Common-Mode Range**

**APPLICATION INFORMATION (continued)**

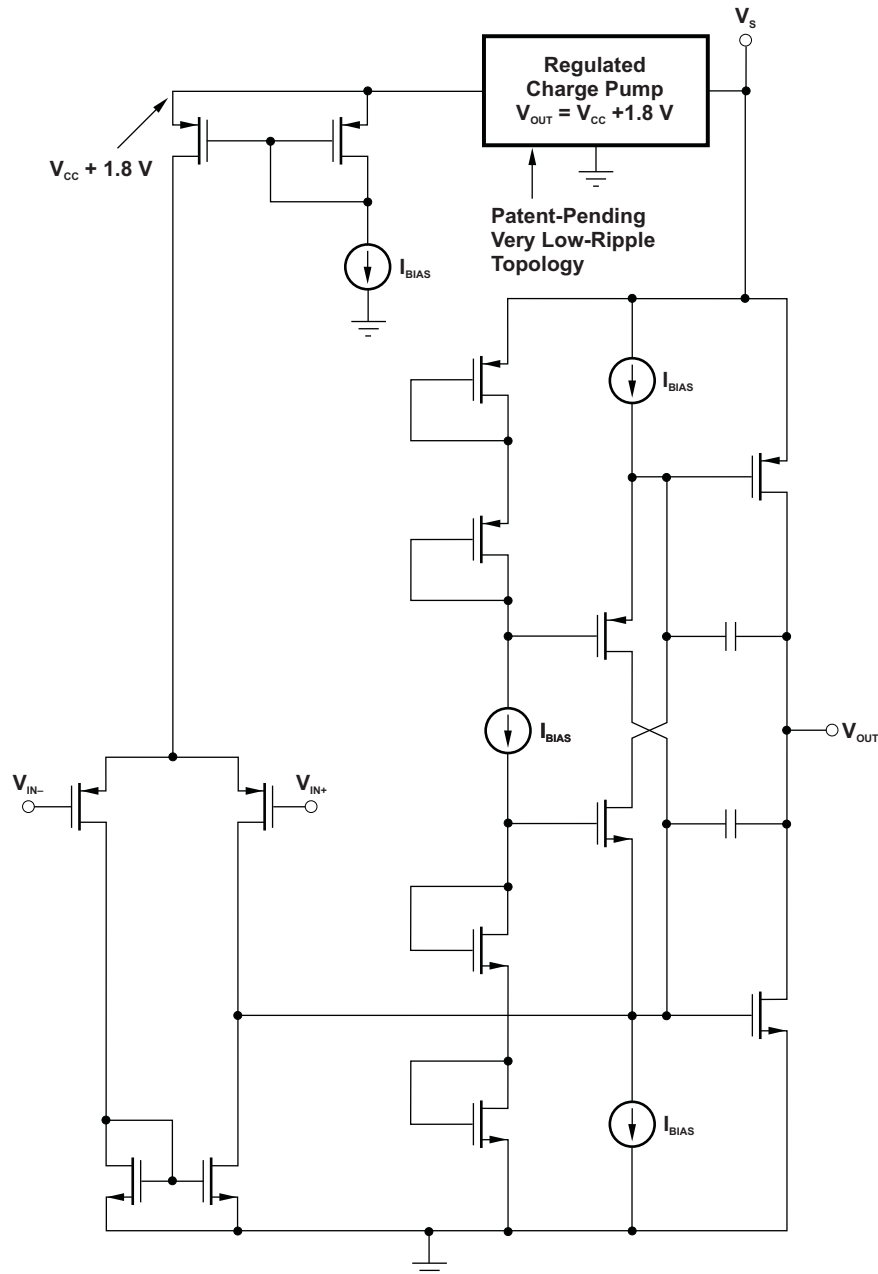

**Figure 21. Simplified Schematic**

**Operating Voltage**

The OPAx364 series of operational amplifier parameters are fully specified from 1.8 V to 5.5 V. Single 0.1- $\mu$ F bypass capacitors should be placed across supply pins and as close to the part as possible. Supply voltages higher than 5.5 V (absolute maximum) may cause permanent damage to the amplifier. Many specifications apply from  $-40^{\circ}\text{C}$  to  $125^{\circ}\text{C}$ . Parameters that vary significantly with operating voltages or temperature are shown in the Typical Characteristics.

## APPLICATION INFORMATION (continued)

### Capacitive Load

The OPAx364 series operational amplifiers can drive a wide range of capacitive loads. However, all operational amplifiers under certain conditions may become unstable. Operational amplifier configuration, gain, and load value are just a few of the factors to consider when determining stability. An operational amplifier in unity-gain configuration is the most susceptible to the effects of capacitive load. The capacitive load reacts with the output resistance of the operational amplifier to create a pole in the small-signal response, which degrades the phase margin.

In unity gain, the OPAx364 series operational amplifiers perform well with a pure capacitive load up to approximately 1000 pF. The equivalent series resistance (ESR) of the loading capacitor may be sufficient to allow the OPAx364 to directly drive large capacitive loads ( $>1 \mu\text{F}$ ). Increasing gain enhances the amplifier's ability to drive more capacitance as shown in [Figure 13](#).

One method of improving capacitive load drive in the unity gain configuration is to insert a 10- $\Omega$  to 20- $\Omega$  resistor in series with the output, as shown in [Figure 22](#). This significantly reduces ringing with large capacitive loads. However, if there is a resistive load in parallel with the capacitive load, it creates a voltage divider introducing a dc error at the output and slightly reduces output swing. This error may be insignificant. For instance, with  $R_L = 10 \text{ k}\Omega$  and  $R_S = 20 \Omega$ , there is only about a 0.2% error at the output.

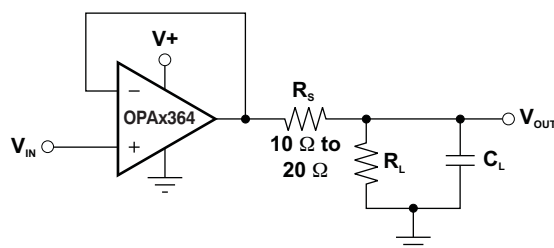

Figure 22. Improving Capacitive Load Drive

### Input and ESD Protection

All OPAx364 pins are static protected with internal ESD protection diodes tied to the supplies. These diodes provide overdrive protection if the current is externally limited to 10 mA, as stated in the absolute maximum ratings and shown in [Figure 23](#).

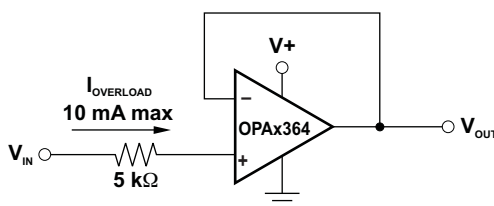

Figure 23. Input Current Protection

### Achieving Output Swing to the Operational Amplifier's Negative Rail

Some applications require an accurate output voltage swing from 0 V to a positive full-scale voltage. A good single-supply operational amplifier may be able to swing within a few mV of single supply ground, but as the output is driven toward 0 V, the output stage of the amplifier prevents the output from reaching the negative supply rail of the amplifier.

The output of the OPAx364 can be made to swing to ground, or slightly below, on a single-supply power source. To do so requires use of another resistor and an additional, more-negative power supply than the operational amplifier's negative supply. A pulldown resistor may be connected between the output and the additional negative supply to pull the output down below the value that the output would otherwise achieve as shown in [Figure 24](#).

**APPLICATION INFORMATION (continued)**

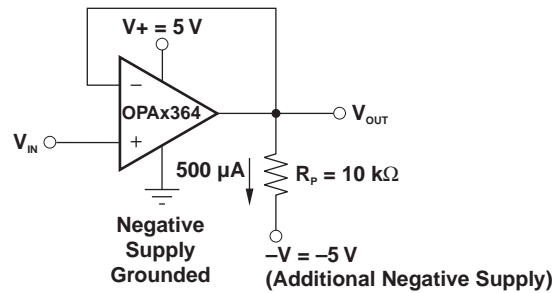
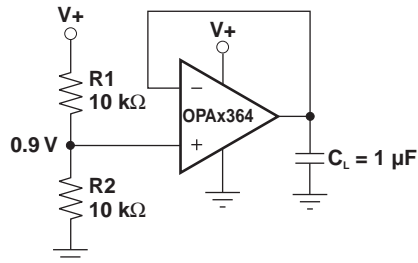

**Figure 24. Swing to Ground**

This technique does not work with all operational amplifiers. The output stage of the OPAx364 allows the output voltage to be pulled below that of most operational amplifiers, if approximately 500  $\mu\text{A}$  is maintained through the output stage. To calculate the appropriate value load resistor and negative supply,  $R_L = -V/500 \mu\text{A}$ . The OPAx364 has been characterized to perform well under the described conditions, maintaining excellent accuracy down to 0 V and as low as  $-10 \text{ mV}$ . Limiting and nonlinearity occurs below  $-10 \text{ mV}$ , with linearity returning as the output is again driven above  $-10 \text{ mV}$ .

**Buffered Reference Voltage**

Many single-supply applications require a mid-supply reference voltage. The OPAx364 offer excellent capacitive load drive capability and can be configured to provide a 0.9-V reference voltage (see [Figure 25](#)). For appropriate loading considerations, see the Capacitive Load section.

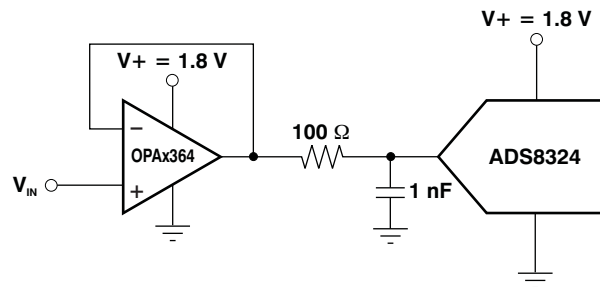

**Figure 25. OPAx364 Provides a Stable Reference Voltage**

**APPLICATION INFORMATION (continued)**

**Directly Driving the ADS8324 and the MSP430**

The OPAx364 series operational amplifiers are optimized for driving medium speed (up to 100 kHz) sampling A/D converters. However, they also offer excellent performance for higher-speed converters. The no crossover input stage of the OPAx364 directly drives A/D converters without degradation of differential linearity and THD. They provide an effective means of buffering the A/D converters input capacitance and resulting charge injection, while providing signal gain. Figure 26 and Figure 27 show the OPAx364 configured to drive the ADS8324 and the 12-bit A/D converter on the MSP430.



**Figure 26. OPAx364 Directly Drives the ADS8324**

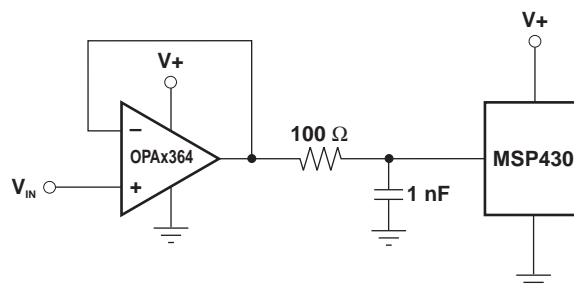

**Figure 27. Driving the 12-Bit A/D Converter on the MSP430**

**Audio Applications**

The OPAx364 family has linear offset voltage over the entire input common-mode range. Combined with low-noise, this feature makes the OPAx364 suitable for audio applications. Single-supply 1.8-V operation allows the OPA2364 to be an optimal candidate for dual stereo-headphone drivers and microphone preamplifiers in portable stereo equipment (see Figure 28).

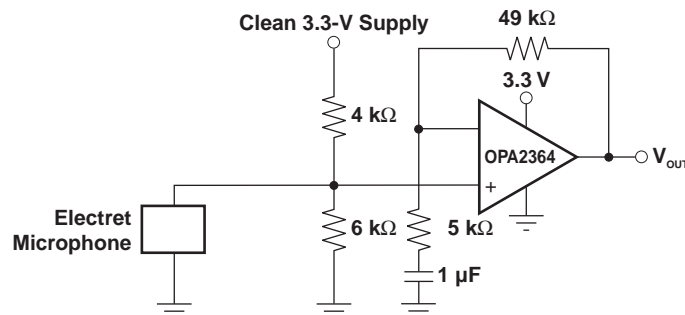
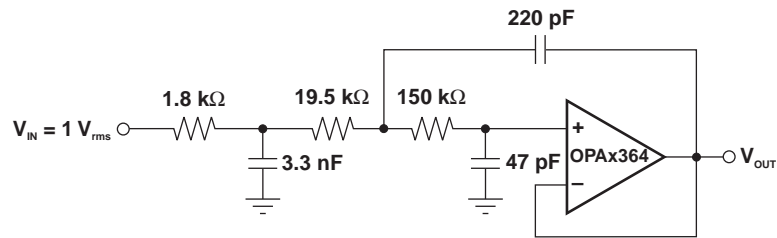

**Figure 28. Microphone Preamplifier**

**APPLICATION INFORMATION (continued)**

**Active Filtering**

Low harmonic distortion and noise specifications plus high gain and slew rate make the OPAx364 optimal candidates for active filtering. Figure 29 shows the implementation of a Sallen-Key, 3-pole, low-pass Bessel filter.



**Figure 29. OPAx364 Configured as 3-Pole, 20-kHz, Sallen-Key Filter**

**PACKAGING INFORMATION**

Orderable Device	Status <sup>(1)</sup>	Package Type	Package Drawing	Pins	Package Qty	Eco Plan <sup>(2)</sup>	Lead/Ball Finish	MSL Peak Temp <sup>(3)</sup>
OPA4364AQRDQ1	ACTIVE	SOIC	D	14	2500	Green (RoHS & no Sb/Br)	CU NIPDAU	Level-1-260C-UNLIM

<sup>(1)</sup> The marketing status values are defined as follows:

**ACTIVE:** Product device recommended for new designs.

**LIFEBUY:** TI has announced that the device will be discontinued, and a lifetime-buy period is in effect.

**NRND:** Not recommended for new designs. Device is in production to support existing customers, but TI does not recommend using this part in a new design.

**PREVIEW:** Device has been announced but is not in production. Samples may or may not be available.

**OBSOLETE:** TI has discontinued the production of the device.

<sup>(2)</sup> Eco Plan - The planned eco-friendly classification: Pb-Free (RoHS), Pb-Free (RoHS Exempt), or Green (RoHS & no Sb/Br) - please check <http://www.ti.com/productcontent> for the latest availability information and additional product content details.

**TBD:** The Pb-Free/Green conversion plan has not been defined.

**Pb-Free (RoHS):** TI's terms "Lead-Free" or "Pb-Free" mean semiconductor products that are compatible with the current RoHS requirements for all 6 substances, including the requirement that lead not exceed 0.1% by weight in homogeneous materials. Where designed to be soldered at high temperatures, TI Pb-Free products are suitable for use in specified lead-free processes.

**Pb-Free (RoHS Exempt):** This component has a RoHS exemption for either 1) lead-based flip-chip solder bumps used between the die and package, or 2) lead-based die adhesive used between the die and leadframe. The component is otherwise considered Pb-Free (RoHS compatible) as defined above.

**Green (RoHS & no Sb/Br):** TI defines "Green" to mean Pb-Free (RoHS compatible), and free of Bromine (Br) and Antimony (Sb) based flame retardants (Br or Sb do not exceed 0.1% by weight in homogeneous material)

<sup>(3)</sup> MSL, Peak Temp. -- The Moisture Sensitivity Level rating according to the JEDEC industry standard classifications, and peak solder temperature.

**Important Information and Disclaimer:**The information provided on this page represents TI's knowledge and belief as of the date that it is provided. TI bases its knowledge and belief on information provided by third parties, and makes no representation or warranty as to the accuracy of such information. Efforts are underway to better integrate information from third parties. TI has taken and continues to take reasonable steps to provide representative and accurate information but may not have conducted destructive testing or chemical analysis on incoming materials and chemicals. TI and TI suppliers consider certain information to be proprietary, and thus CAS numbers and other limited information may not be available for release.

In no event shall TI's liability arising out of such information exceed the total purchase price of the TI part(s) at issue in this document sold by TI to Customer on an annual basis.

**OTHER QUALIFIED VERSIONS OF OPA4364-Q1 :**

- Catalog: [OPA4364](#)

NOTE: Qualified Version Definitions:

- Catalog - TI's standard catalog product



**TAPE AND REEL INFORMATION**

**REEL DIMENSIONS**

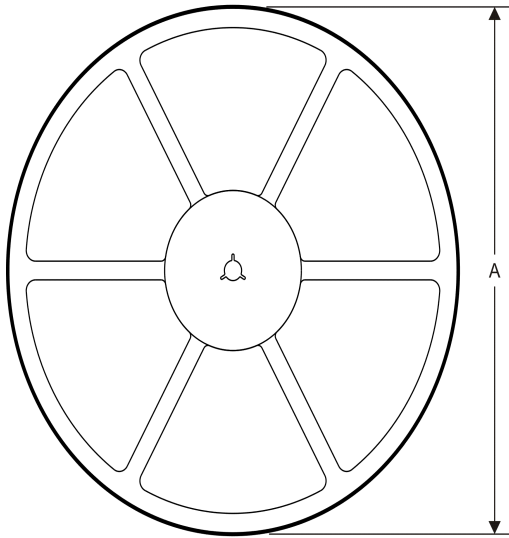

**TAPE DIMENSIONS**



A0	Dimension designed to accommodate the component width
B0	Dimension designed to accommodate the component length
K0	Dimension designed to accommodate the component thickness
W	Overall width of the carrier tape
P1	Pitch between successive cavity centers

**TAPE AND REEL INFORMATION**

\*All dimensions are nominal

Device	Package Type	Package Drawing	Pins	SPQ	Reel Diameter (mm)	Reel Width W1 (mm)	A0 (mm)	B0 (mm)	K0 (mm)	P1 (mm)	W (mm)	Pin1 Quadrant
OPA4364AQDRQ1	SOIC	D	14	2500	330.0	16.4	6.5	9.0	2.1	8.0	16.0	Q1

**TAPE AND REEL BOX DIMENSIONS**



\*All dimensions are nominal

Device	Package Type	Package Drawing	Pins	SPQ	Length (mm)	Width (mm)	Height (mm)
OPA4364AQDRQ1	SOIC	D	14	2500	367.0	367.0	38.0

D (R-PDSO-G14)

PLASTIC SMALL OUTLINE



- NOTES:
- A. All linear dimensions are in inches (millimeters).
  - B. This drawing is subject to change without notice.
  - Body length does not include mold flash, protrusions, or gate burrs. Mold flash, protrusions, or gate burrs shall not exceed 0.006 (0,15) each side.
  - Body width does not include interlead flash. Interlead flash shall not exceed 0.017 (0,43) each side.
  - E. Reference JEDEC MS-012 variation AB.

D (R-PDSO-G14)

PLASTIC SMALL OUTLINE



- NOTES:
- A. All linear dimensions are in millimeters.
  - B. This drawing is subject to change without notice.
  - C. Publication IPC-7351 is recommended for alternate designs.
  - D. Laser cutting apertures with trapezoidal walls and also rounding corners will offer better paste release. Customers should contact their board assembly site for stencil design recommendations. Refer to IPC-7525 for other stencil recommendations.
  - E. Customers should contact their board fabrication site for solder mask tolerances between and around signal pads.

## IMPORTANT NOTICE

Texas Instruments Incorporated and its subsidiaries (TI) reserve the right to make corrections, enhancements, improvements and other changes to its semiconductor products and services per JESD46, latest issue, and to discontinue any product or service per JESD48, latest issue. Buyers should obtain the latest relevant information before placing orders and should verify that such information is current and complete. All semiconductor products (also referred to herein as "components") are sold subject to TI's terms and conditions of sale supplied at the time of order acknowledgment.

TI warrants performance of its components to the specifications applicable at the time of sale, in accordance with the warranty in TI's terms and conditions of sale of semiconductor products. Testing and other quality control techniques are used to the extent TI deems necessary to support this warranty. Except where mandated by applicable law, testing of all parameters of each component is not necessarily performed.

TI assumes no liability for applications assistance or the design of Buyers' products. Buyers are responsible for their products and applications using TI components. To minimize the risks associated with Buyers' products and applications, Buyers should provide adequate design and operating safeguards.

TI does not warrant or represent that any license, either express or implied, is granted under any patent right, copyright, mask work right, or other intellectual property right relating to any combination, machine, or process in which TI components or services are used. Information published by TI regarding third-party products or services does not constitute a license to use such products or services or a warranty or endorsement thereof. Use of such information may require a license from a third party under the patents or other intellectual property of the third party, or a license from TI under the patents or other intellectual property of TI.

Reproduction of significant portions of TI information in TI data books or data sheets is permissible only if reproduction is without alteration and is accompanied by all associated warranties, conditions, limitations, and notices. TI is not responsible or liable for such altered documentation. Information of third parties may be subject to additional restrictions.

Resale of TI components or services with statements different from or beyond the parameters stated by TI for that component or service voids all express and any implied warranties for the associated TI component or service and is an unfair and deceptive business practice. TI is not responsible or liable for any such statements.

Buyer acknowledges and agrees that it is solely responsible for compliance with all legal, regulatory and safety-related requirements concerning its products, and any use of TI components in its applications, notwithstanding any applications-related information or support that may be provided by TI. Buyer represents and agrees that it has all the necessary expertise to create and implement safeguards which anticipate dangerous consequences of failures, monitor failures and their consequences, lessen the likelihood of failures that might cause harm and take appropriate remedial actions. Buyer will fully indemnify TI and its representatives against any damages arising out of the use of any TI components in safety-critical applications.

In some cases, TI components may be promoted specifically to facilitate safety-related applications. With such components, TI's goal is to help enable customers to design and create their own end-product solutions that meet applicable functional safety standards and requirements. Nonetheless, such components are subject to these terms.

No TI components are authorized for use in FDA Class III (or similar life-critical medical equipment) unless authorized officers of the parties have executed a special agreement specifically governing such use.

Only those TI components which TI has specifically designated as military grade or "enhanced plastic" are designed and intended for use in military/aerospace applications or environments. Buyer acknowledges and agrees that any military or aerospace use of TI components which have **not** been so designated is solely at the Buyer's risk, and that Buyer is solely responsible for compliance with all legal and regulatory requirements in connection with such use.

TI has specifically designated certain components which meet ISO/TS16949 requirements, mainly for automotive use. Components which have not been so designated are neither designed nor intended for automotive use; and TI will not be responsible for any failure of such components to meet such requirements.

### Products

Audio	<a href="http://www.ti.com/audio">www.ti.com/audio</a>
Amplifiers	<a href="http://amplifier.ti.com">amplifier.ti.com</a>
Data Converters	<a href="http://dataconverter.ti.com">dataconverter.ti.com</a>
DLP® Products	<a href="http://www.dlp.com">www.dlp.com</a>
DSP	<a href="http://dsp.ti.com">dsp.ti.com</a>
Clocks and Timers	<a href="http://www.ti.com/clocks">www.ti.com/clocks</a>
Interface	<a href="http://interface.ti.com">interface.ti.com</a>
Logic	<a href="http://logic.ti.com">logic.ti.com</a>
Power Mgmt	<a href="http://power.ti.com">power.ti.com</a>
Microcontrollers	<a href="http://microcontroller.ti.com">microcontroller.ti.com</a>
RFID	<a href="http://www.ti-rfid.com">www.ti-rfid.com</a>
OMAP Applications Processors	<a href="http://www.ti.com/omap">www.ti.com/omap</a>
Wireless Connectivity	<a href="http://www.ti.com/wirelessconnectivity">www.ti.com/wirelessconnectivity</a>

### Applications

Automotive and Transportation	<a href="http://www.ti.com/automotive">www.ti.com/automotive</a>
Communications and Telecom	<a href="http://www.ti.com/communications">www.ti.com/communications</a>
Computers and Peripherals	<a href="http://www.ti.com/computers">www.ti.com/computers</a>
Consumer Electronics	<a href="http://www.ti.com/consumer-apps">www.ti.com/consumer-apps</a>
Energy and Lighting	<a href="http://www.ti.com/energy">www.ti.com/energy</a>
Industrial	<a href="http://www.ti.com/industrial">www.ti.com/industrial</a>
Medical	<a href="http://www.ti.com/medical">www.ti.com/medical</a>
Security	<a href="http://www.ti.com/security">www.ti.com/security</a>
Space, Avionics and Defense	<a href="http://www.ti.com/space-avionics-defense">www.ti.com/space-avionics-defense</a>
Video and Imaging	<a href="http://www.ti.com/video">www.ti.com/video</a>

### TI E2E Community

[e2e.ti.com](http://e2e.ti.com)