



Common mode filters

For high-speed differential signal line, general differential signal line

ACM-E series

ACM2012E type

ACM2012E

[0805 inch]*

* Dimensions Code JIS[EIA]

REMINDERS FOR USING THESE PRODUCTS

Before using these products, be sure to request the delivery specifications.

SAFETY REMINDERS

Please pay sufficient attention to the warnings for safe designing when using these products.

REMINDERS

- The storage period is less than 6 months. Be sure to follow the storage conditions (Temperature: 5 to 40°C, Humidity: 10 to 75% RH or less).
If the storage period elapses, the soldering of the terminal electrodes may deteriorate.
- Do not use or store in locations where there are conditions such as gas corrosion (salt, acid, alkali, etc.).
- Before soldering, be sure to preheat components.
The preheating temperature should be set so that the temperature difference between the solder temperature and chip temperature does not exceed 150°C.
- Soldering corrections after mounting should be within the range of the conditions determined in the specifications.
If overheated, a short circuit, performance deterioration, or lifespan shortening may occur.
- When embedding a printed circuit board where a chip is mounted to a set, be sure that residual stress is not given to the chip due to the overall distortion of the printed circuit board and partial distortion such as at screw tightening portions.
- Self heating (temperature increase) occurs when the power is turned ON, so the tolerance should be sufficient for the set thermal design.
- Carefully lay out the coil for the circuit board design of the non-magnetic shield type.
A malfunction may occur due to magnetic interference.
- Use a wrist band to discharge static electricity in your body through the grounding wire.
- Do not expose the products to magnets or magnetic fields.
- Do not use for a purpose outside of the contents regulated in the delivery specifications.
- The products listed on this catalog are intended for use in general electronic equipment (AV equipment, telecommunications equipment, home appliances, amusement equipment, computer equipment, personal equipment, office equipment, measurement equipment, industrial robots) under a normal operation and use condition.
The products are not designed or warranted to meet the requirements of the applications listed below, whose performance and/or quality require a more stringent level of safety or reliability, or whose failure, malfunction or trouble could cause serious damage to society, person or property.
If you intend to use the products in the applications listed below or if you have special requirements exceeding the range or conditions set forth in the each catalog, please contact us.

- (1) Aerospace/Aviation equipment
- (2) Transportation equipment (cars, electric trains, ships, etc.)
- (3) Medical equipment
- (4) Power-generation control equipment
- (5) Atomic energy-related equipment
- (6) Seabed equipment
- (7) Transportation control equipment

- (8) Public information-processing equipment
- (9) Military equipment
- (10) Electric heating apparatus, burning equipment
- (11) Disaster prevention/crime prevention equipment
- (12) Safety equipment
- (13) Other applications that are not considered general-purpose applications

When designing your equipment even for general-purpose applications, you are kindly requested to take into consideration securing protection circuit/device or providing backup circuits in your equipment.

Common mode filters

Product compatible with RoHS directive
Halogen-free
Compatible with lead-free solders

For high-speed differential signal line, general differential signal line

Overview of ACM2012E type

FEATURES

- Downsized, low height wound type chip common mode filter that maintains required common mode filter characteristics. Impedance for common mode noise can clear 1000Ω [100MHz], and has excellent EMC suppression.
- Differential mode impedance is suppressed, so there is virtually no affect on high speed signals.

APPLICATION

- Common mode noise countermeasure for high-speed differential signals where influence to the signal is a concern.
- USB line for PCs and peripheral devices.
- IEEE1394 lines and ETHERNET lines for PCs, STBs, etc.
- LCD panel LVDS and Panel Link lines.

PART NUMBER CONSTRUCTION

ACM	2012	E	-	670	-	2P	-	T	00
Series name	LxWxH Dimensions (mm)	Product internal code		Impedance (Ω) at 100MHz		Number of lines		Packaging style	Internal code
	2012 2.0x1.2x1.0	E		670 67 900 90 121 120 181 180 251 250 391 390 681 680 102 1000		2P 2 lines		T ø180mm reel	00 General differential signal line 01 High-speed differential signal line

OPERATING TEMPERATURE RANGE, PACKAGE QUANTITY, PRODUCT WEIGHT

Type	Temperature range		Reel diameter (mm)	Package quantity (pieces/reel)	Individual weight (mg)
	Operating temperature (°C)	Storage temperature* (°C)			
ACM2012E	-40 to +85	-40 to +85	ø180	2,000	8

* The Storage temperature range is for after the circuit board is mounted.

- RoHS Directive Compliant Product: See the following for more details.<https://product.tdk.com/info/en/environment/rohs/index.html>
- Halogen-free: Indicates that Cl content is less than 900ppm, Br content is less than 900ppm, and that the total Cl and Br content is less than 1500ppm.

 Please be sure to request delivery specifications that provide further details on the features and specifications of the products for proper and safe use. Please note that the contents may change without any prior notice due to reasons such as upgrading.

ACM2012E type

RECOMMENDED REFLOW PROFILE

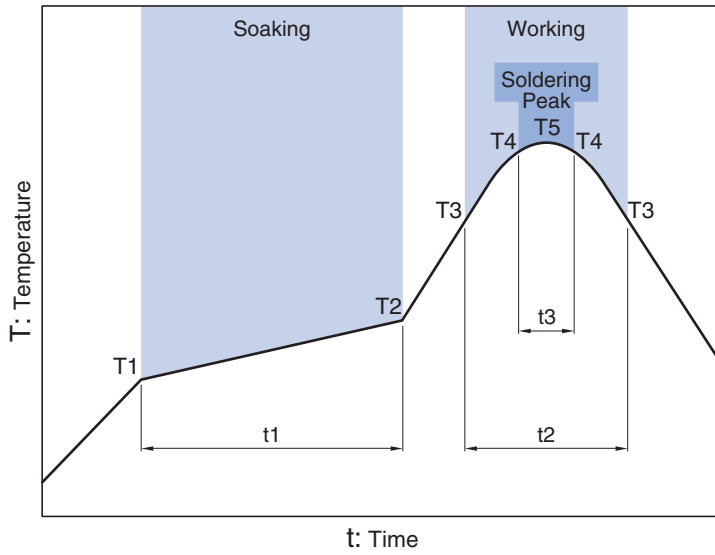

Preheating			Soldering		Peak	
Temp.		Time	Temp.	Time	Temp.	Time
T1	T2	t1	T3	t2	T4	t3
150°C	180°C	60 to 120s	230°C	10 to 30s	245°C	5s

ACM2012E-T00 type (General differential signal line)

SHAPE & DIMENSIONS

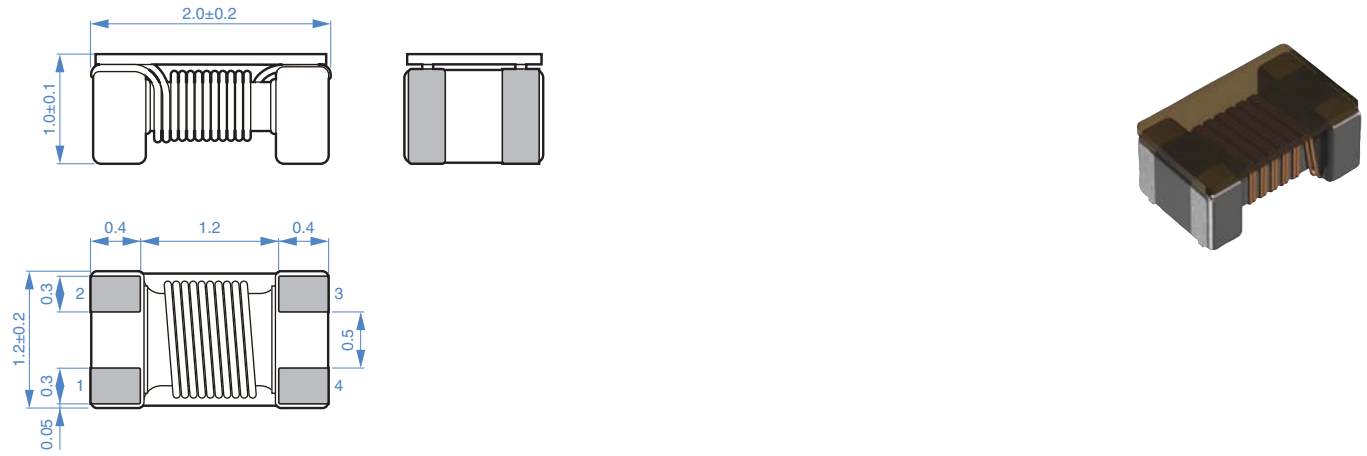

Dimensions in mm

RECOMMENDED LAND PATTERN

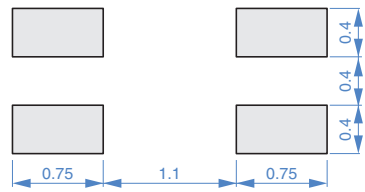

Dimensions in mm

CIRCUIT DIAGRAM

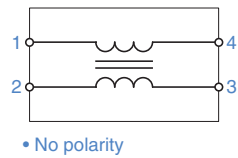

 Please be sure to request delivery specifications that provide further details on the features and specifications of the products for proper and safe use. Please note that the contents may change without any prior notice due to reasons such as upgrading.

ACM2012E-T00 type (General differential signal line)

ELECTRICAL CHARACTERISTICS

CHARACTERISTICS SPECIFICATION TABLE

Impedance [100MHz] (Ω)	DC resistance [1 line] (Ω)max.	Rated voltage (V)max.	Insulation resistance (M Ω)min.	Rated current (A)max.	Part No.
67 \pm 25%	0.35	50	10	0.50	ACM2012E-670-2P-T00
90 \pm 25%	0.35	50	10	0.33	ACM2012E-900-2P-T00
120 \pm 25%	0.45	50	10	0.30	ACM2012E-121-2P-T00
180 \pm 25%	0.60	50	10	0.25	ACM2012E-181-2P-T00
250 \pm 25%	1.00	50	10	0.20	ACM2012E-251-2P-T00
270min. (390typ.)	0.80	50	10	0.30	ACM2012E-391-2P-T00
510min. (680typ.)	1.80	50	10	0.17	ACM2012E-681-2P-T00
750min. (1000typ.)	2.50	50	10	0.15	ACM2012E-102-2P-T00

Measurement equipment

Measurement item	Product No.	Manufacturer
Common mode impedance	4991A	Keysight Technologies
DC resistance	4338A	Keysight Technologies
Insulation resistance	4339A	Keysight Technologies

* Equivalent measurement equipment may be used.

IMPEDANCE VS. FREQUENCY CHARACTERISTICS

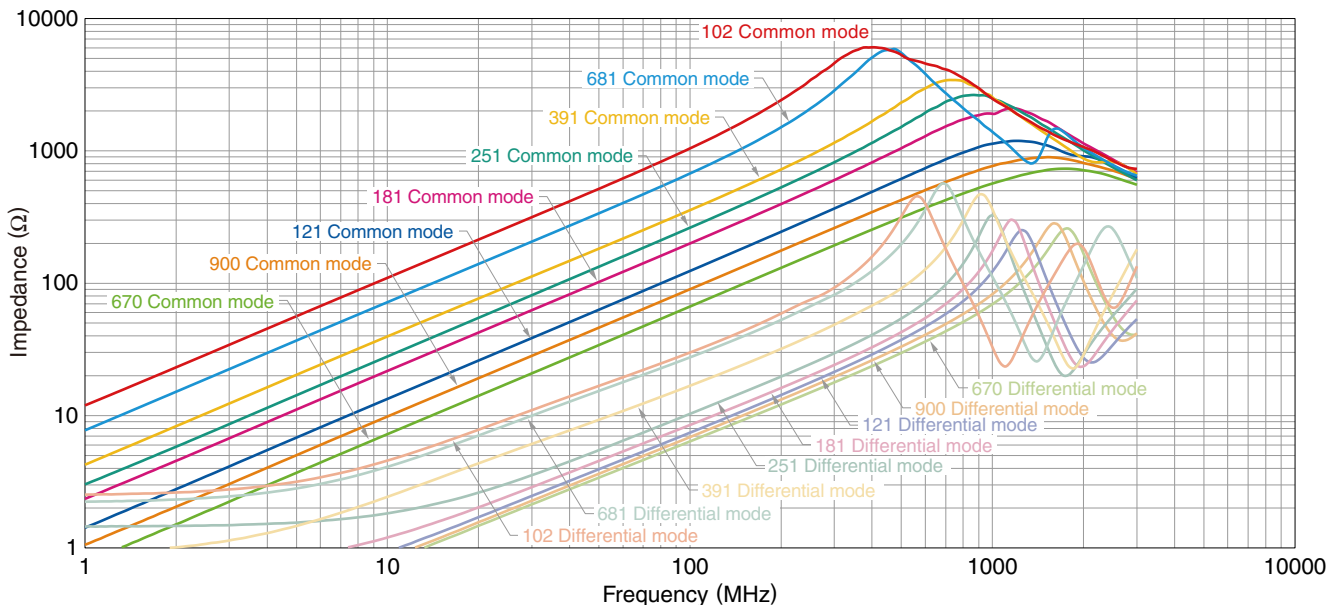

Measurement equipment

Product No.	Manufacturer
4991A	Keysight Technologies

* Equivalent measurement equipment may be used.

! Please be sure to request delivery specifications that provide further details on the features and specifications of the products for proper and safe use. Please note that the contents may change without any prior notice due to reasons such as upgrading.

ACM2012E-T01 type (high-speed differential signal line)

SHAPE & DIMENSIONS

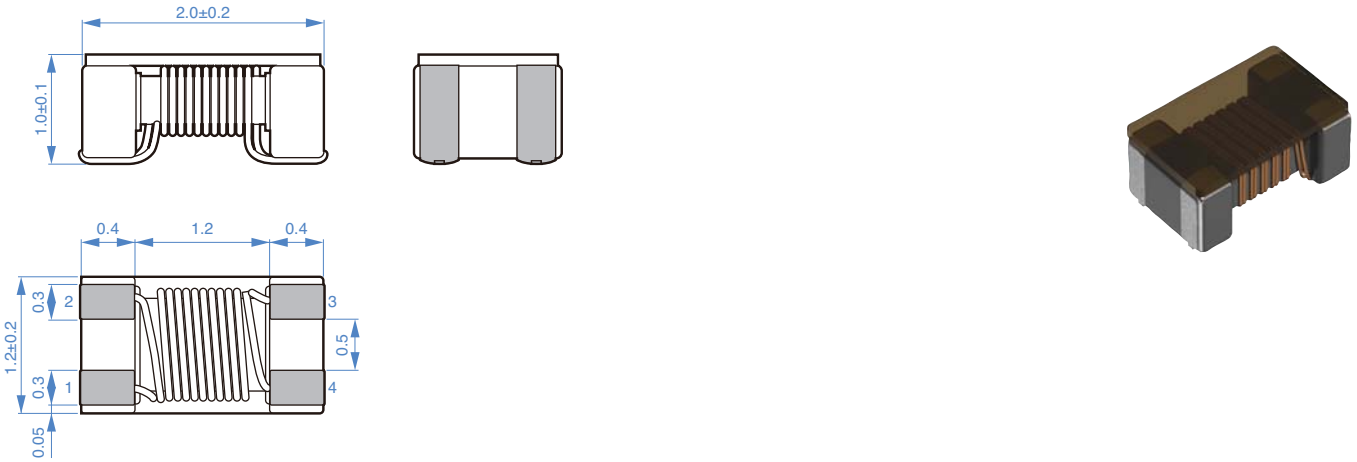

Dimensions in mm

RECOMMENDED LAND PATTERN

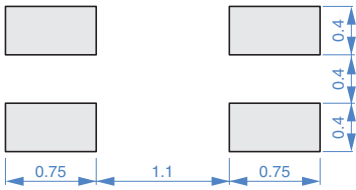

Dimensions in mm

CIRCUIT DIAGRAM

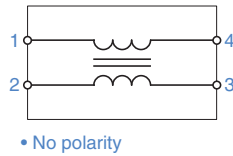

 Please be sure to request delivery specifications that provide further details on the features and specifications of the products for proper and safe use. Please note that the contents may change without any prior notice due to reasons such as upgrading.

ACM2012E-T01 type (high-speed differential signal line)

ELECTRICAL CHARACTERISTICS

CHARACTERISTICS SPECIFICATION TABLE

Impedance [100MHz] (Ω)	DC resistance [1 line] (Ω)max.	Rated voltage (V)max.	Insulation resistance (M Ω)min.	Rated current (A)max.	Part No.
67 \pm 25%	0.45	50	10	0.35	ACM2012E-670-2P-T01
90 \pm 25%	0.55	50	10	0.30	ACM2012E-900-2P-T01
120 \pm 25%	0.65	50	10	0.27	ACM2012E-121-2P-T01

Measurement equipment

Measurement item	Product No.	Manufacturer
Common mode impedance	4991A	Keysight Technologies
DC resistance	4338A	Keysight Technologies
Insulation resistance	4339A	Keysight Technologies

* Equivalent measurement equipment may be used.

IMPEDANCE VS. FREQUENCY CHARACTERISTICS

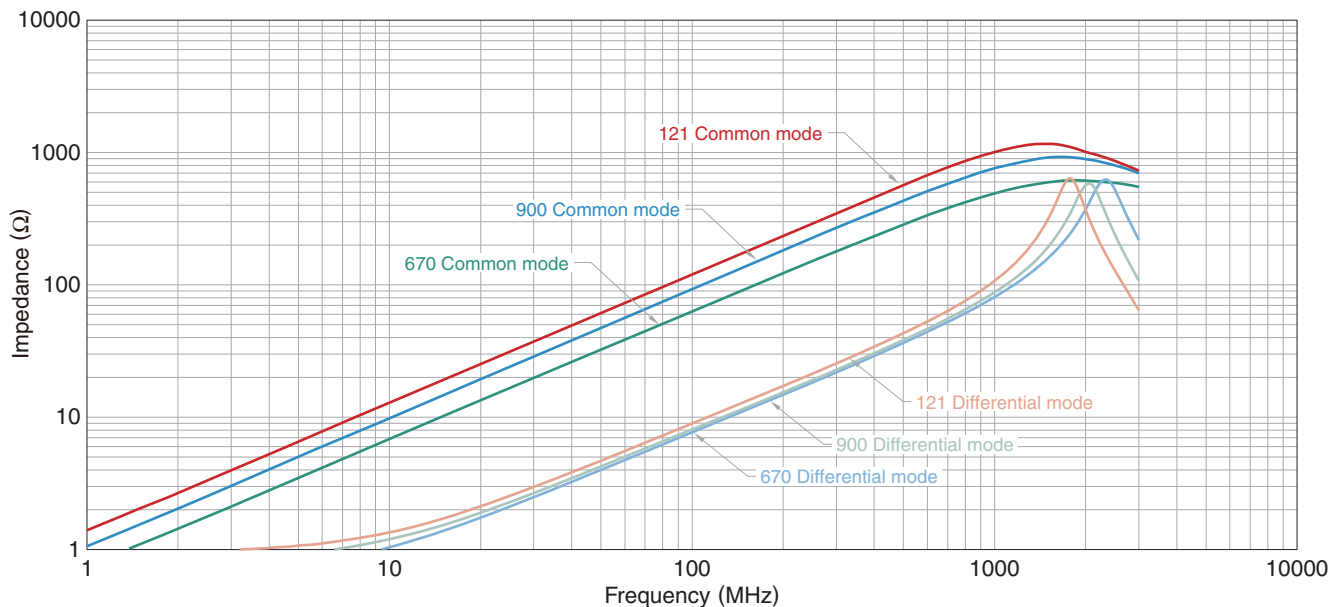

Measurement equipment

Product No.	Manufacturer
4991A	Keysight Technologies

* Equivalent measurement equipment may be used.

! Please be sure to request delivery specifications that provide further details on the features and specifications of the products for proper and safe use. Please note that the contents may change without any prior notice due to reasons such as upgrading.

ACM2012E type

PACKAGING STYLE

REEL DIMENSIONS

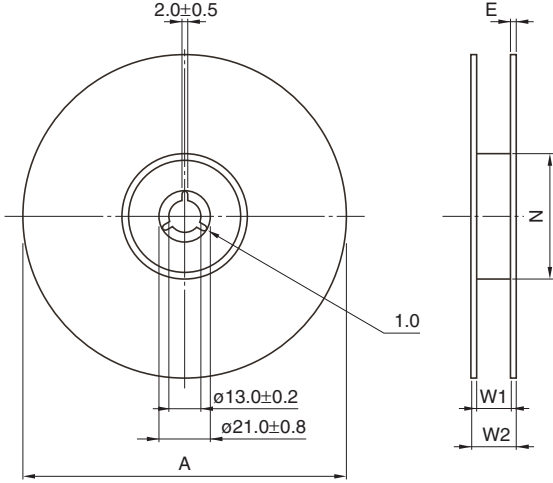

Type	A	W1	W2	N	E
ACM2012E	$\phi 180 \pm 3$	$9 + 1 / - 0$	13 ± 1	$60 + 1 / - 0$	2 typ.

Dimensions in mm

TAPE DIMENSIONS

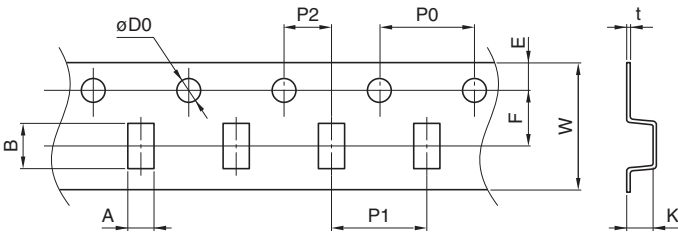

Dimensions in mm

Type	A	B	$\phi D0$	E	F	P0	P1	P2	W	K	t
ACM2012E	1.4 ± 0.1	2.25 ± 0.1	$1.5 + 0.1 / 0$	1.75 ± 0.1	3.5 ± 0.1	4.0 ± 0.1	4.0 ± 0.1	2.0 ± 0.1	8.0 ± 0.2	1.15 ± 0.05	0.20 ± 0.05

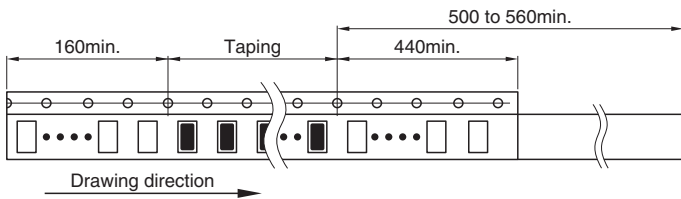

Dimensions in mm

 Please be sure to request delivery specifications that provide further details on the features and specifications of the products for proper and safe use. Please note that the contents may change without any prior notice due to reasons such as upgrading.