

NPN Silicon Darlington Transistor

BC 517

- High current gain
- High collector current
- Complementary type: BC 516 (PNP)

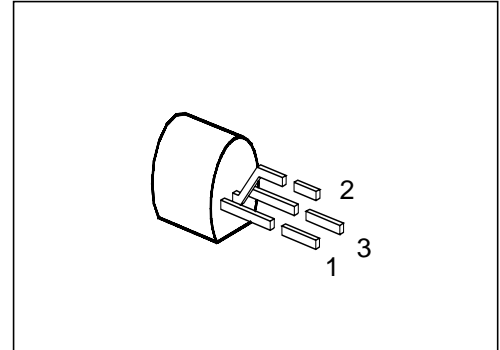

Type	Marking	Ordering Code	Pin Configuration			Package ¹⁾
			1	2	3	
BC 517	–	Q62702-C825	C	B	E	TO-92

Maximum Ratings

Parameter	Symbol	Values	Unit
Collector-emitter voltage	V_{CE0}	30	V
Collector-base voltage	V_{CB0}	40	
Emitter-base voltage	V_{EB0}	10	
Collector current	I_C	500	mA
Peak collector current	I_{CM}	800	
Base current	I_B	100	
Peak base current	I_{BM}	200	
Total power dissipation, $T_c = 66\text{ °C}$	P_{tot}	625	mW
Junction temperature	T_j	150	°C
Storage temperature range	T_{stg}	– 65 ... + 150	

Thermal Resistance

Junction - ambient	$R_{th\ JA}$	≤ 200	K/W
Junction - case ²⁾	$R_{th\ JC}$	≤ 135	

¹⁾ For detailed information see chapter Package Outlines.

²⁾ Mounted on Al heat sink 15 mm × 25 mm × 0.5 mm.

Electrical Characteristics

at $T_A = 25\text{ °C}$, unless otherwise specified.

Parameter	Symbol	Values			Unit
		min.	typ.	max.	

DC characteristics

Collector-emitter breakdown voltage $I_C = 10\text{ mA}$	$V_{(BR)CE0}$	30	–	–	V
Collector-base breakdown voltage $I_C = 100\text{ }\mu\text{A}$	$V_{(BR)CB0}$	40	–	–	
Emitter-base breakdown voltage $I_E = 10\text{ }\mu\text{A}$	$V_{(BR)EB0}$	10	–	–	
Collector cutoff current $V_{CB} = 30\text{ V}$ $V_{CB} = 30\text{ V}, T_A = 150\text{ °C}$	I_{CB0}	–	–	100 10	nA μA
Emitter cutoff current $V_{EB} = 4\text{ V}$	I_{EB0}	–	–	100	nA
DC current gain $I_C = 20\text{ mA}; V_{CE} = 2\text{ V}^1)$	h_{FE}	30 000	–	–	–
Collector-emitter saturation voltage ¹⁾ $I_C = 100\text{ mA}; I_B = 0.1\text{ mA}$	V_{CEsat}	–	–	1	V
Base-emitter voltage ¹⁾ $I_C = 10\text{ mA}; V_{CE} = 5\text{ V}$	V_{BE}	–	–	1.4	

AC characteristics

Transition frequency $I_C = 50\text{ mA}, V_{CE} = 5\text{ V}, f = 20\text{ MHz}$	f_T	–	150	–	MHz
Output capacitance $V_{CB} = 10\text{ V}, f = 1\text{ MHz}$	C_{obo}	–	3.5	–	pF

¹⁾ Pulse test: $t \leq 300\text{ }\mu\text{s}, D \leq 2\text{ %}$.

Total power dissipation $P_{tot} = f(T_A; T_C)$

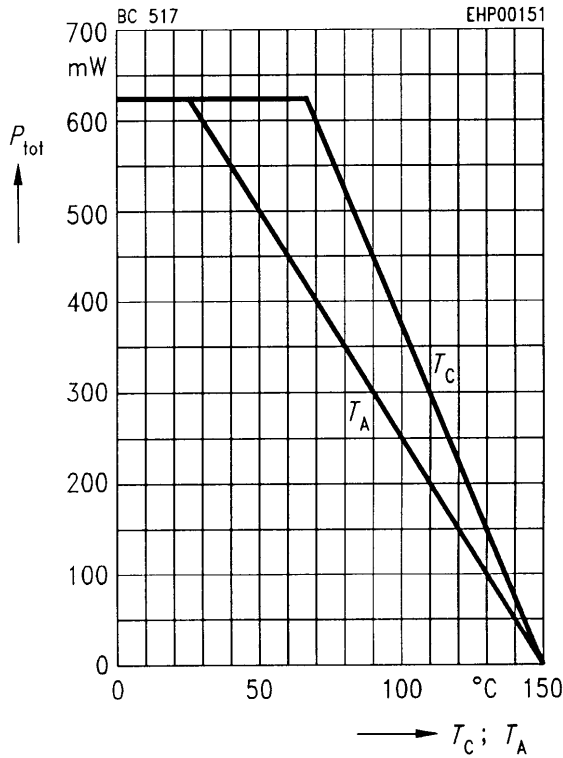

Collector cutoff current $I_{CB0} = f(T_A)$

$V_{CB} = 30 \text{ V}$

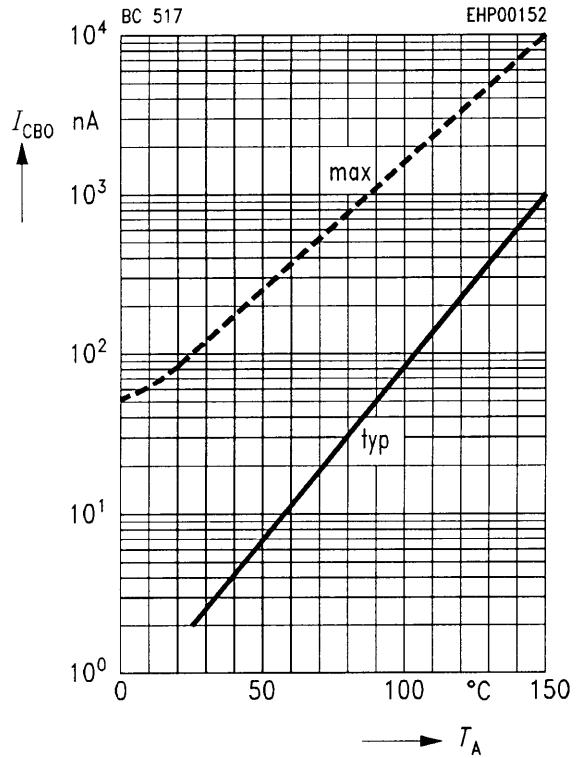

Permissible pulse load $R_{thJA} = f(t_p)$

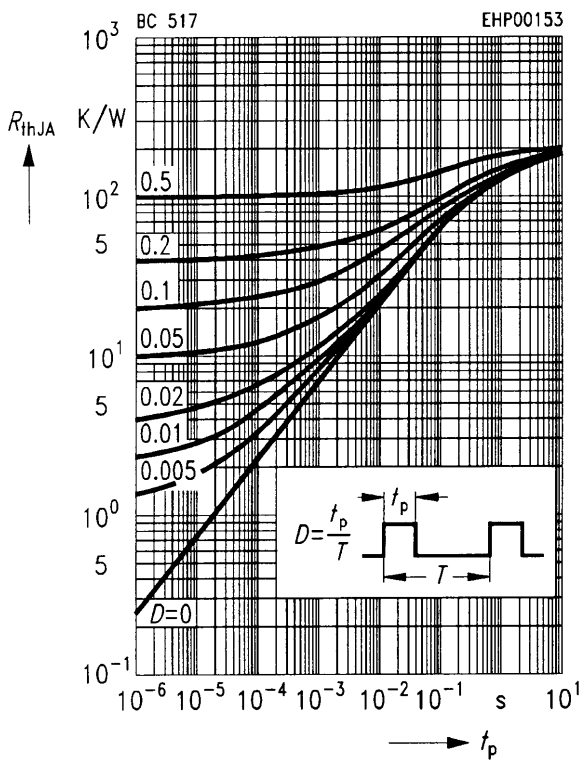

Transition frequency $f_T = f(I_C)$

$V_{CE} = 5 \text{ V}, f = 20 \text{ MHz}$

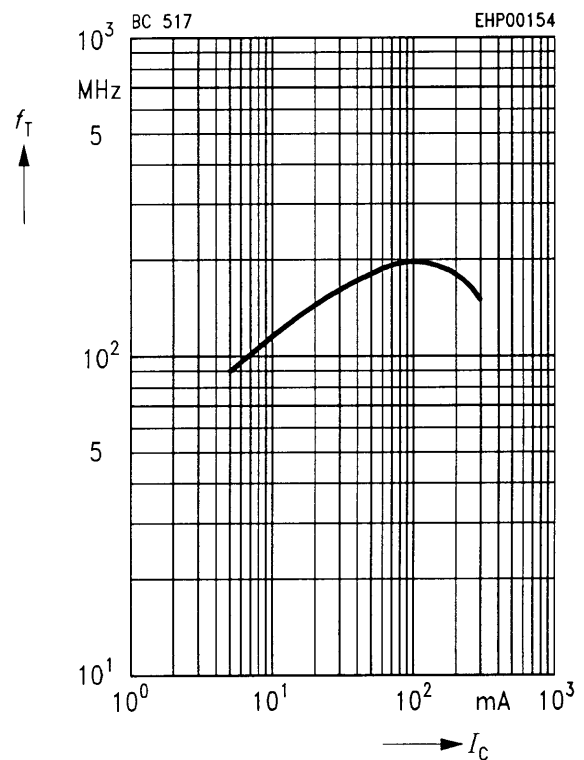

Collector-emitter saturation voltage

$I_C = f(V_{CEsat})$

$h_{FE} = 1000$, parameter = T_A

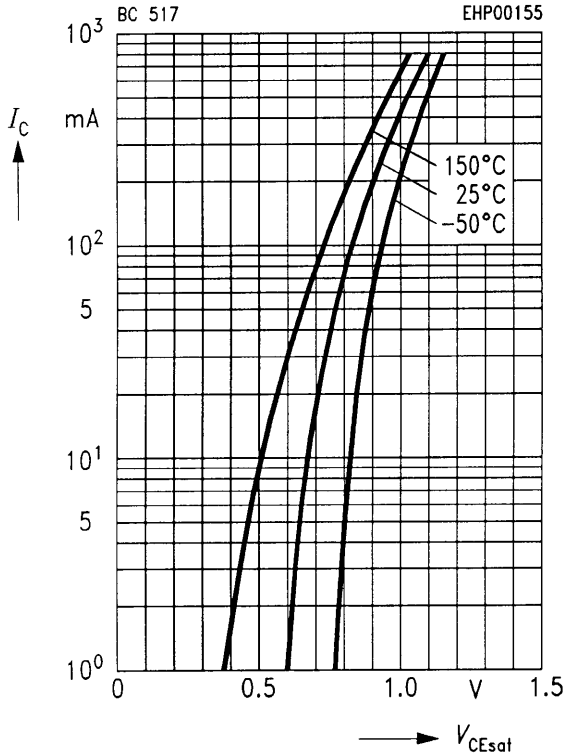

Base-emitter saturation voltage

$I_C = f(V_{BEsat})$

$h_{FE} = 1000$, parameter = T_A

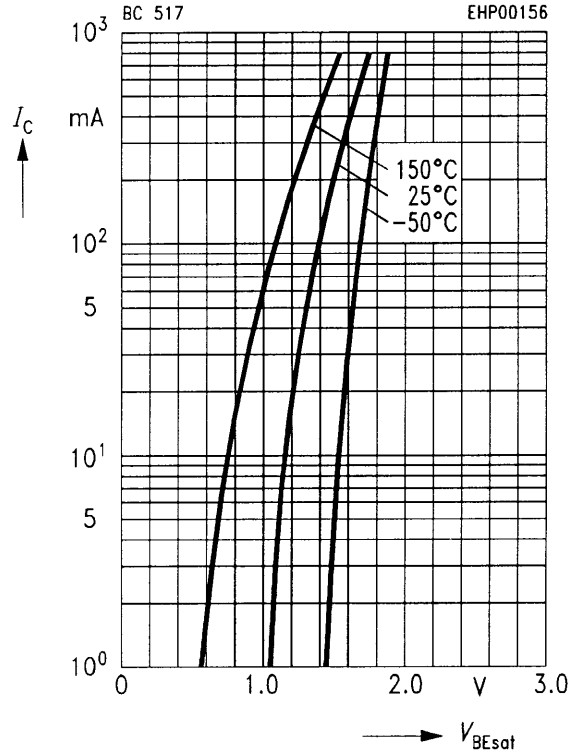

DC current gain $h_{FE} = f(I_C)$

$V_{CE} = 2$ V, parameter = T_A

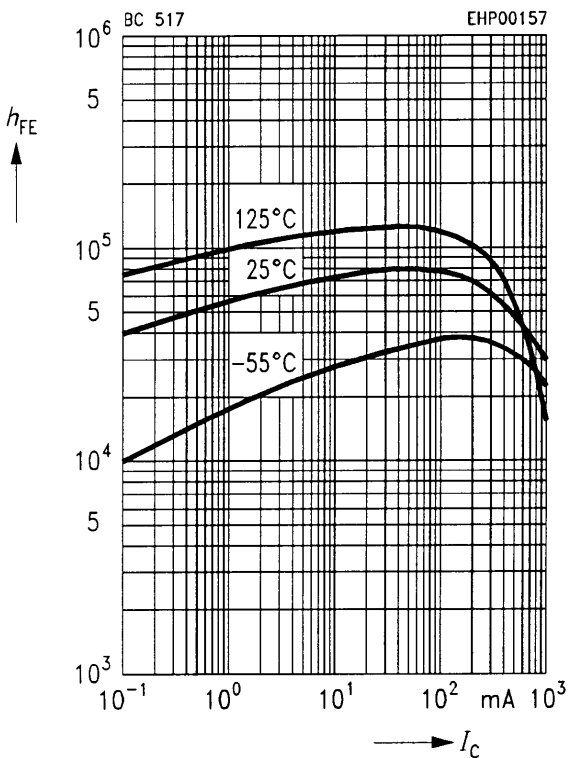

Capacitance $C = f(V_{EB}, V_{CB})$

