

01

0134

DIN circular connectors



DIN plug, angular version, shielded, with bayonet lock, metal housing, bend protection and solder terminals

01

0134

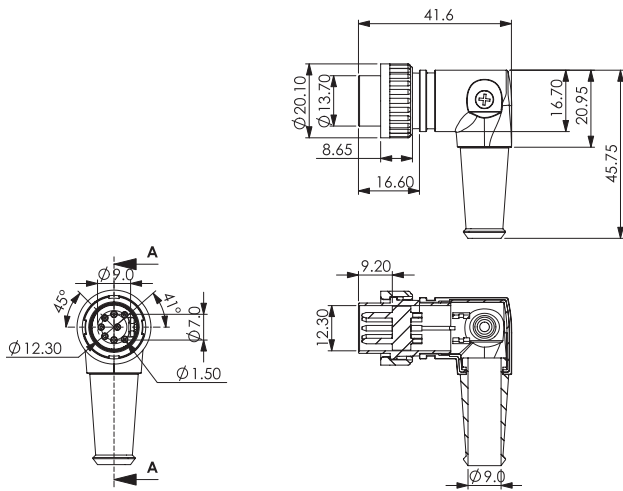

Environmental conditions

Temperature range -20 °C/+85 °C

Materials

Insulating body	ABS+PC, V-0 according to UL94
Contact pin	CuZn, silver-plated
Strain relief	steel, nickel-plated
Housing	Zn alloy, nickel-plated
Bayonet nut	Zn alloy, nickel-plated
Bend protection sleeve	PVC
Screw	steel, nickel-plated

Connectable conductors for solder area

Section	≤ AWG 18 (0,75 mm ²)
Cable diameter	7,0 mm

DIN 41524

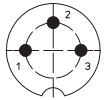

0134 03

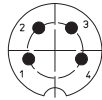

0134 04

DIN 41524

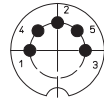

0134 05

DIN 45322

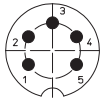

0134 05-1

DIN 45322

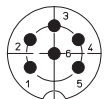

0134 06

DIN 45329

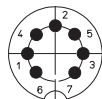

0134 07-1

DIN 45326

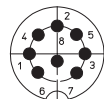



0134 08-1

Electrical data (at T_{amb} 20 °C)

Rated current	≤ 4 A
Rated voltage	60 V AC
Rated impulse voltage	250 V AC RMS/60 s
Insulation resistance	≥ 100 MΩ

Associated products

Counterparts  0107  0122

01

0134

Designation	Pole Number	PU (Pieces)	MDQ (Pieces)
0134 03	3	50	150
0134 04	4	50	150
0134 05	5	50	150
0134 05-1	5	50	150
0134 06	6	50	150
0134 07-1	7	50	150
0134 08-1	8	50	150

Packaging:

in individual plastic bags, in a cardboard box