

3422 HALL-EFFECT, DIRECTION-DETECTION SENSOR

Selection Guide

Part Number	Pb-Free ¹	Packing ²	Mounting	Ambient, T _A (°C)
A3422EKA-T	Yes	Bulk, 500 pieces/bag	5-pin SIP through hole	-40 to 85
A3422LKA-T	Yes	Bulk, 500 pieces/bag	5-pin SIP through hole	-40 to 150

¹Pb-based variants are being phased out of the product line. The variants cited in this footnote are in production but have been determined to be NOT FOR NEW DESIGN. This classification indicates that sale of this device is currently restricted to existing customer applications. The variants should not be purchased for new design applications because obsolescence in the near future is probable. Samples are no longer available. Status change: May 1, 2006. These variants include: A3422EKA and A3422LKA.

²Contact Allegro for additional packing options.

FUNCTIONAL BLOCK DIAGRAM

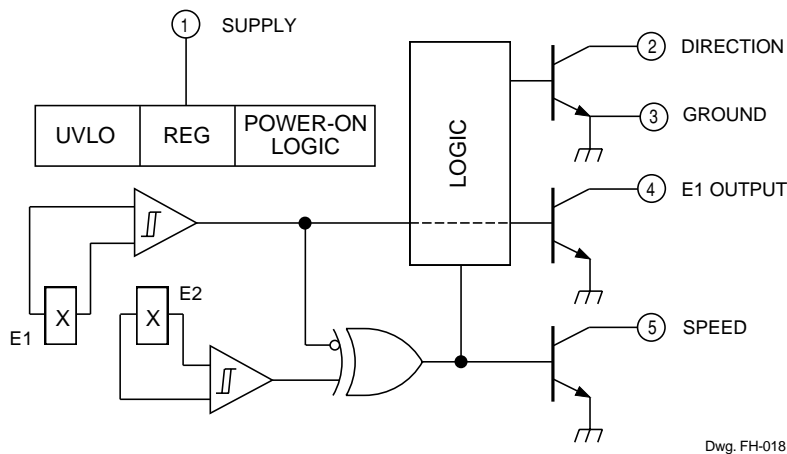

TIMING DIAGRAM

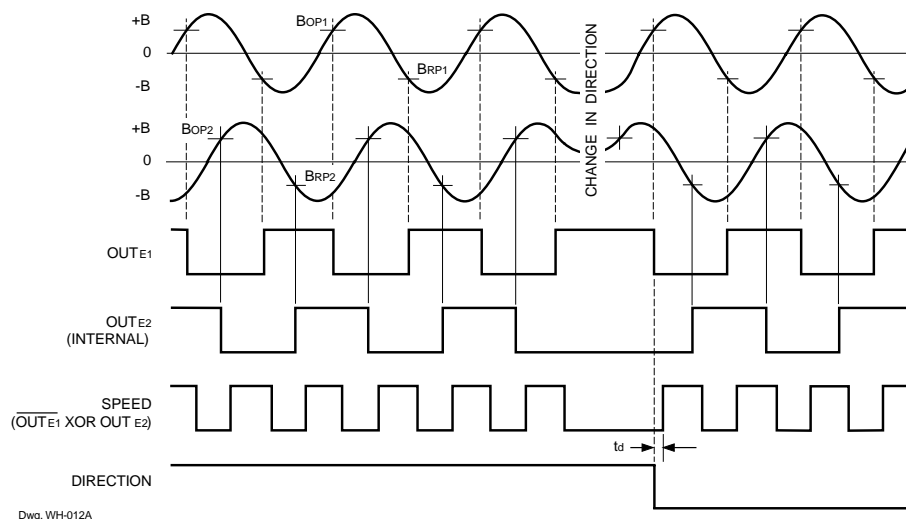

3422 HALL-EFFECT, DIRECTION-DETECTION SENSOR

ELECTRICAL CHARACTERISTICS over operating temperature range.

Characteristic	Symbol	Test Conditions	Limits			Units
			Min.	Typ.	Max.	
Supply Voltage Range	V_{CC}	Operating, $T_J < 165^\circ\text{C}^1$	4.5	—	18	V
Output Leakage Current	I_{OFF}	$V_{OUT} = V_{CC} = 18\text{ V}$	—	<1.0	10	μA
Output Saturation Voltage	$V_{OUT(SAT)}$	$I_{OUT} = 20\text{ mA}$	—	0.21	0.50	V
Power-On State	POS	$V_{CC} = 0 \rightarrow 5\text{ V}$, $B_{RP1} < B < B_{OP1}$, $B_{RP2} < B < B_{OP2}$	OFF	OFF	OFF	—
Undervoltage Lockout	$V_{CC(UV)}$	$I_{OUT} = 20\text{ mA}$, $V_{CC} = 0 \rightarrow 5\text{ V}$	—	3.5	—	V
Undervoltage Hysteresis	$V_{CC(hys)}$	Lockout ($V_{CC(UV)}$) - Shutdown	—	0.5	—	V
Power-On Time	t_{po}	$V_{CC} > 4.5\text{ V}$	—	—	50	μs
Output Rise Time	t_r	$C_L = 20\text{ pF}$, $R_L = 820\ \Omega$	—	200	—	ns
Output Fall Time	t_f	$C_L = 20\text{ pF}$, $R_L = 820\ \Omega$	—	200	—	ns
Direction Change Delay	t_d	$C_L = 20\text{ pF}$, $R_L = 820\ \Omega$	0.5	1.0	5.0	μs
Supply Current	I_{CC}	$V_{CC} = 8\text{ V}$, All outputs OFF	5.0	9.0	18	mA

- NOTES: 1. Maximum supply voltage must be adjusted for power dissipation and ambient temperature.
2. Typical Data is at $V_{CC} = 12\text{ V}$ and $T_A = +25^\circ\text{C}$ and is for design information only.

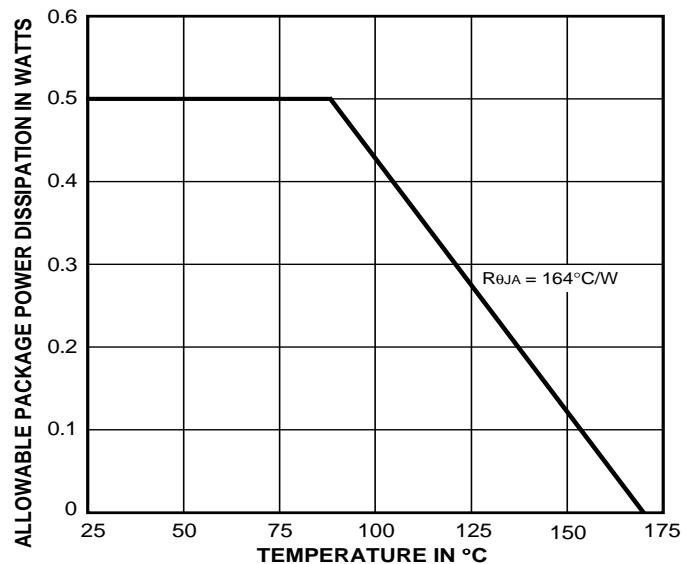

Dwg. GH-069

3422 HALL-EFFECT, DIRECTION-DETECTION SENSOR

MAGNETIC CHARACTERISTICS over operating voltage range.

Characteristic	Symbol	Test Conditions	Limits			
			Min.	Typ.	Max.	Units
Operate Point	B_{OP}	$T_A = -40^\circ\text{C}$	—	—	85	G
		$T_A = +25^\circ\text{C}$	—	29	75	G
		$T_A = \text{Maximum}$	—	—	75	G
Release Point ³	B_{RP}	$T_A = -40^\circ\text{C}$	-85	—	—	G
		$T_A = +25^\circ\text{C}$	-75	-17	—	G
		$T_A = \text{Maximum}$	-75	—	—	G
Hysteresis	B_{hys}	$T_A = -40^\circ\text{C}$	10	—	—	G
		$T_A = +25^\circ\text{C}$	10	46	—	G
		$T_A = \text{Maximum}$	10	—	—	G
Operate Differential	—	$B_{OP1} - B_{OP2}$	—	—	± 60	G
Release Differential	—	$B_{RP1} - B_{RP2}$	—	—	± 60	G

- NOTES: 1. Magnetic flux density is measured at most sensitive area of device, nominally located 0.0165" (0.42 mm) below the branded face of the package.
 2. Typical Data is at $V_{CC} = 12\text{ V}$ and $T_A = +25^\circ\text{C}$ and is for design information only.
 3. As used here, negative flux densities are defined as less than zero (algebraic convention).

Typical Magnetic Characteristics

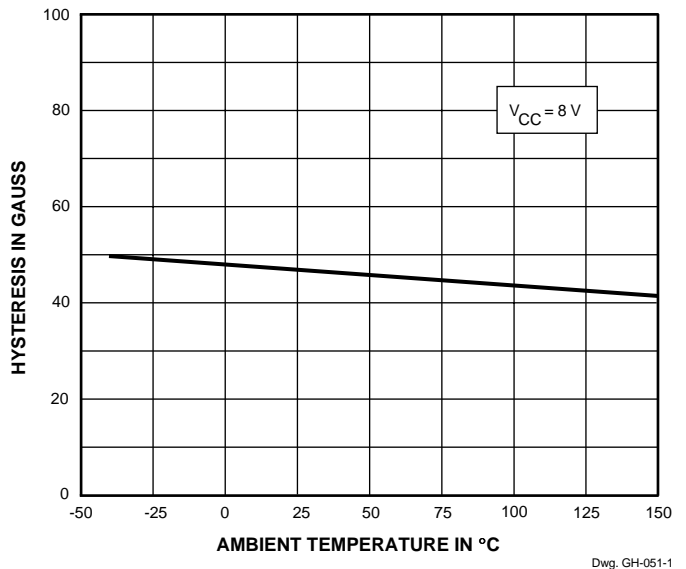
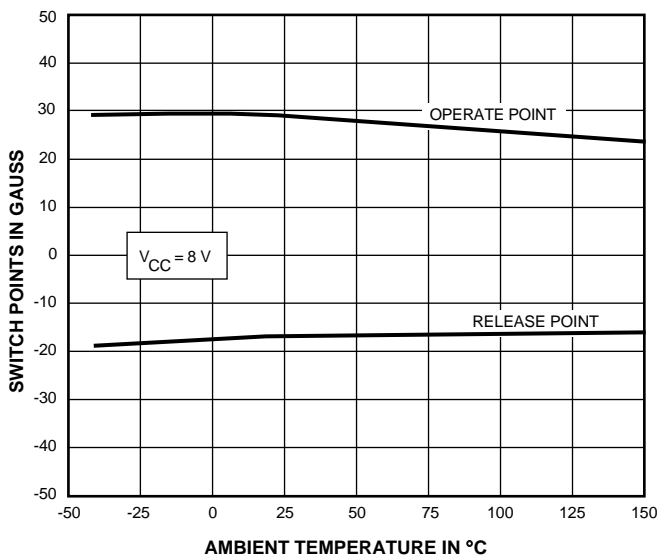

3422 HALL-EFFECT, DIRECTION-DETECTION SENSOR

Typical Electrical Characteristics

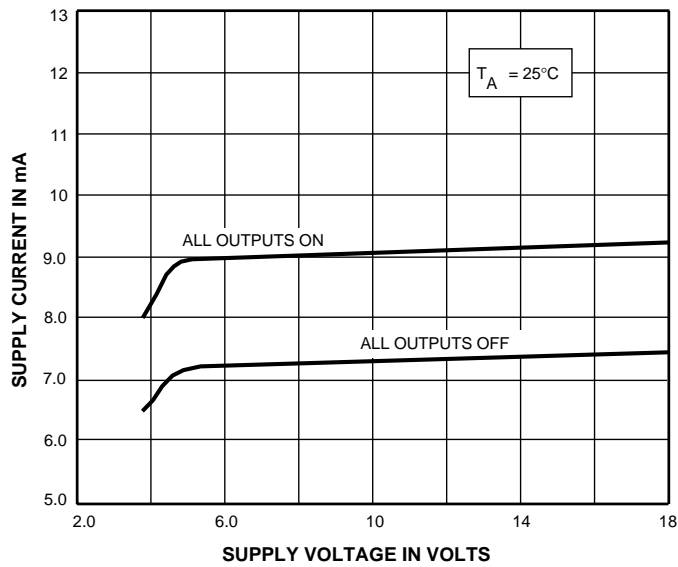
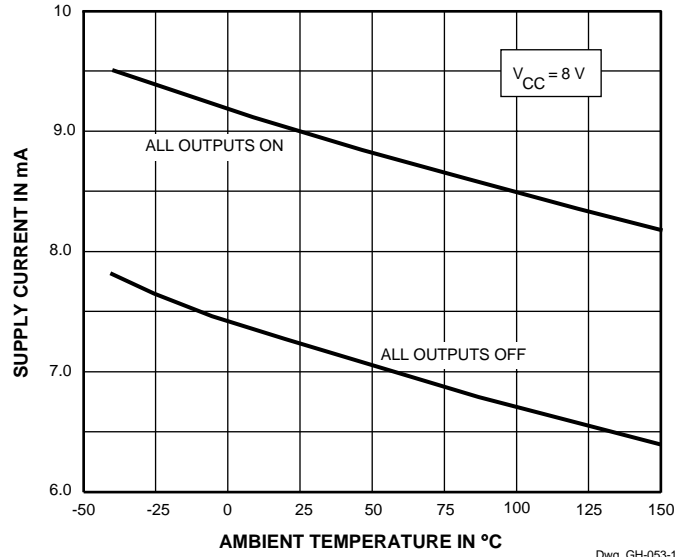
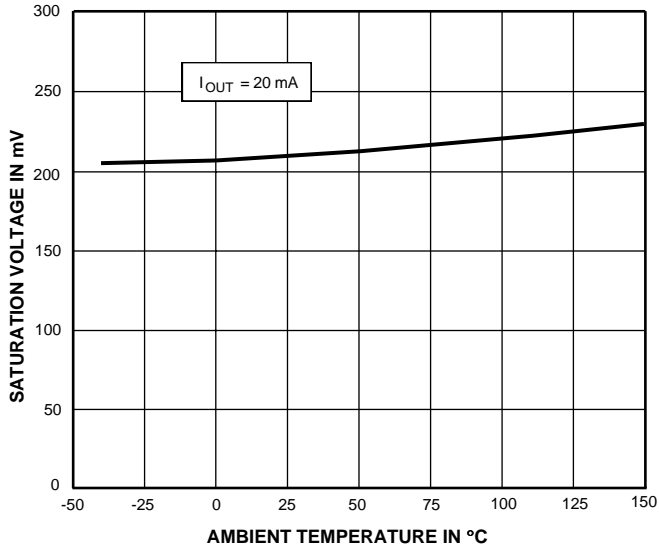

3422 **HALL-EFFECT, DIRECTION-DETECTION SENSOR**

Functional Description

The integrated circuit contains an internal voltage regulator that powers the Hall sensors and both the analog and digital circuitry. This regulator allows operation over a wide supply voltage range and provides some immunity to supply noise. The device also contains CMOS logic circuitry that decodes the direction of rotation of the ring magnet.

Quadrature/Direction Detection. Internal logic circuitry provides outputs representing speed and direction of the magnetic field across the face of the package. For the direction signal to be appropriately updated, a quadrature relationship must be maintained between the ring magnet pole width*, the sensor-to-sensor spacing, and, to a lesser extent, the magnetic switch points. For optimal design, the sensor should be actuated with a ring magnet pole width* two times the sensor-to-sensor spacing. This will produce a sinusoidal magnetic field whose period (denoted as T) is then four times the sensor-to-sensor spacing. A quadrature relationship can also be maintained for a ring magnet that has a period that satisfies the relationship $nT/4 = 1.5 \text{ mm}$, where n is any odd integer. Therefore, ring magnets with pole-pair spacing equal to 6 mm ($n = 1$), 2 mm ($n = 3$), 1.2 mm ($n = 5$), etc. are permitted.

The response of the device to the magnetic field produced by a rotating ring magnet is shown on page 2. Note the phase shift between the two integrated sensors.

Outputs. The device provides three saturated outputs: DIRECTION, E1 OUTPUT, and SPEED. DIRECTION provides the direction output of the sensor and is defined as OFF (high) for the direction E1 to E2 and ON (low) for the direction E2 to E1. SPEED provides an XOR'd output of the two sensors. Because of internal delays, DIRECTION will always be updated before SPEED and is updated at every transition of E1 OUTPUT and E2 OUTPUT (internal) allowing the use of up-down counters without the loss of pulses.

Power-On State. At power on, the logic circuitry is reset to provide an OFF (high) at DIRECTION and an OFF (high) for E1 and E2 (internal) for magnetic fields less than B_{OP} . This eliminates ambiguity when the device is powered up and either sensor detects a field between B_{OP} and B_{RP} . If either sensor is subjected to a field greater than B_{OP} , the internal logic will set accordingly.

* "Pole" refers to a single pole (North or South) unless stated as "pole pair" (North and South).

Applications Information

Operation with Fine-Pitch Ring Magnets. For targets with a circular pitch of less than 4 mm, a performance improvement can be observed by rotating the front face of the sensor subassembly (see below). This sensor rotation decreases the effective sensor-to-sensor spacing, provided that the Hall elements are not rotated beyond the width of the target.

Applications. It is strongly recommended that an external 0.01 μ F bypass capacitor be connected (in close proximity to the Hall sensor) between the supply and ground of the device to reduce both external noise and noise generated by the internal logic.

The simplest form of magnet that will operate these devices is a ring magnet. Other methods of operation, such as linear magnets, are possible. Extensive applications information on magnets and Hall-effect sensors is also available in the “Hall-Effect IC Applications Guide” which can be found in the latest issue of *Application Note 27701*, at

www.allegromicro.com/techpub2/an/an27701

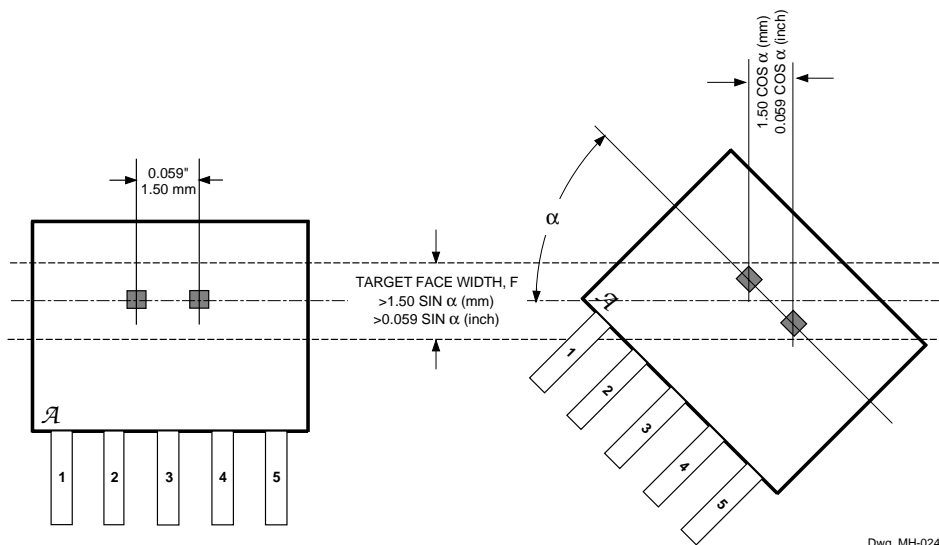

**Rotated Sensor for
Fine-Pitch Ring
Magnets**

3422
HALL-EFFECT,
DIRECTION-DETECTION
SENSOR

Criteria for Device Qualification

Contact Allegro MicroSystems for qualification information.

Sensor Locations

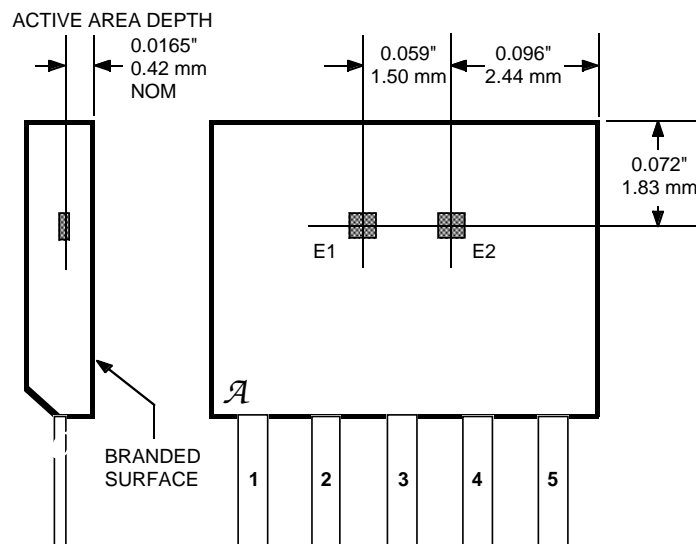

Dwg. MH-007-1A

3422 HALL-EFFECT, DIRECTION-DETECTION SENSOR

Package Designator 'KA'

Dimensions in Inches (controlling dimensions)

Dimensions in Millimeters (for reference only)

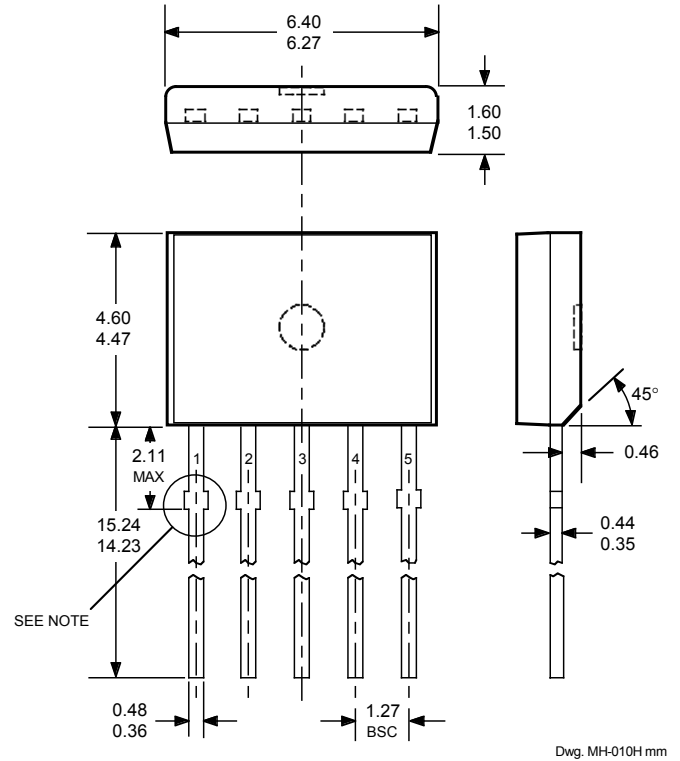
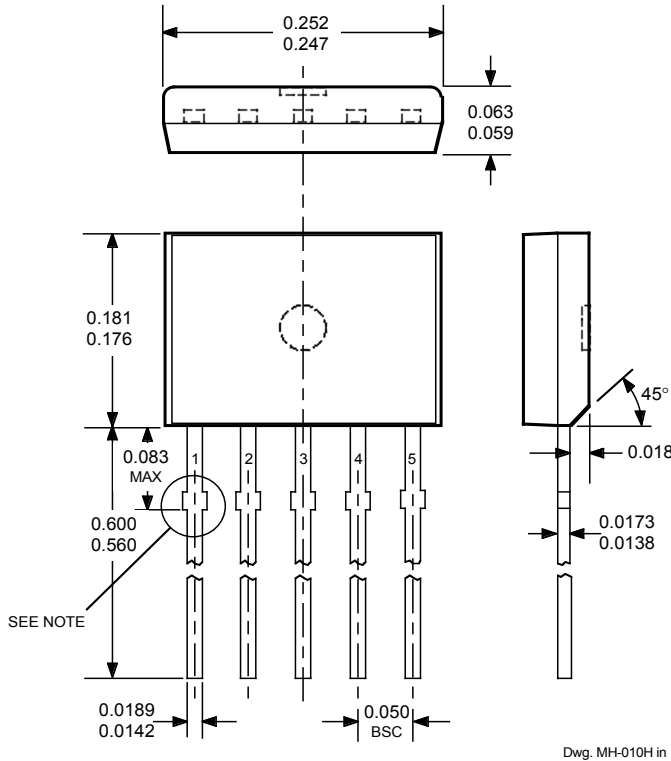

Horizontal-Mount Lead Form (add '-TL' to part number)

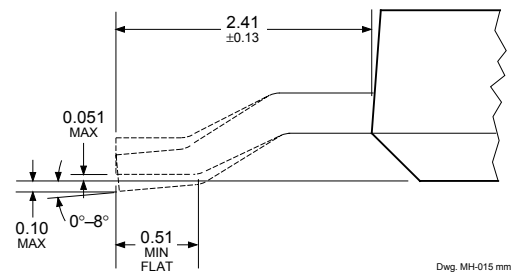
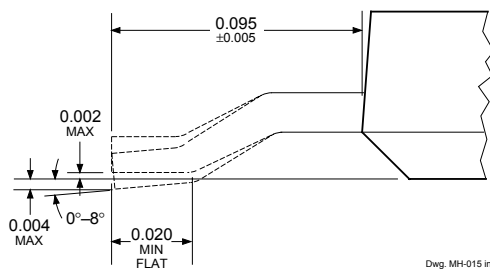

- NOTES:
1. Tolerances on package height and width represent allowable mold offsets. Dimensions given are measured at the widest point (parting line).
 2. Exact body and lead configuration at vendor's option within limits shown.
 3. Height does not include mold gate flash.
 4. Recommended minimum PWB hole diameter to clear transition area is 0.035" (0.89 mm).
 5. Where no tolerance is specified, dimension is nominal.
 6. Supplied in bulk pack (500 pieces per bag).

3422
HALL-EFFECT,
DIRECTION-DETECTION
SENSOR

The products described herein are manufactured under one or more of the following U.S. patents: 5,045,920; 5,264,783; 5,442,283; 5,389,889; 5,581,179; 5,517,112; 5,619,137; 5,621,319; 5,650,719; 5,686,894; 5,694,038; 5,729,130; 5,917,320; and other patents pending.

Allegro MicroSystems, Inc. reserves the right to make, from time to time, such departures from the detail specifications as may be required to permit improvements in the performance, reliability, or manufacturability of its products. Before placing an order, the user is cautioned to verify that the information being relied upon is current.

Allegro products are not authorized for use as critical components in life-support appliances, devices, or systems without express written approval.

The information included herein is believed to be accurate and reliable. However, Allegro MicroSystems, Inc. assumes no responsibility for its use; nor for any infringements of patents or other rights of third parties that may result from its use.