

IRG4PC50UPbF

INSULATED GATE BIPOLAR TRANSISTOR

UltraFast Speed IGBT

Features

- UltraFast: Optimized for high operating frequencies 8-40 kHz in hard switching, >200 kHz in resonant mode
- Generation 4 IGBT design provides tighter parameter distribution and higher efficiency than Generation 3
- Industry standard TO-247AC package
- Lead-Free

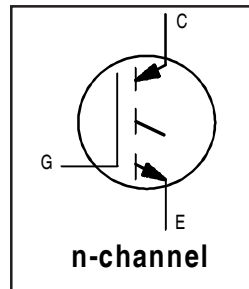

$V_{CES} = 600V$
$V_{CE(on) typ.} = 1.65V$
@ $V_{GE} = 15V, I_C = 27A$

Benefits

- Generation 4 IGBT's offer highest efficiency available
- IGBT's optimized for specified application conditions
- Designed to be a "drop-in" replacement for equivalent industry-standard Generation 3 IR IGBT's

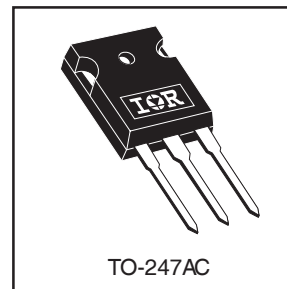

Absolute Maximum Ratings

	Parameter	Max.	Units
V_{CES}	Collector-to-Emitter Breakdown Voltage	600	V
$I_C @ T_C = 25^\circ C$	Continuous Collector Current	55	A
$I_C @ T_C = 100^\circ C$	Continuous Collector Current	27	
I_{CM}	Pulsed Collector Current ①	220	
I_{LM}	Clamped Inductive Load Current ②	220	
V_{GE}	Gate-to-Emitter Voltage	± 20	V
E_{ARV}	Reverse Voltage Avalanche Energy ③	20	mJ
$P_D @ T_C = 25^\circ C$	Maximum Power Dissipation	200	W
$P_D @ T_C = 100^\circ C$	Maximum Power Dissipation	78	
T_J	Operating Junction and Storage Temperature Range	-55 to + 150	°C
T_{STG}			
	Mounting torque, 6-32 or M3 screw.	10 lbf•in (1.1N•m)	

Thermal Resistance

	Parameter	Typ.	Max.	Units
$R_{\theta JC}$	Junction-to-Case	----	0.64	°C/W
$R_{\theta CS}$	Case-to-Sink, Flat, Greased Surface	0.24	----	
$R_{\theta JA}$	Junction-to-Ambient, typical socket mount	----	40	
Wt	Weight	6 (0.21)	----	

Electrical Characteristics @ $T_J = 25^\circ\text{C}$ (unless otherwise specified)

	Parameter	Min.	Typ.	Max.	Units	Conditions
$V_{(BR)CES}$	Collector-to-Emitter Breakdown Voltage	600	----	----	V	$V_{GE} = 0V, I_C = 250\mu A$
$V_{(BR)ECS}$	Emitter-to-Collector Breakdown Voltage ④	18	----	----	V	$V_{GE} = 0V, I_C = 1.0A$
$\Delta V_{(BR)CES}/\Delta T_J$	Temperature Coeff. of Breakdown Voltage	----	0.60	----	V/°C	$V_{GE} = 0V, I_C = 1.0mA$
$V_{CE(ON)}$	Collector-to-Emitter Saturation Voltage	----	1.65	2.0	V	$I_C = 27A$ $I_C = 55A$ $I_C = 27A, T_J = 150^\circ\text{C}$ $V_{GE} = 15V$ See Fig.2, 5
		----	2.0	----		
		----	1.6	----		
$V_{GE(th)}$	Gate Threshold Voltage	3.0	----	6.0		$V_{CE} = V_{GE}, I_C = 250\mu A$
$\Delta V_{GE(th)}/\Delta T_J$	Temperature Coeff. of Threshold Voltage	----	-13	----	mV/°C	$V_{CE} = V_{GE}, I_C = 250\mu A$
g_{fe}	Forward Transconductance ⑤	16	24	----	S	$V_{CE} \geq 15V, I_C = 27A$
I_{CES}	Zero Gate Voltage Collector Current	----	----	250	μA	$V_{GE} = 0V, V_{CE} = 600V$
		----	----	2.0		$V_{GE} = 0V, V_{CE} = 10V, T_J = 25^\circ\text{C}$
		----	----	5000		$V_{GE} = 0V, V_{CE} = 600V, T_J = 150^\circ\text{C}$
I_{GES}	Gate-to-Emitter Leakage Current	----	----	± 100	nA	$V_{GE} = \pm 20V$

Switching Characteristics @ $T_J = 25^\circ\text{C}$ (unless otherwise specified)

	Parameter	Min.	Typ.	Max.	Units	Conditions
Q_g	Total Gate Charge (turn-on)	----	180	270	nC	$I_C = 27A$ $V_{CC} = 400V$ $V_{GE} = 15V$ See Fig. 8
Q_{ge}	Gate - Emitter Charge (turn-on)	----	25	38		
Q_{gc}	Gate - Collector Charge (turn-on)	----	61	90		
$t_{d(on)}$	Turn-On Delay Time	----	32	----	ns	$T_J = 25^\circ\text{C}$ $I_C = 27A, V_{CC} = 480V$ $V_{GE} = 15V, R_G = 5.0\Omega$ Energy losses include "tail" See Fig. 10, 11, 13, 14
t_r	Rise Time	----	20	----		
$t_{d(off)}$	Turn-Off Delay Time	----	170	260		
t_f	Fall Time	----	88	130		
E_{on}	Turn-On Switching Loss	----	0.12	----	mJ	See Fig. 10, 11, 13, 14
E_{off}	Turn-Off Switching Loss	----	0.54	----		
E_{ts}	Total Switching Loss	----	0.66	0.9		
$t_{d(on)}$	Turn-On Delay Time	----	31	----	ns	$T_J = 150^\circ\text{C}$, $I_C = 27A, V_{CC} = 480V$ $V_{GE} = 15V, R_G = 5.0\Omega$ Energy losses include "tail" See Fig. 13, 14
t_r	Rise Time	----	23	----		
$t_{d(off)}$	Turn-Off Delay Time	----	230	----		
t_f	Fall Time	----	120	----		
E_{ts}	Total Switching Loss	----	1.6	----	mJ	
L_E	Internal Emitter Inductance	----	13	----	nH	Measured 5mm from package
C_{ies}	Input Capacitance	----	4000	----	pF	$V_{GE} = 0V$ $V_{CC} = 30V$ $f = 1.0MHz$ See Fig. 7
C_{oes}	Output Capacitance	----	250	----		
C_{res}	Reverse Transfer Capacitance	----	52	----		

Notes:

- ① Repetitive rating; $V_{GE} = 20V$, pulse width limited by max. junction temperature. (See fig. 13b)
- ② $V_{CC} = 80\%(V_{CES}), V_{GE} = 20V, L = 10\mu H, R_G = 5.0\Omega$, (See fig. 13a)
- ③ Repetitive rating; pulse width limited by maximum junction temperature.
- ④ Pulse width $\leq 80\mu s$; duty factor $\leq 0.1\%$.
- ⑤ Pulse width $5.0\mu s$, single shot.

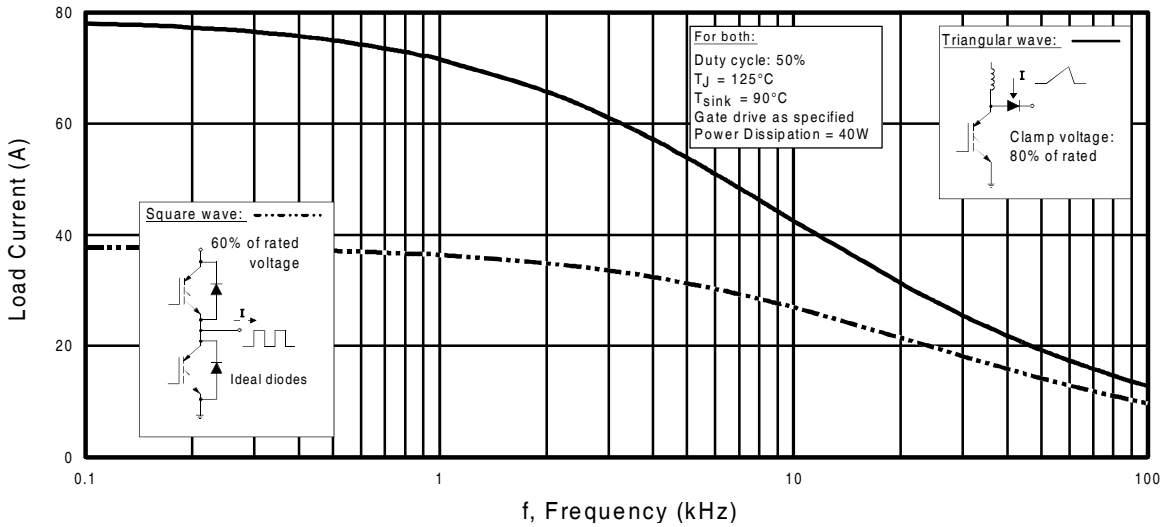

Fig. 1 - Typical Load Current vs. Frequency
(For square wave, $I = I_{RMS}$ of fundamental; for triangular wave, $I = I_{PK}$)

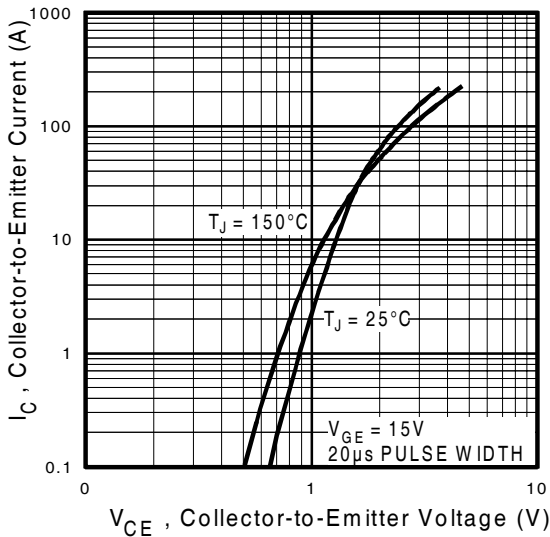

Fig. 2 - Typical Output Characteristics

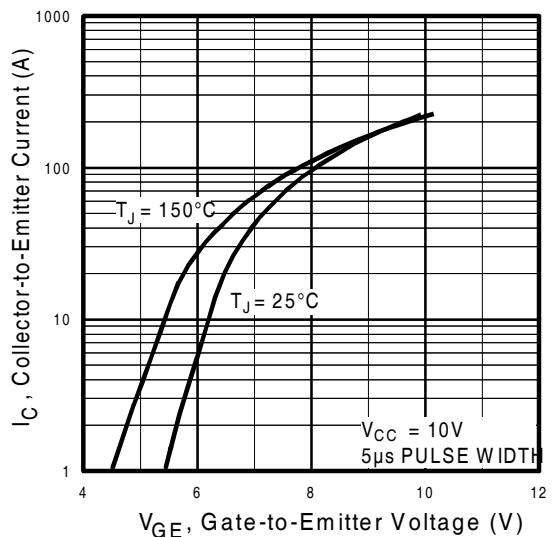

Fig. 3 - Typical Transfer Characteristics

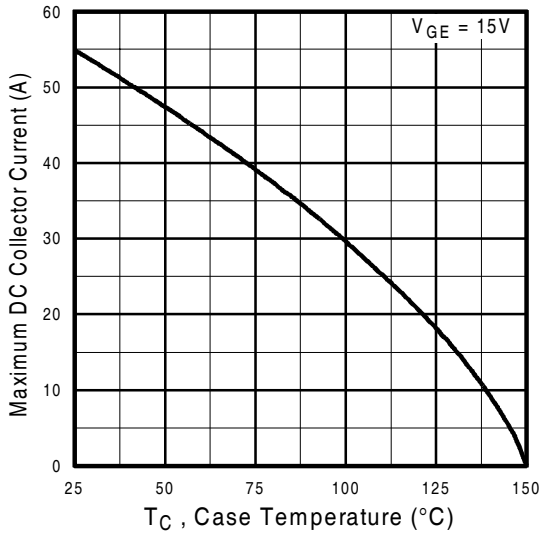

Fig. 4 - Maximum Collector Current vs. Case Temperature

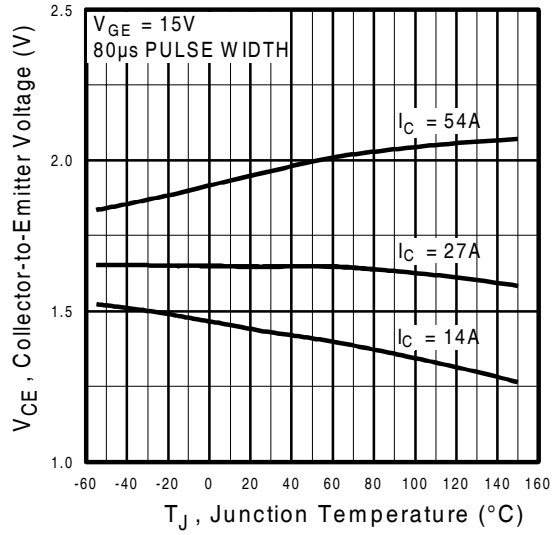

Fig. 5 - Collector-to-Emitter Voltage vs. Junction Temperature

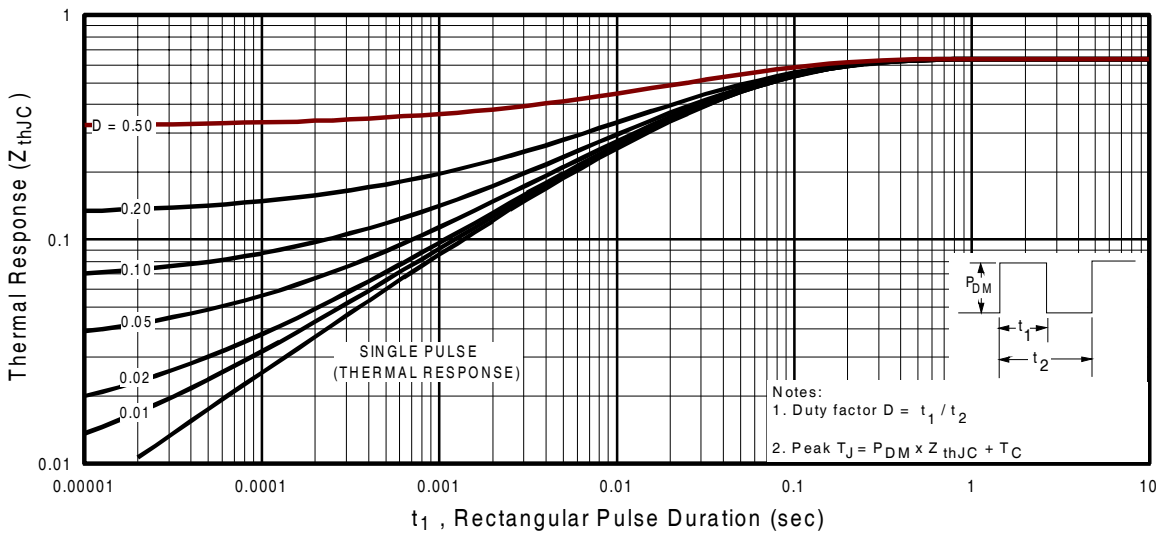

Fig. 6 - Maximum Effective Transient Thermal Impedance, Junction-to-Case

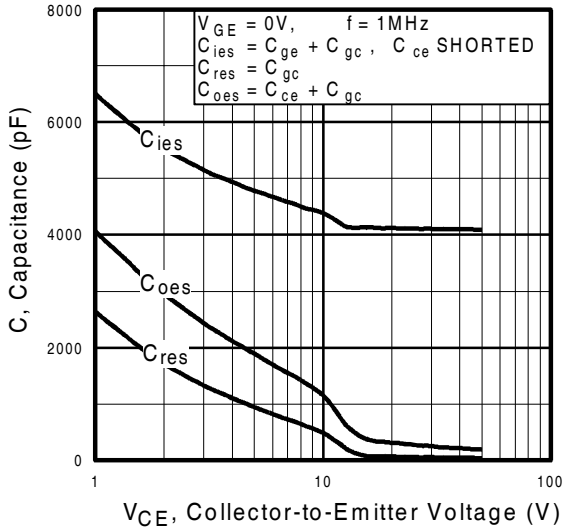

Fig. 7 - Typical Capacitance vs. Collector-to-Emitter Voltage

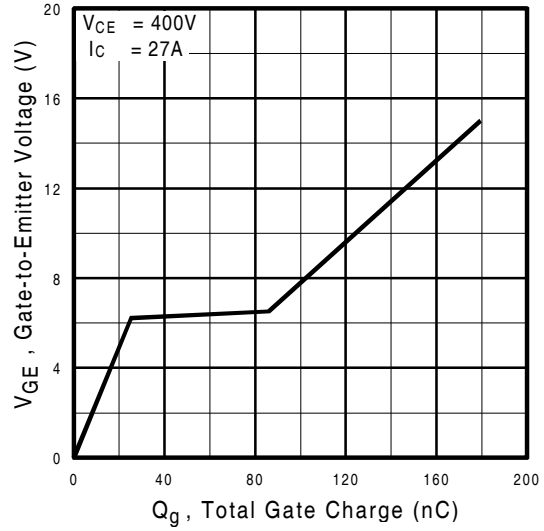

Fig. 8 - Typical Gate Charge vs. Gate-to-Emitter Voltage

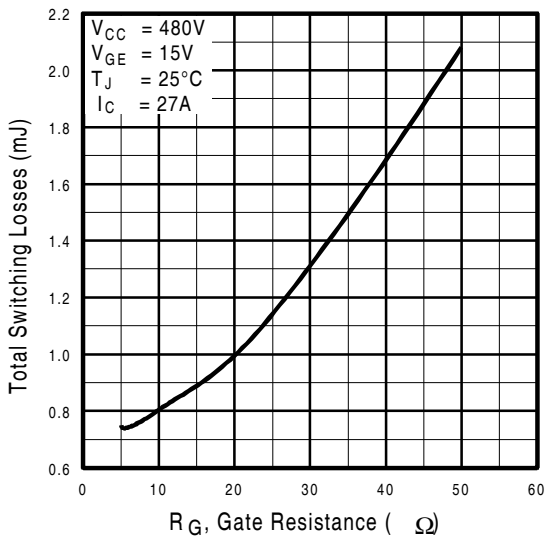

Fig. 9 - Typical Switching Losses vs. Gate Resistance

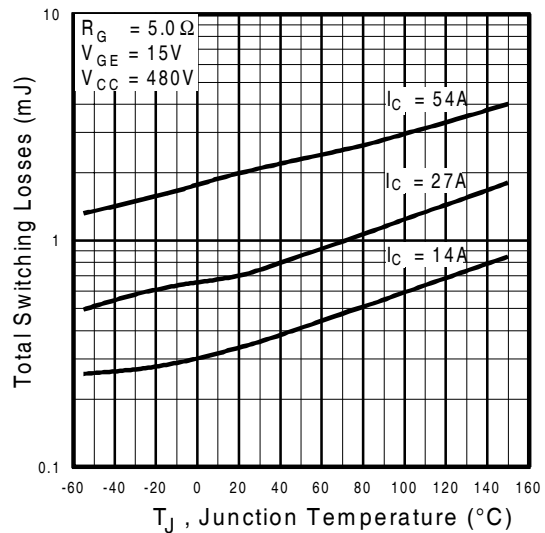

Fig. 10 - Typical Switching Losses vs. Junction Temperature

IRG4PC50UPbF

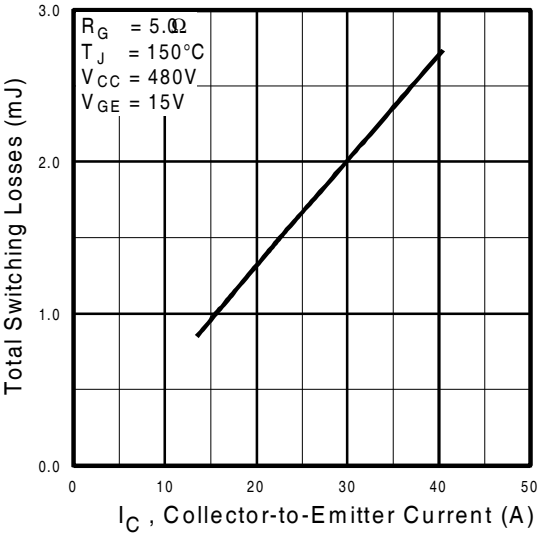

Fig. 11 - Typical Switching Losses vs. Collector-to-Emitter Current

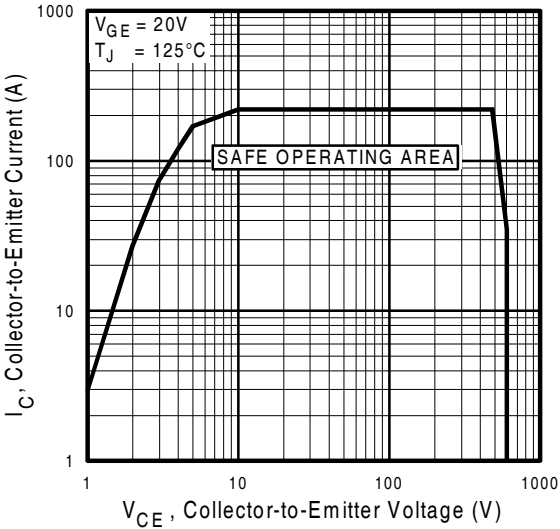
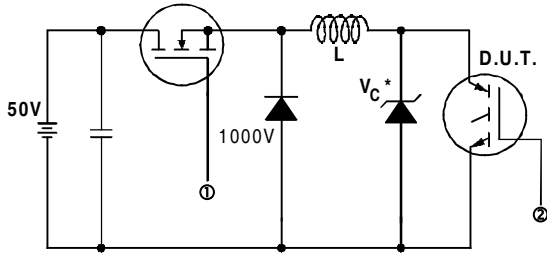

Fig. 12 - Turn-Off SOA



* Driver same type as D.U.T.; $V_c = 80\%$ of $V_{ce(max)}$
 * Note: Due to the 50V power supply, pulse width and inductor will increase to obtain rated I_d .

Fig. 13a - Clamped Inductive Load Test Circuit

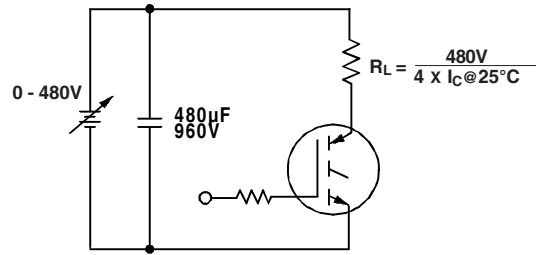

Fig. 13b - Pulsed Collector Current Test Circuit

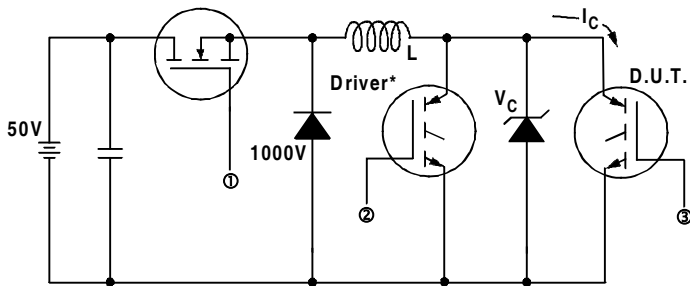

Fig. 14a - Switching Loss Test Circuit

* Driver same type as D.U.T., $V_C = 480V$

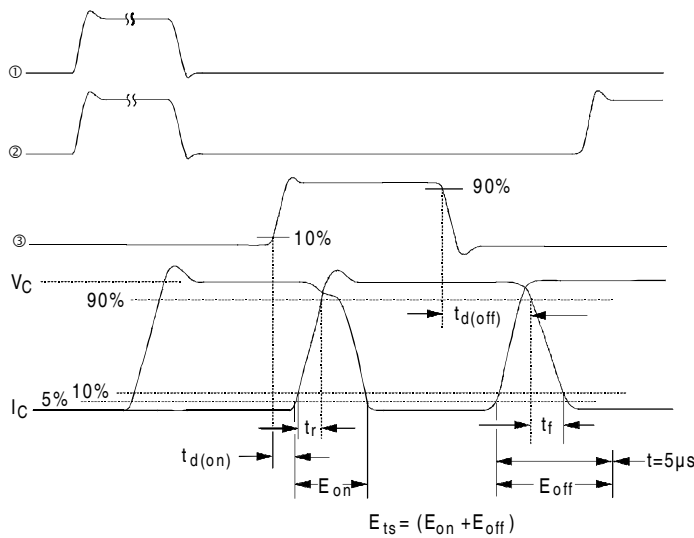

Fig. 14b - Switching Loss Waveforms

IRG4PC50UPbF

International
IR Rectifier

TO-247AC Package Outline

Dimensions are shown in millimeters (inches)

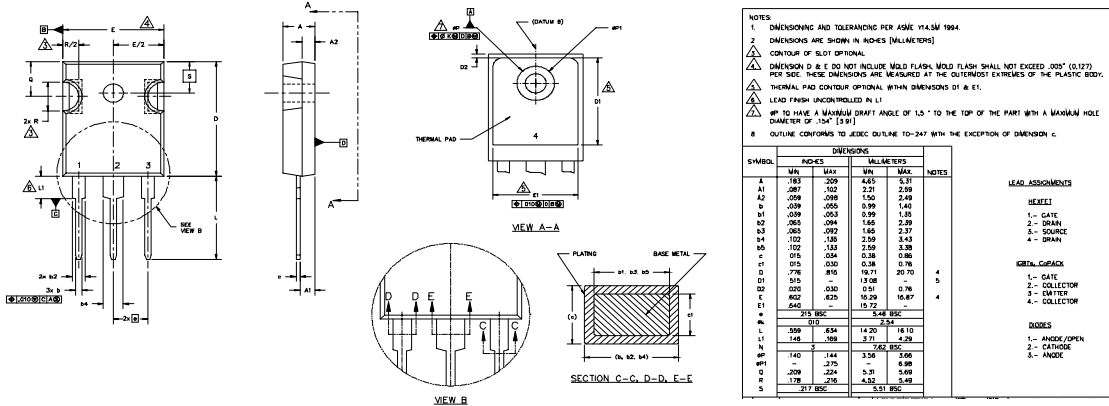

TO-247AC Part Marking Information

EXAMPLE: THIS IS AN IRFP30
WITH ASSEMBLY
LOT CODE 5657
ASSEMBLED ON WW 35, 2000
IN THE ASSEMBLY LINE "H"

Note: "P" in assembly line
position indicates "Lead-Free"

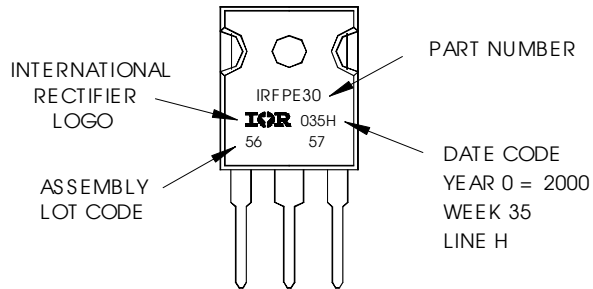

International
IR Rectifier

IR WORLD HEADQUARTERS: 233 Kansas St., El Segundo, California 90245, USA Tel: (310) 252-7105
TAC Fax: (310) 252-7903

Visit us at www.irf.com for sales contact information.
Data and specifications subject to change without notice. 04/04

Note: For the most current drawings please refer to the IR website at:
<http://www.irf.com/package/>