

High IP3 Frequency Mixer

MCA-30FLH+

Level 10 LO Power+10 dBm 2960 to 3060 MHz



CASE STYLE: DZ883

Maximum Ratings

Operating Temperature	-55°C to 100°C
Storage Temperature	-55°C to 100°C
LO & RF Power	16 dBm

Permanent damage may occur if any of these limits are exceeded.

Pin Connections

LO	10
RF	5
IF	3
GROUND	1,2,4,6,7,8,9

Features

- high IP3, 25 dBm typ.
- good L-R isolation, 35 dB typ.
- excellent 1 dB compression, RF>LO power
- industry standard foot print
- LTCC design for excellent temperature stability performance repeatability and small size
- aqueous washable
- double balanced mixer
- low price
- protected by US Patent 6,959,180

Applications

- line of sight links
- satellite communications

+RoHS Compliant
The +Suffix identifies RoHS Compliance. See our web site for RoHS Compliance methodologies and qualifications

Available Tape and Reel at no extra cost

Reel Size	Devices/Reel
7"	10, 20, 50, 100, 200
13"	500,1000

Outline Drawing

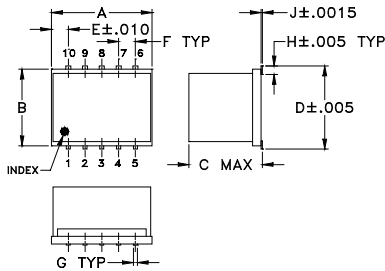

PCB Land Pattern

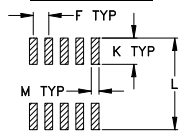

Suggested L layout,
Tolerance to be within ±.002

Outline Dimensions (inch/mm)

A	B	C	D	E	F	G
.30	.250	.190	.266	.050	.050	.012
7.62	6.35	4.83	6.76	1.27	1.27	0.30
H	J	K	L	M	wt	
.029	.004	.085	.296	.030	grams	
0.74	0.10	2.16	7.52	0.76	0.5	

Electrical Specifications (T_{AMB}=-55°C to 100°C)

FREQUENCY (MHz)			IP3 (dBm)	RF in at 1 dB compr. (dBm)	CONVERSION LOSS (dB)		LO-RF ISOLATION (dB)		LO-IF ISOLATION (dB)	
RF	LO	IF	Typ.	Min.	Typ.	Max.	Typ.	Min.	Typ.	Min.
2960-3060	2780-2880	130-230	25	10	7.5	8.9	35	20	27	15

Typical Performance Data

Frequency (MHz)		Conversion Loss (dB)	Isolation L-R (dB)	Isolation L-I (dB)	VSWR RF Port (:1)	VSWR LO Port (:1)	IP3 (dBm)
RF	LO	LO +10dBm	LO +10dBm	LO +10dBm	LO +10dBm	LO +10dBm	LO +10dBm
2960.00	2780.00	7.53	34.71	30.54	1.64	2.97	25.90
2970.00	2790.00	7.51	34.88	30.65	1.66	2.79	26.46
2980.00	2800.00	7.45	35.01	30.70	1.68	2.81	27.12
2990.00	2810.00	7.44	35.02	30.73	1.73	2.89	27.55
3000.00	2820.00	7.45	34.99	30.81	1.79	2.94	27.65
3010.00	2830.00	7.48	35.10	30.95	1.85	2.85	27.40
3020.00	2840.00	7.52	35.30	31.22	1.88	2.66	26.70
3030.00	2850.00	7.56	35.48	31.48	1.91	2.46	26.27
3040.00	2860.00	7.57	35.66	31.70	1.93	2.32	26.09
3050.00	2870.00	7.57	35.88	31.95	1.95	2.31	26.24
3060.00	2880.00	7.56	36.21	32.10	1.97	2.45	26.56

Demo Board MCL P/N: TB-144 Suggested PCB Layout (PL-045)

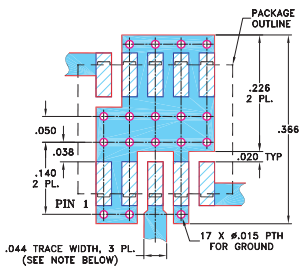

- NOTES: 1. TRACE WIDTH IS SHOWN FOR ROGERS RO4350B WITH DIELECTRIC THICKNESS .020" ± .0015"; COPPER: 1/2 OZ. EACH SIDE. FOR OTHER MATERIALS TRACE WIDTH MAY NEED TO BE MODIFIED.
2. BOTTOM SIDE OF THE PCB IS CONTINUOUS GROUND PLANE.
- DENOTES PCB COPPER LAYOUT WITH SMOBC (SOLDER MASK OVER BARE COPPER)
 - DENOTES COPPER LAND PATTERN FREE OF SOLDER MASK
- Notes

Electrical Schematic

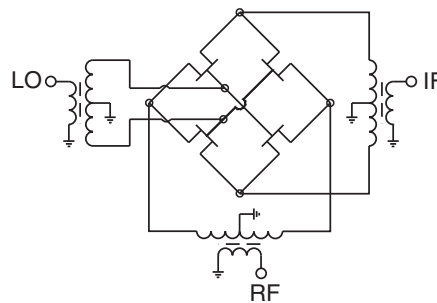

A. Performance and quality attributes and conditions not expressly stated in this specification document are intended to be excluded and do not form a part of this specification document.
B. Electrical specifications and performance data contained in this specification document are based on Mini-Circuit's applicable established test performance criteria and measurement instructions.
C. The parts covered by this specification document are subject to Mini-Circuit's standard limited warranty and terms and conditions (collectively, "Standard Terms"); Purchasers of this part are entitled to the rights and benefits contained therein. For a full statement of the Standard Terms and the exclusive rights and remedies thereunder, please visit Mini-Circuit's website at www.minicircuits.com/MCLStore/terms.jsp



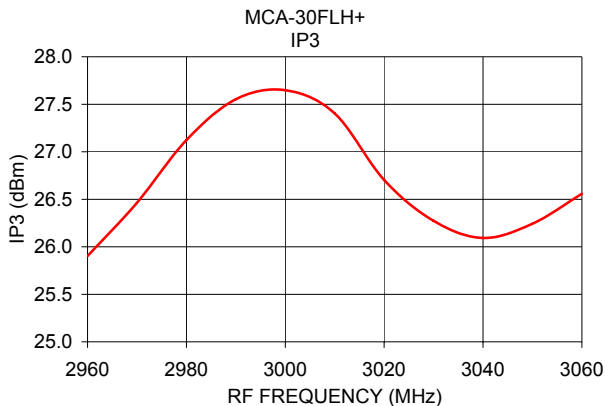
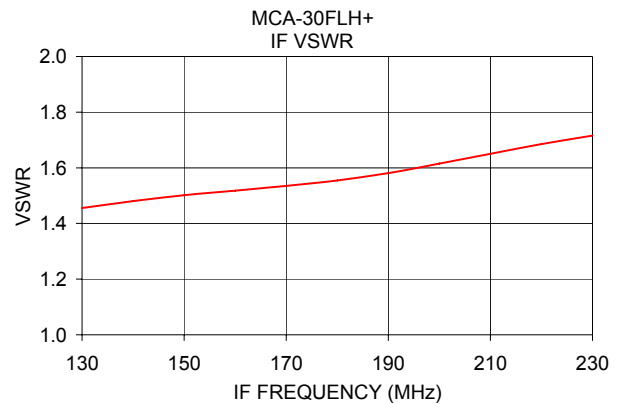
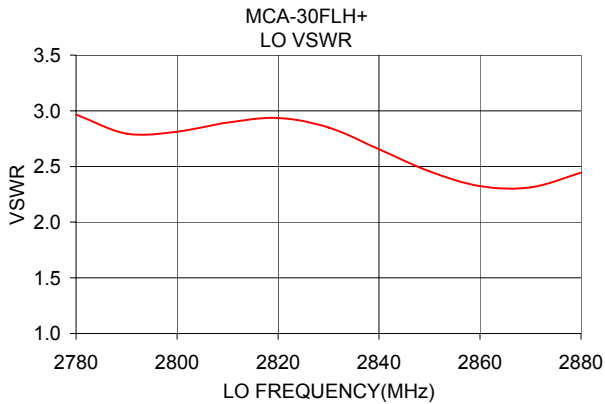
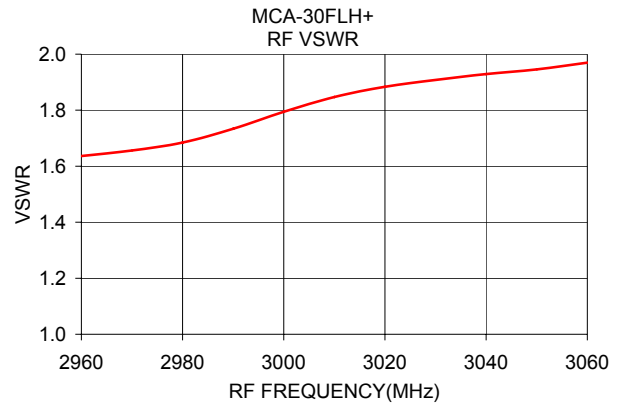
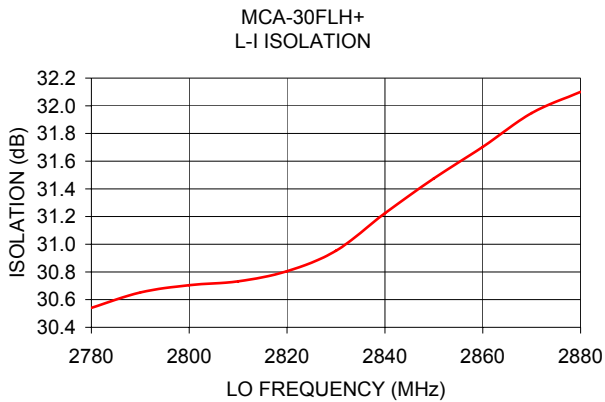
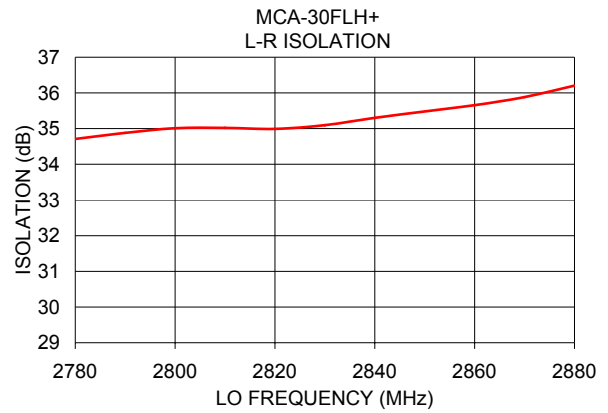
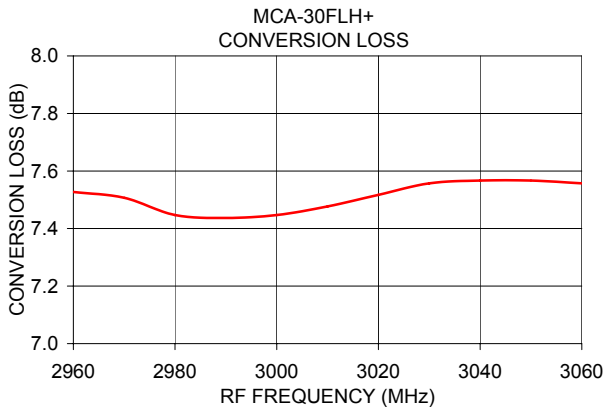

A. Performance and quality attributes and conditions not expressly stated in this specification document are intended to be excluded and do not form a part of this specification document.
 B. Electrical specifications and performance data contained in this specification document are based on Mini-Circuit's applicable established test performance criteria and measurement instructions.
 C. The parts covered by this specification document are subject to Mini-Circuits standard limited warranty and terms and conditions (collectively, "Standard Terms"); Purchasers of this part are entitled to the rights and benefits contained therein. For a full statement of the Standard Terms and the exclusive rights and remedies thereunder, please visit Mini-Circuits' website at www.minicircuits.com/MCLStore/terms.jsp