

WDD20 SERIES

DC - DC CONVERTER
15 ~ 20W SINGLE & DUAL OUTPUT



FEATURES

- EFFICIENCY UP TO 89%
- 2:1 WIDE INPUT RANGE
- I/O ISOLATION
- INPUT π FILTER
- SHORT CIRCUIT PROTECTION
- HIGH PERFORMANCE
- 3 YEARS WARRANTY

MODEL LIST

MODEL NO.	INPUT VOLTAGE	INPUT CURRENT (typ.)	OUTPUT WATTAGE	OUTPUT VOLTAGE	OUTPUT CURRENT	EFF. (min.)	EFF. (typ.)	CAPACITOR LOAD (max.)
-----------	---------------	----------------------	----------------	----------------	----------------	-------------	-------------	-----------------------

Single Output Models

WDD20 - 03S1	9~18 VDC	1.6 A	15 WATTS	+3.3 VDC	4500 mA	77%	80%	7000 μ F
WDD20 - 05S1	9~18 VDC	2.0 A	20 WATTS	+ 5 VDC	4000 mA	81%	83%	7000 μ F
WDD20 - 12S1	9~18 VDC	2.0 A	20 WATTS	+ 12 VDC	1670 mA	84%	86%	1000 μ F
WDD20 - 15S1	9~18 VDC	1.95 A	20 WATTS	+ 15 VDC	1330 mA	85%	87%	470 μ F
WDD20 - 03S2	18~36 VDC	0.78 A	15 WATTS	+3.3 VDC	4500 mA	78%	80%	7000 μ F
WDD20 - 05S2	18~36 VDC	1.0 A	20 WATTS	+ 5 VDC	4000 mA	83%	85%	7000 μ F
WDD20 - 12S2	18~36 VDC	1.0 A	20 WATTS	+ 12 VDC	1670 mA	84%	86%	1000 μ F
WDD20 - 15S2	18~36 VDC	0.96 A	20 WATTS	+ 15 VDC	1330 mA	86%	88%	470 μ F
WDD20 - 03S3	36~72 VDC	0.39 A	15 WATTS	+3.3 VDC	4500 mA	78%	80%	7000 μ F
WDD20 - 05S3	36~72 VDC	0.5 A	20 WATTS	+ 5 VDC	4000 mA	83%	85%	7000 μ F
WDD20 - 12S3	36~72 VDC	0.49 A	20 WATTS	+ 12 VDC	1670 mA	85%	87%	1000 μ F
WDD20 - 15S3	36~72 VDC	0.48 A	20 WATTS	+ 15 VDC	1330 mA	86%	88%	470 μ F

Dual Output Models

WDD20 - 12D1	9~18 VDC	2.0 A	20 WATTS	\pm 12 VDC	\pm 830 mA	83%	85%	\pm 470 μ F
WDD20 - 15D1	9~18 VDC	1.95 A	20 WATTS	\pm 15 VDC	\pm 670 mA	85%	87%	\pm 470 μ F
WDD20 - 12D2	18~36 VDC	0.97 A	20 WATTS	\pm 12 VDC	\pm 830 mA	85%	87%	\pm 470 μ F
WDD20 - 15D2	18~36 VDC	0.96 A	20 WATTS	\pm 15 VDC	\pm 670 mA	86%	88%	\pm 470 μ F
WDD20 - 12D3	36~72 VDC	0.48 A	20 WATTS	\pm 12 VDC	\pm 830 mA	85%	87%	\pm 470 μ F
WDD20 - 15D3	36~72 VDC	0.48 A	20 WATTS	\pm 15 VDC	\pm 670 mA	87%	89%	\pm 470 μ F

SPECIFICATION

All Specifications Typical At Nominal Line, Full Load, 25°C Unless Otherwise Noticed

GENERAL

Characteristics	Conditions	min.	typ.	max.	unit
Switching frequency	V_i nom, I_o nom		180		KHz
Isolation voltage	Input - Output	1,500			VDC
Isolation resistance	Input - Output, @ 500VDC	100			M Ω
Isolation capacitance	100KHz / 1V			1,000	PF

SPECIFICATION

All Specifications Typical At Nominal Line, Full Load, 25°C Unless Otherwise Noticed

GENERAL						
Characteristics	Conditions		min.	typ.	max.	unit
Ambient temperature	Vi nom,	3.3V & 5V output models	-25		+ 61	°C
	Io nom	12V, 15V & dual output models	-25		+ 71	°C
Case temperature	Operating at Vi nom, Io nom				+ 100	°C
Derating	Vi nom		See derating curve			
Storage temperature	Non operational		-40		+ 100	°C
Relative humidity	Vi nom, Io nom		20		95	% RH
Temperature coefficient	Vi nom, Io min				± 0.02	% / °C
Dimension			L50.8 x W40.64 x H10.16			mm
MTBF	Bellcore issue 6@40°C, GB			950,000		Hours
Cooling	Free air convection					

INPUT SPECIFICATIONS						
Characteristics	Conditions		min.	typ.	max.	unit
Input voltage range	Ta min ... Ta max, Io nom		9	12	18	VDC
			18	24	36	VDC
			36	48	72	VDC
No load input current	Vi nom, Io = 0	12V		20	mA	
		24V		15	mA	
		48V		10	mA	
Input voltage w/o damage	Io nom	12V		20	VDC	
		24V		40	VDC	
		48V		75	VDC	
Startup voltage	Io nom	12V	8.5		VDC	
		24V	16		VDC	
		48V	33		VDC	
Input filter	Pi type					

OUTPUT SPECIFICATIONS						
Characteristics	Conditions		min.	typ.	max.	unit
Output voltage accuracy	Vi nom, Io nom				± 2	%
Minimum load	Vi nom	single output models	0			%
		dual output models (each output)	10			%
Line regulation	Io nom, Vi min ... Vi max				± 1	%
Load regulation	Vi nom, Io 0 ... Io nom, single output models				± 2	%
	Vi nom, Io min ... Io nom, dual output models				± 5	%
Cross regulation (Dual model)	Aymmetrical load 10% - 100% FL				± 5	%
Startup time	Vi nom, Io nom				30	ms
Transient recovery time	Vi nom, I ~ 0.5 Io nom				500	µs
Ripple & noise	Vi nom, Io nom, BW = 20MHz	3.3V & 5V			100	mV
		12V, 15V & dual			150	mV
Voltage trim range 1)	Vi nom	3.3V		± 5		%
		5V, 12V, 15V & dual		± 10		%
Efficiency	Vi nom, Io nom, Po / Pi		Up to 89%, See model list and efficiency curve			

NOTE 1 : Pls refer to Fig 1 & Table 1 for connection and resistance recommended.

CONTROL AND PROTECTION	
Remote ON / OFF	ON : opened or 8 ~ 10VDC applied, reference to input GND OFF : -0.3 ~ 2VDC applied, reference to input GND
Input reversed	Shunt diode built in, external fuse recommended (12Vin : 3A, 24Vin : 1.5A, 48Vin : 1A)
Output short circuit	Current limited (Auto-recovery)
Rated over load protection	I 10%min.... I 40%max

PHYSICAL CHARACTERISTICS

Case size	50.8 x 40.64 x 10.16 mm (2 x 1.6 x 0.4 inches)
Case material	Plastic base / Metal case
Weight	60 g
Potting material	Epoxy

MECHANISM & PIN CONFIGURATION

mm [inch]

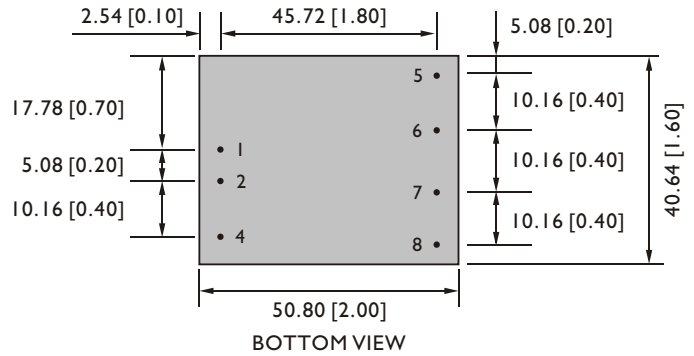
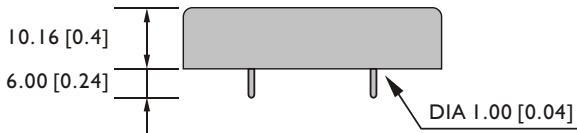

GENERAL TOLERANCE	
0.00[0.00] - 30.00[1.18]	±0.30[0.01]
30.00[1.18] - 120.00[4.72]	±0.50[0.02]

PIN ASSIGNMENT

GENERAL

PIN NO.	1	2	4	5	6	7	8
SINGLE	Vi+	Vi-	ON / OFF	NO PIN	Vo+	Vo-	Trim
DUAL	Vi+	Vi-	ON / OFF	Vo+	com	Vo-	Trim

CIRCUIT SCHEMATIC

• Block diagram for WDD20 series with single output

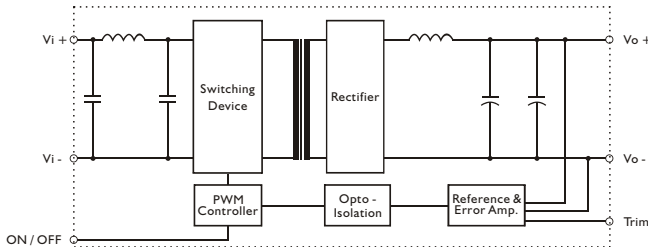

• Block diagram for WDD20 series with dual output

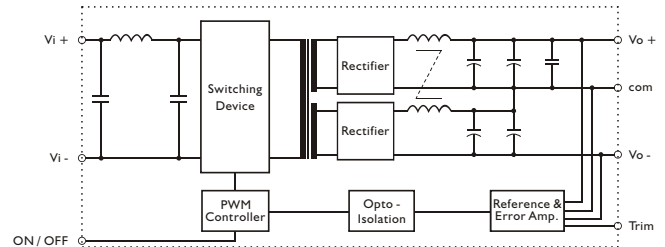

RECOMMENDED CIRCUIT

• Recommended filter for EN55022 Class B compliance

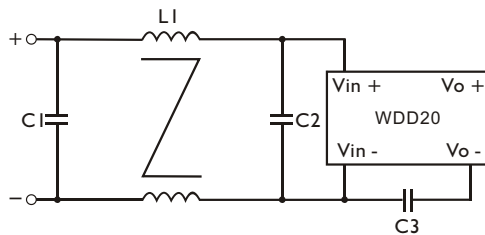

• Recommended EN 55022 Class B filter circuit layout.

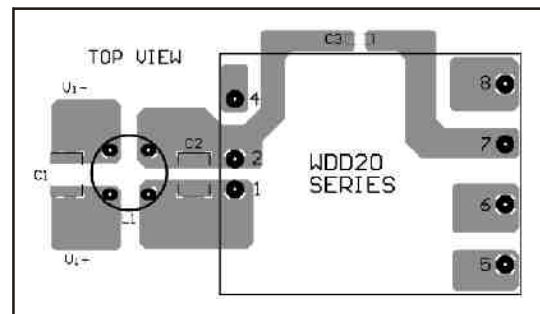

• The components used in the above figure, together with the manufacturer part numbers for these components, are as follows.

	C1	C2	C3	L1
WDD20-XXX1	3.3 μ F / 50V MLCC	3.3 μ F / 50V MLCC	InF / 2KV MLCC	1.5mH Common Choke
WDD20-XXX2	1 μ F / 50V MLCC	1 μ F / 50V MLCC	InF / 2KV MLCC	1.5mH Common Choke
WDD20-XXX3	3.3 μ F / 100V MLCC	3.3 μ F / 100V MLCC	InF / 2KV MLCC	3.5mH Common Choke

DERATING AND EFFICIENCY CURVE

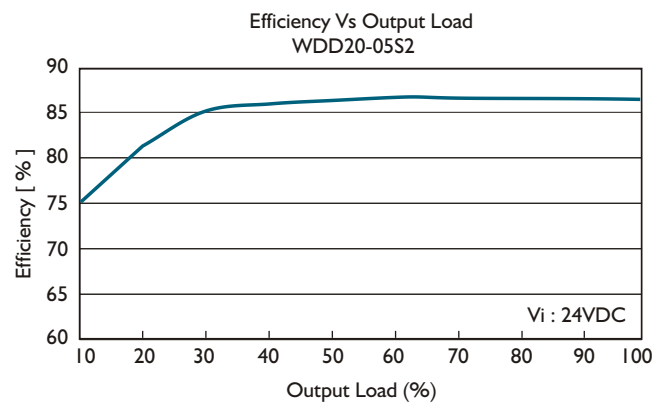
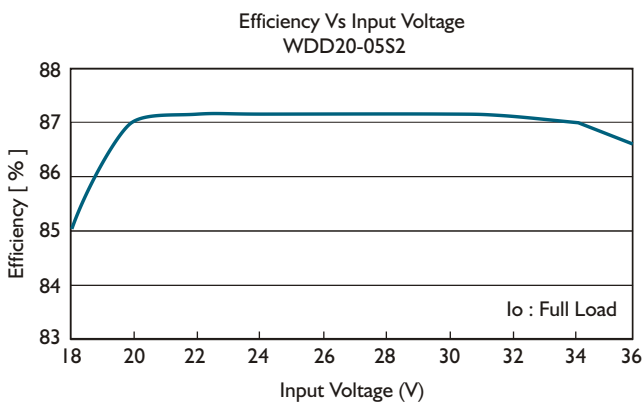
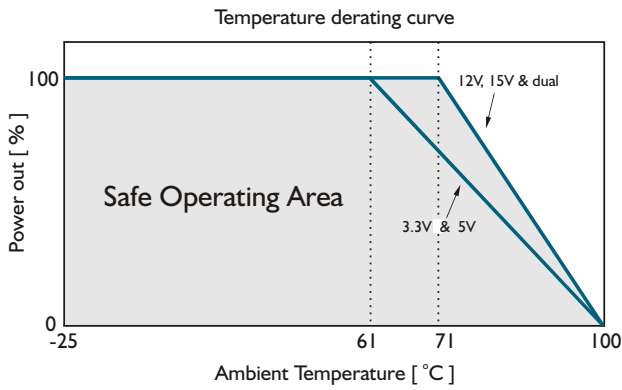
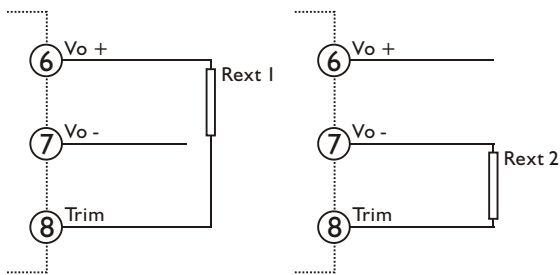

Fig. 1 Trim connection

(For Single output)



(For Dual output)

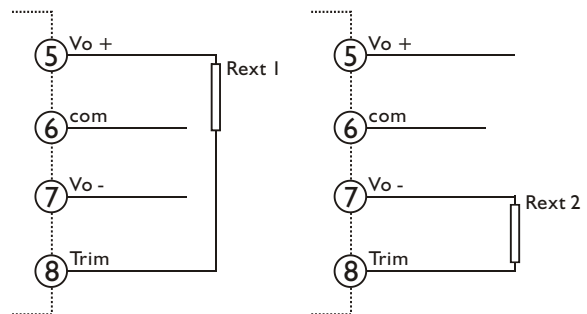

Table 1 Typical resistor values for various output voltage adjustment settings

Type	Rext 1		Rext 2	
	Vo nom -2.5%	Vo nom -5%	Vo nom +2.5%	Vo nom +5%
WDD20-03SX	1KΩ	0Ω	10KΩ	4.7KΩ
Type	Vo nom -5%	Vo nom -10%	Vo nom +5%	Vo nom +10%
WDD20-05SX	4.7KΩ	100Ω	4.7KΩ	470Ω
WDD20-12SX	30KΩ	20KΩ	10KΩ	2KΩ
WDD20-15SX	150KΩ	56KΩ	15KΩ	3KΩ
WDD20-12DX	120KΩ	56KΩ	12KΩ	2KΩ
WDD20-15DX	180KΩ	75KΩ	10KΩ	1.2KΩ