



**Model Number**

**OBD1400-R200-2EP-IO-V1**

Diffuse mode sensor  
with 4-pin, M12 x 1 connector

**Features**

- Medium design with versatile mounting options
- Extended temperature range -40°C ... 60°C
- High degree of protection IP69K
- IO-link interface for service and process data

**Product information**

The optical sensors in the series are the first devices to offer an end-to-end solution in a medium-sized standard design—from the thru-beam sensor through to the measuring distance sensor. As a result of this design, the sensors are able to perform practically all standard automation tasks.

The entire series enables sensors to communicate via IO-Link.

The DuraBeam laser sensors are durable and can be used in the same way as a standard sensor.

Multi Pixel Technology (MPT) ensures that the standard sensors are flexible and can be adapted to the application environment.

**Dimensions**

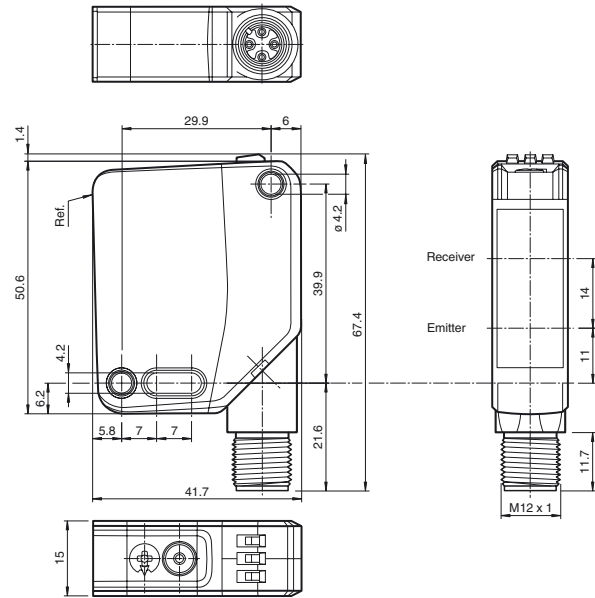

**Electrical connection**

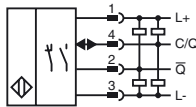

**Pinout**

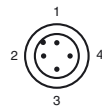

Wire colors in accordance with EN 60947-5-2

- 1 | BN (brown)
- 2 | WH (white)
- 3 | BU (blue)
- 4 | BK (black)

**Indicators/operating means**

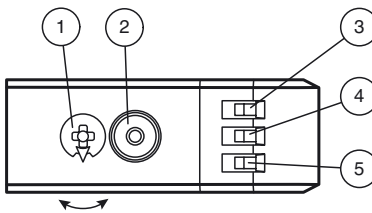

1	Sensitivity adjustment	
2	Light-on / dark-on changeover switch	
3	Operating indicator / dark on	GN
4	Signal indicator	YE
5	Operating indicator / light on	GN

Release date: 2019-02-11 10:56 Date of issue: 2019-10-31 295670-100005\_eng.xml

Refer to "General Notes Relating to Pepperl+Fuchs Product Information".

**Technical data****General specifications**

Detection range	2 ... 1400 mm
Detection range min.	100 ... 200 mm
Detection range max.	2 ... 1400 mm
Adjustment range	200 ... 1400 mm
Reference target	standard white, 100 mm x 100 mm
Light source	LED
Light type	modulated visible red light
LED risk group labelling	exempt group
Diameter of the light spot	approx. 50 mm at a distance of 1400 mm
Angle of divergence	2°
Ambient light limit	EN 60947-5-2 : 60000 Lux

**Functional safety related parameters**

MTTF <sub>d</sub>	724 a
Mission Time (T <sub>M</sub> )	20 a
Diagnostic Coverage (DC)	0 %

**Indicators/operating means**

Operation indicator	LED green: constantly on - power on flashing (4Hz) - short circuit flashing with short break (1 Hz) - IO-Link mode
Function indicator	LED yellow: constantly on - object detected constantly off - object not detected
Control elements	Light-on/dark-on changeover switch
Control elements	Sensing range adjuster

**Electrical specifications**

Operating voltage	U <sub>B</sub>	10 ... 30 V DC
Ripple		max. 10 %
No-load supply current	I <sub>0</sub>	< 18 mA at 24 V Operating voltage
Protection class		III

**Interface**

Interface type	IO-Link ( via C/Q = pin 4 )
Device profile	Identification and diagnosis Smart Sensor type 2.4
Transfer rate	COM 2 (38.4 kBaud)
IO-Link Revision	1.1
Min. cycle time	2.3 ms
Process data width	Process data input 1 Bit Process data output 2 Bit
SIO mode support	yes
Device ID	0x111101 (1118465)
Compatible master port type	A

**Output**

Switching type	The switching type of the sensor is adjustable. The default setting is: C/Q - Pin4: NPN normally open / light-on, PNP normally closed / dark-on, IO-Link /Q - Pin2: NPN normally closed / dark-on, PNP normally open / light-on	
Signal output	2 push-pull (4 in 1) outputs, short-circuit protected, reverse polarity protected, overvoltage protected	
Switching voltage	max. 30 V DC	
Switching current	max. 100 mA , resistive load	
Usage category	DC-12 and DC-13	
Voltage drop	U <sub>d</sub>	≤ 1.5 V DC
Switching frequency	f	1000 Hz
Response time		0.5 ms

**Conformity**

Communication interface	IEC 61131-9
Product standard	EN 60947-5-2

**Ambient conditions**

Ambient temperature	-40 ... 60 °C (-40 ... 140 °F)
Storage temperature	-40 ... 70 °C (-40 ... 158 °F)

**Mechanical specifications**

Housing width	15 mm
Housing height	50.6 mm
Housing depth	41.7 mm
Degree of protection	IP67 / IP69 / IP69K
Connection	4-pin, M12 x 1 connector, 90° rotatable
Material	
Housing	PC (Polycarbonate)
Optical face	PMMA
Mass	approx. 37 g

**Approvals and certificates****Accessories****IO-Link-Master02-USB**

IO-Link master, supply via USB port or separate power supply, LED indicators, M12 plug for sensor connection

**V1-G-2M-PUR**

Female cordset, M12, 4-pin, PUR cable

**V1-W-2M-PUR**

Female cordset, M12, 4-pin, PUR cable

**OMH-MLV12-HWG**

Mounting bracket for series MLV12 sensors

**OMH-MLV12-HWK**

Mounting bracket for series MLV12 sensors

**OMH-R200-01**

Mounting aid for round steel ø 12 mm or sheet 1.5 mm ... 3 mm

**OMH-R20x-Quick-Mount**

Quick mounting accessory

Other suitable accessories can be found at [www.pepperl-fuchs.com](http://www.pepperl-fuchs.com)

UL approval

E87056 , cULus Listed , class 2 power supply , type rating 1

CCC approval

CCC approval / marking not required for products rated ≤36 V

**Curves/Diagrams**

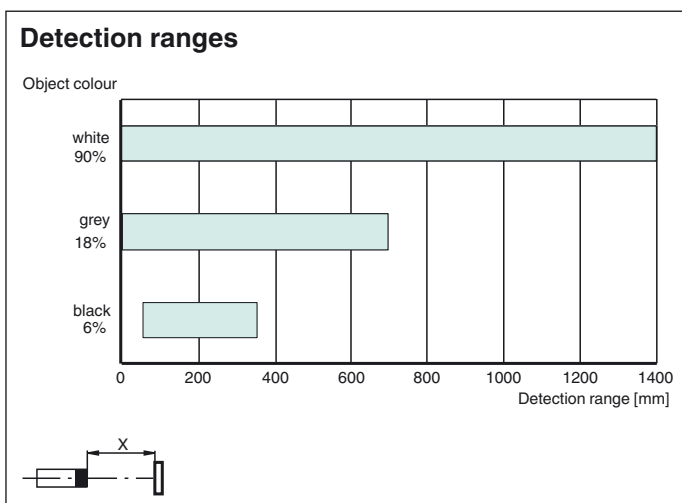
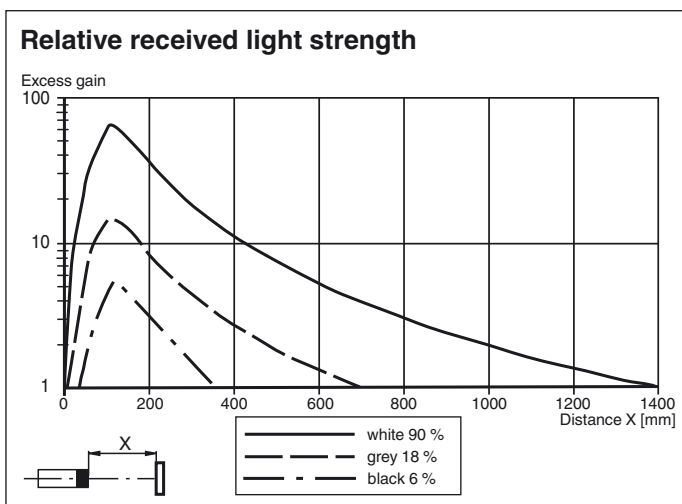
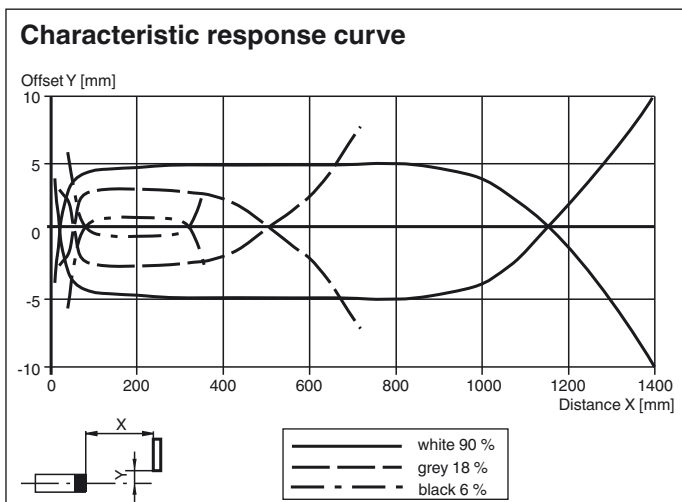

**Functions and Operation**

To unlock the adjustment functions turn the sensing range /sensitivity adjuster for more than 180 degrees.

**Sensing Range / Sensitivity**

Turn sensing range / sensitivity adjuster clockwise to increase sensing range / sensitivity.

Turn sensing range / sensitivity adjuster counter clockwise to decrease sensing range / sensitivity.

If the end of the adjustment range is reached, the signal indicator starts flashing with 8 Hz.

Release date: 2019-02-11 10:56 Date of issue: 2019-10-31 295670-100005\_eng.xml

Refer to "General Notes Relating to Pepperl+Fuchs Product Information".

### Light-on / Dark-on Configuration

Press the light-on / dark-on changeover switch for more than 1 second (less than 4 seconds). The light-on / dark-on mode changes and the operating indicators are activated accordingly.

If you press the light-on / dark-on changeover switch for more than 4 seconds, the light-on /dark-on mode changes back to the original setting. On release of the light-on / dark-on changeover switch the current state is activated.

### Restore Factory Settings

Press the light-on / dark-on changeover switch for more than 10 seconds (less than 30 seconds) until all LEDs turn off. On release of the light-on / dark-on changeover switch the signal indicator turns on. After 5 seconds the sensor resumes operation with factory default settings.

After 5 minutes of inactivity the sensing range / sensitivity adjustment is locked. In order to reactivate the sensing range / sensitivity adjustment, turn the sensing range /sensitivity adjuster for more than 180 degrees.