

MAPD-009492-C2W180



Power divider, 2 Way 180 degree Splitter (also a 1:2 flux coupled balun)
5 to 1200 MHz

M/A-COM Products
Rev. V2

Features

- Surface mount
- 180° phase between outputs
- RoHS* compliant
- Available on tape and reel.

Description

M/A Com's MAPD-009492-C2W180 is a 2 way 180° power divider in a low cost, surface mount package. Ideally suited for high volume broadband CATV applications.

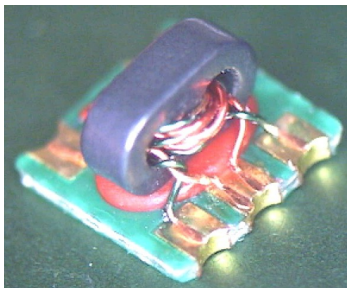

Schematic

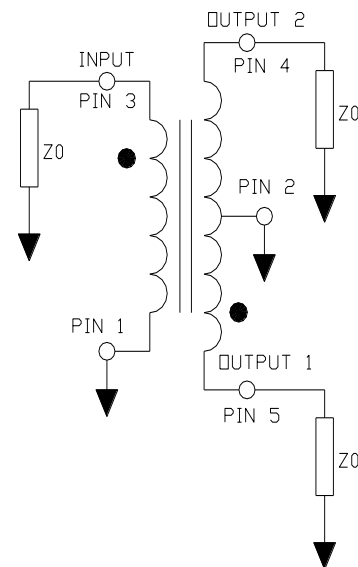

Case style: SM-164

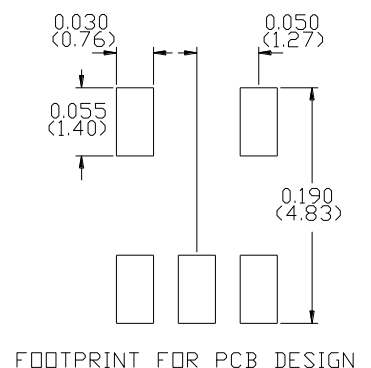
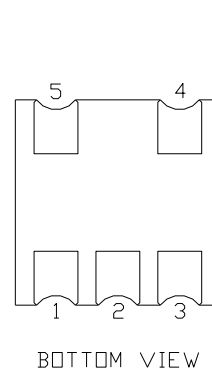
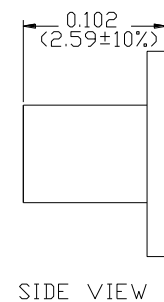
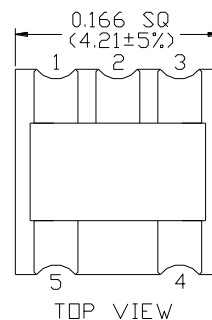

Pin configuration

Pin no.	Function
1	Ground
2	Ground
3	Input
4	Output 2
5	Output 1

Ordering information

Part number	Description
MAPD-009492-C2W180	Reel Quantity 2000
MAPD-009492-C2W1TB	Customer Test Board

Note: Reference Application Note **M513** for reel size information.

Dimensions in inches [mm] Tolerance: .xx ± .02, .xxx ± .010, unless otherwise stated

* Restrictions on Hazardous Substances, European Union Directive 2002/95/

1

ADVANCED: Data Sheets contain information regarding a product M/A-COM Technology Solutions is considering for development. Performance is based on target specifications, simulated results, and/or prototype measurements. Commitment to develop is not guaranteed.
PRELIMINARY: Data Sheets contain information regarding a product M/A-COM Technology Solutions has under development. Performance is based on engineering tests. Specifications are typical. Mechanical outline has been fixed. Engineering samples and/or test data may be available. Commitment to produce in volume is not guaranteed.

• **North America** Tel: 800.366.2266 • **Europe** Tel: +353.21.244.6400
• **India** Tel: +91.80.4155721 • **China** Tel: +86.21.2407.1588
Visit www.macomtech.com for additional data sheets and product information.

M/A-COM Technology Solutions Inc. and its affiliates reserve the right to make changes to the product(s) or information contained herein without notice.

MAPD-009492-C2W180



Power divider, 2 Way 180 degree Splitter (also a 1:2 flux coupled balun)
5 to 1200 MHz

M/A-COM Products
Rev. V2

Electrical Specifications: $T_A = 25^\circ\text{C}$, 0dBm, $Z_0 = 75\Omega$

Parameter	Test Conditions	Units	Min	Typ	Max
Insertion Loss 1 Pin 5-3	5 - 200 MHz	dB	-	0.7	1.0
	200 - 870 MHz	dB	-	1.3	2.5
	870 - 1200 MHz	dB	-	2.7	4.5
Insertion Loss 2 Pin 4-3	5 - 50 MHz	dB	-	0.6	1.2
	50 - 870 MHz	dB	-	0.6	0.9
	870 - 1000 MHz	dB	-	0.0	0.5
	1000 - 1200 MHz	dB	-	-0.3	0.2
Amplitude Balance (Nominal 0dB)	5 - 500 MHz	dB	-	0.2	± 1.0
	500 - 870 MHz	dB	-	1.3	± 2.5
	870 - 1000 MHz	dB	-	2.4	± 3.5
	1000 - 1200MHz	dB	-	3.4	± 5.0
Phase Balance (Nominal 180°)	5 - 200 MHz	°	-	0.1	± 3.0
	200 - 870 MHz	°	-	1.3	± 9.0
	870 - 1000 MHz	°	-	4.0	± 13.0
	1000 - 1200 MHz	°	-	11.0	± 20.0
Input Return Loss	5 - 870 MHz	dB	18	24	-
	870 - 1000 MHz	dB	17	22	-
	1000 - 1200 MHz	dB	12	18	-

Absolute maximum ratings

Parameter	Absolute maximum
RF power	50mW
Peak IF current	40mA
Operating Temperature	-40°C to +85°C
Storage Temperature	-40°C to +85°C

MAPD-009492-C2W180



Power divider, 2 Way 180 degree Splitter (also a 1:2 flux coupled balun)
5 to 1200 MHz

M/A-COM Products
Rev. V2

Typical Performance Curves: $T_A = 25^\circ\text{C}$, $Z_0 = 75\Omega$

Insertion Loss 1: Pin 5-3

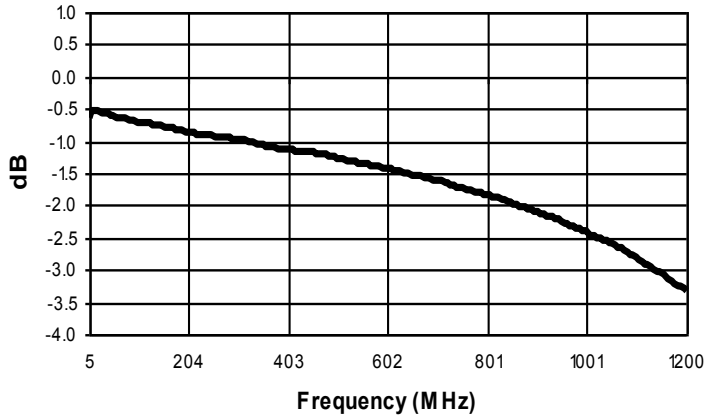

Insertion Loss 2: Pin 4-3

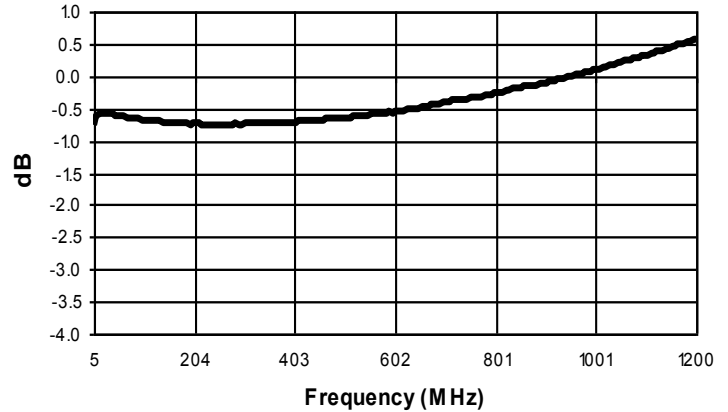

Amplitude Balance

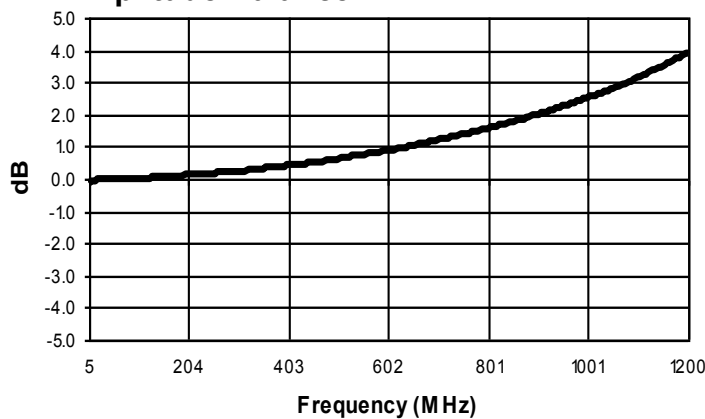

Phase Balance

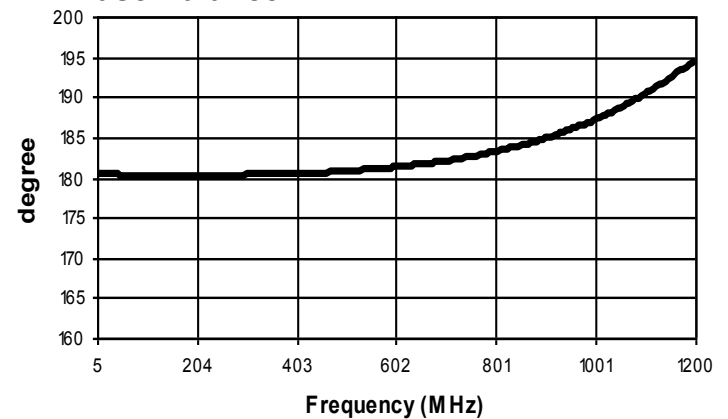

Input Return Loss: Pin 3

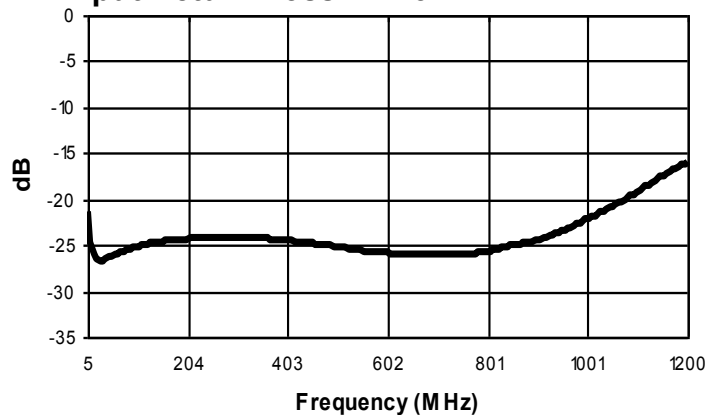

ADVANCED: Data Sheets contain information regarding a product M/A-COM Technology Solutions is considering for development. Performance is based on target specifications, simulated results, and/or prototype measurements. Commitment to develop is not guaranteed.
PRELIMINARY: Data Sheets contain information regarding a product M/A-COM Technology Solutions has under development. Performance is based on engineering tests. Specifications are typical. Mechanical outline has been fixed. Engineering samples and/or test data may be available. Commitment to produce in volume is not guaranteed.

• North America Tel: 800.366.2266 • Europe Tel: +353.21.244.6400
• India Tel: +91.80.4155721 • China Tel: +86.21.2407.1588
Visit www.macomtech.com for additional data sheets and product information.

M/A-COM Technology Solutions Inc. and its affiliates reserve the right to make changes to the product(s) or information contained herein without notice.