

35

357000

RAST 2.5 connectors, pitch 2.5/5.0 mm



RAST 2.5 Power plus™ connector for direct and indirect mating, insulation displacement technology (IDT), with double-sided keying
contact pitch 5.0 mm

35 357000

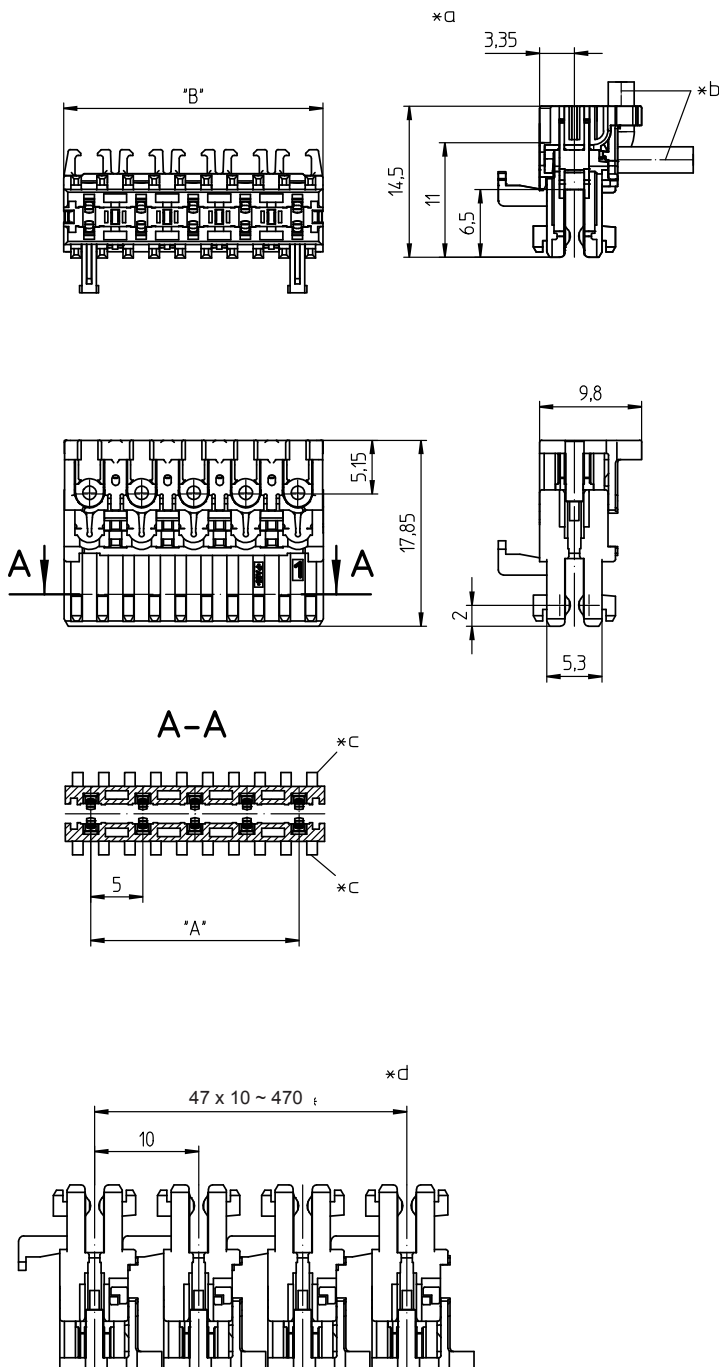

Environmental conditions

Temperature range -40 °C/+130 °C¹

¹ upper limit temperature (insulating body) RTI (electrical) of the UL Yellow Card

Materials

Insulating body PA, V-0 according to UL94¹
Contact spring Cu alloy, tin-plated – 357000
Cu alloy, silver-plated – 357000 V168

¹ material halogen-free, GWFI 850 °C (0.40 mm) according to IEC 60695-2-12, GWIT 775 °C (0.40 mm) according to IEC 60695-2-213

Mechanical data

Mating with printed circuit board 1.5 ± 0.14 mm
Keying proposals at www.lumberg.com 









Connectable conductors for IDT area

Construction discrete conductor, notched flat cable 5.0 mm
Section min. 0,5 mm²
Section max. 0,75 mm²
Insulation diameter ≤ 2,5 mm
Approved cables at www.lumberg.com 

Electrical data (at T_{amb} 20 °C)

Contact resistance ≤ 10 mΩ
Rated current 357000: 6 A (T_{sub>U}> 70 °C)
357000 V168: 6 A (T_{sub>U}> 70 °C)
10 A (indirekt gesteckt, 2- bis 4-polig)
Rated voltage 400 V AC
Material group I (IEC)/0 (UL) (CTI ≥ 600)
Creepage distance 3,2 mm
Clearance 3,2 mm
Insulation resistance > 1 GΩ</sub></sub>

Associated products

Counterparts
 3542  3542-1  3546
 3546-1  3552  355295
 355299  3556  83546

35

357000

-
- *a terminated connector
 - *b cable departure
 - *c keying
 - *d chaining of the component parts (state of delivery)

Harnessing equipment

- | | | |
|----------------------------|------------------------------|---------------------------------|
| HA3...e | HA357 plus | HZ35-K |
| KHP35 plus | VARICON 7000 | VARICON 7000-RD |
-

35

357000

Designation	Pole Number	PU (Pieces)	MDQ (Pieces)	Dimensions	
				A (mm)	B (mm)
357000 02	2	3456	3456	5	9.9
357000 03	3	2160	2160	10	14.9
357000 04	4	1728	1728	15	19.9
357000 05	5	1296	1296	20	24.9
357000 06	6	864	864	25	29.9
357000 07	7	864	864	30	34.9
357000 08	8	864	864	35	39.9

Designation to be completed by further details (e.g. for keying, color or material options).

Packaging:

chained, in a cardboard box