

IGBT Module

Short Circuit SOA Capability
Square RBSOA

Preliminary Data Sheet

PSIG 25/06
PSI 25/06*
PSIS 25/06*
PSSI 25/06*

$I_{C25} = 24.5 \text{ A}$
 $V_{CES} = 600 \text{ V}$
 $V_{CE(sat)typ.} = 2.4 \text{ V}$

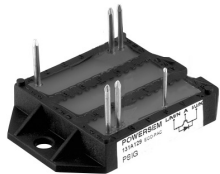

PSIG 25/06

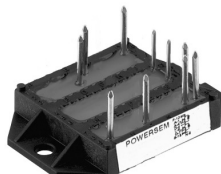

PSI 25/06*

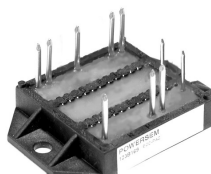

PSSI 25/06*

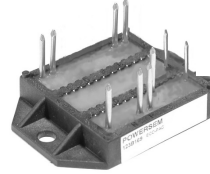

PSIS 25/06*

*NTC optional

IGBTs

Symbol	Conditions	Maximum Ratings	
V_{CES}	$T_{VJ} = 25^\circ\text{C to } 150^\circ\text{C}$	600	V
V_{GES}		± 20	V
I_{C25}	$T_C = 25^\circ\text{C}$	24.5	A
I_{C80}	$T_C = 80^\circ\text{C}$	17	A
I_{CM} V_{CEK}	$V_{GE} = \pm 15 \text{ V}; R_G = 68 \Omega; T_{VJ} = 125^\circ\text{C}$ RBSOA, Clamped inductive load; $L = 100 \mu\text{H}$	30	A
t_{SC} (SCSOA)	$V_{CE} = V_{CES}; V_{GE} = \pm 15 \text{ V}; R_G = 68 \Omega; T_{VJ} = 125^\circ\text{C}$ non-repetitive	10	μs
P_{tot}	$T_C = 25^\circ\text{C}$	82	W

Symbol	Conditions	Characteristic Values		
		(T _{VJ} = 25°C, unless otherwise specified)		
		min.	typ.	max.
$V_{CE(sat)}$	$I_C = 25 \text{ A}; V_{GE} = 15 \text{ V}; T_{VJ} = 25^\circ\text{C}$ $T_{VJ} = 125^\circ\text{C}$		2.4	2.9
$V_{GE(th)}$	$I_C = 0.4 \text{ mA}; V_{GE} = V_{CE}$	4.5		6.5
I_{CES}	$V_{CE} = V_{CES}; V_{GE} = 0 \text{ V}; T_{VJ} = 25^\circ\text{C}$ $T_{VJ} = 125^\circ\text{C}$			0.6 2.7
I_{GES}	$V_{CE} = 0 \text{ V}; V_{GE} = \pm 20 \text{ V}$			100
$t_{d(on)}$ t_r $t_{d(off)}$ t_f E_{on} E_{off}	Inductive load, $T_{VJ} = 125^\circ\text{C}$ $V_{CE} = 300 \text{ V}; I_C = 15 \text{ A}$ $V_{GE} = 15/0 \text{ V}; R_G = 68 \Omega$		30	ns
			45	ns
			270	ns
			40	ns
			0.7	mJ
			0.5	mJ
C_{ies}	$V_{CE} = 25 \text{ V}; V_{GE} = 0 \text{ V}; f = 1 \text{ MHz}$		8	nF
R_{thJC} R_{thJH}	(per IGBT) with heatsink compound (0.42 K/m.K; 50 μm)		3	1.52 K/W

Caution: These Devices are sensitive to electrostatic discharge. Users should observe proper ESD handling precautions.

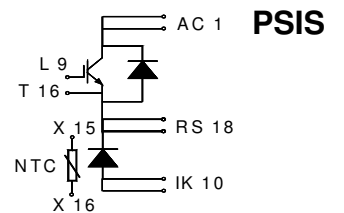
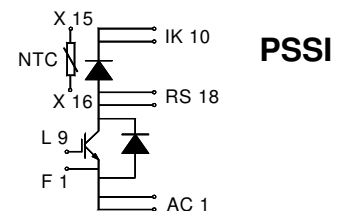
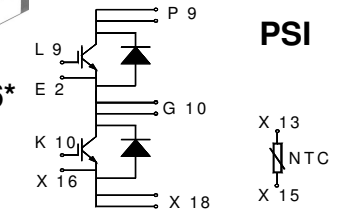
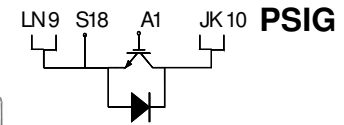

Features

- Package with DCB ceramic base plate
- Isolation voltage 3000 V~
- Planar glass passivated chips
- Low forward voltage drop
- Leads suitable for PC board soldering
- UL registered, E 148688

Applications

- AC and DC motor control
- AC servo and robot drives
- power supplies
- welding inverters

Advantages

- Easy to mount with two screws
- Space and weight savings
- Improved temperature and power cycling capability
- High power density
- Small and light weight
- Leads with expansion bend for stress relief

Reverse diodes (FRED)

Symbol	Conditions	Maximum Ratings	
I_{F25}	$T_C = 25^\circ\text{C}$	18.5	A
I_{F80}	$T_C = 80^\circ\text{C}$	12.0	A

Symbol	Conditions	Characteristic Values		
		min.	typ.	max.
V_F	$I_F = 15\text{ A}; T_{VJ} = 25^\circ\text{C}$ $T_{VJ} = 125^\circ\text{C}$	2.58	2.64	V
I_{RM} t_{rr}	$I_F = 10\text{ A}; di_F/dt = 400\text{ A}/\mu\text{s}; T_{VJ} = 125^\circ\text{C}$ $V_R = 300\text{ V}; V_{GE} = 0\text{ V}$	7		A
R_{thJC} R_{thJH}	with heatsink compound (0.42 K/m.K; 50 μm)	7		3.5 K/W K/W

Temperature Sensor NTC

Symbol	Conditions	Characteristic Values		
		min.	typ.	max.
R_{25}	$T = 25^\circ\text{C}$	4.75	5.0	k Ω
$B_{25/50}$			3375	K

Module

Symbol	Conditions	Maximum Ratings	
T_{VJ}		-40...+150	$^\circ\text{C}$
T_{stg}		-40...+150	$^\circ\text{C}$
V_{ISOL}	$I_{ISOL} \leq 1\text{ mA}; 50/60\text{ Hz}$	3000	V~
M_d	Mounting torque (M4)	1.5 - 2.0	Nm
		14 - 18	lb.in.
a	Max. allowable acceleration	50	m/s^2

Symbol	Conditions	Characteristic Values		
		min.	typ.	max.
d_S	Creepage distance on surface (Pin to heatsink)	11.2		mm
d_A	Strike distance in air (Pin to heatsink)	11.2		mm

Weight		24	g
---------------	--	----	---

Package style and outline

Dimensions in mm (1mm = 0.0394")

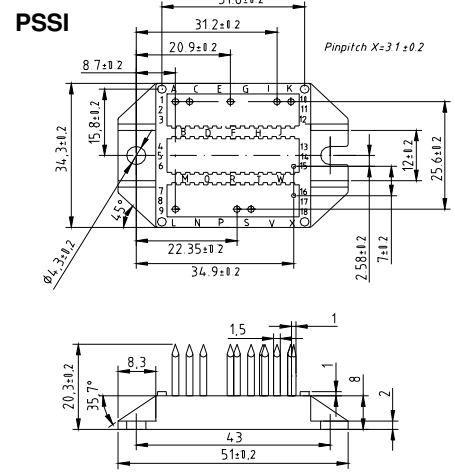
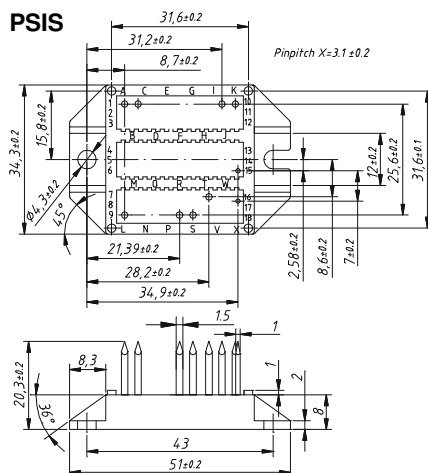
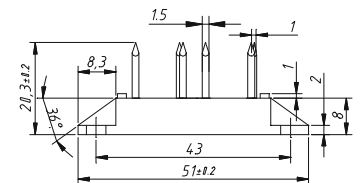
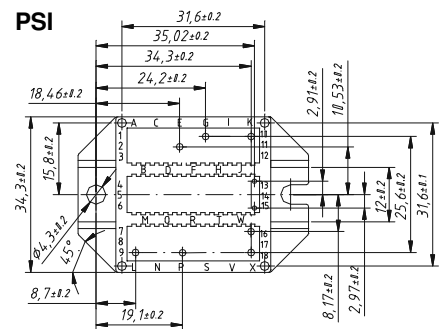
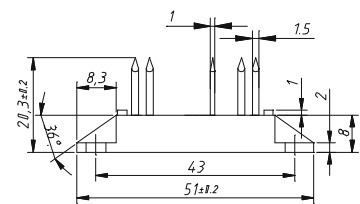
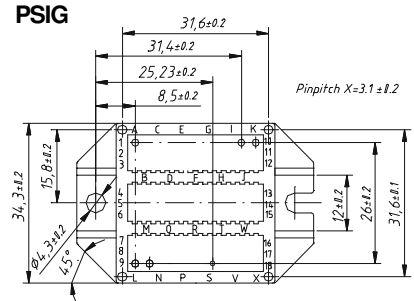

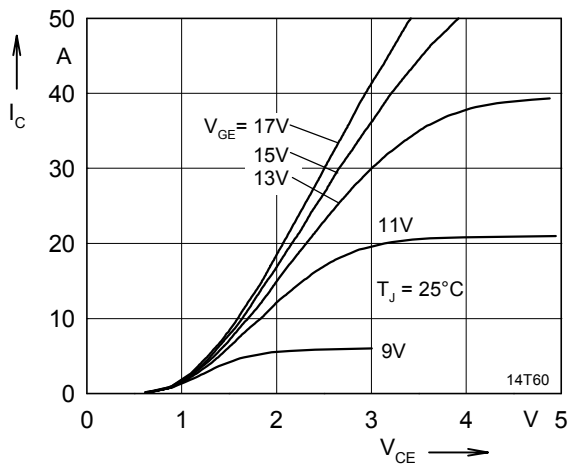

Fig. 1 Typ. output characteristics

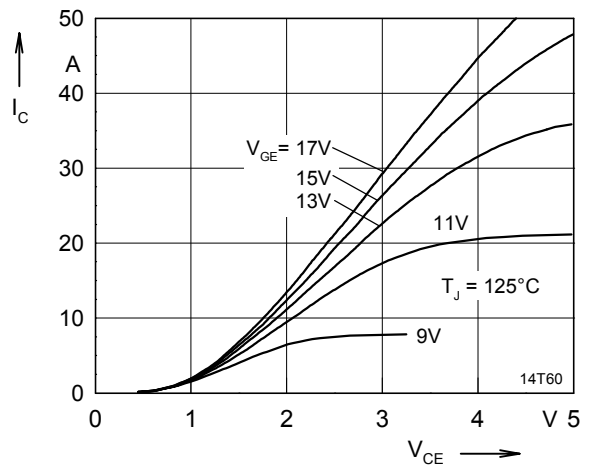

Fig. 2 Typ. output characteristics

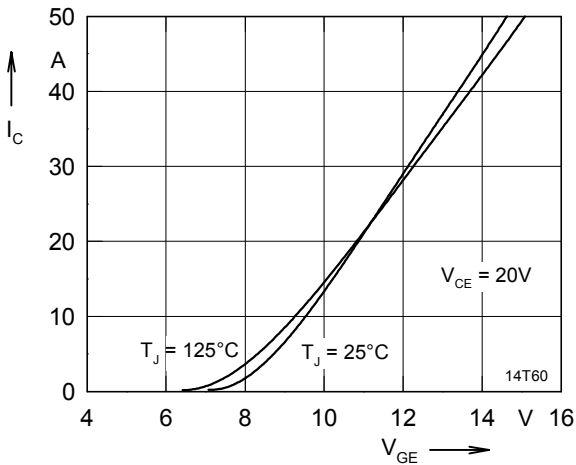

Fig. 3 Typ. transfer characteristics

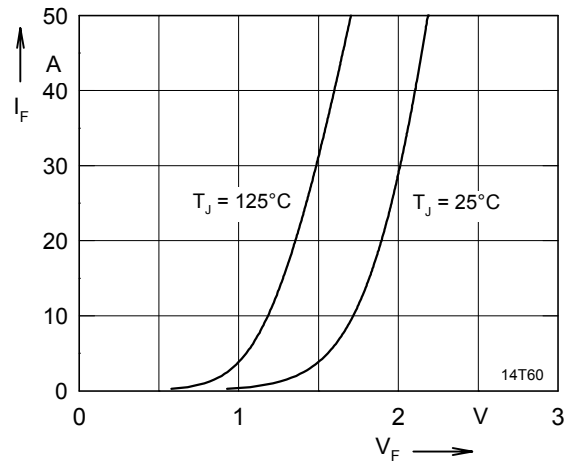

Fig. 4 Typ. forward characteristics of free wheeling diode

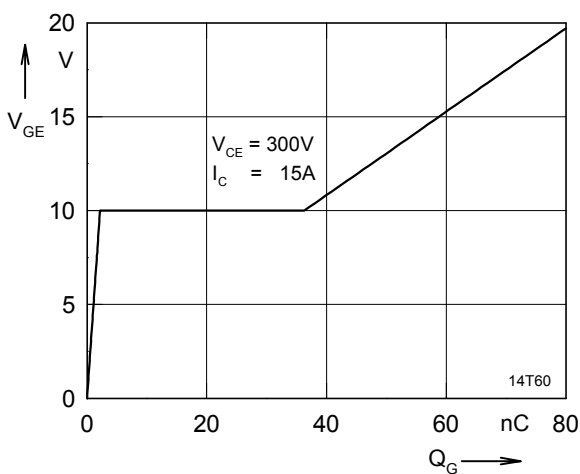

Fig. 5 Typ. turn on gate charge

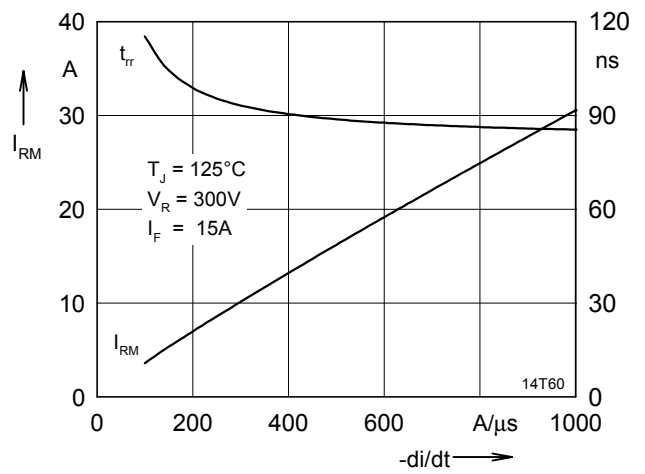

Fig. 6 Typ. turn off characteristics of free wheeling diode

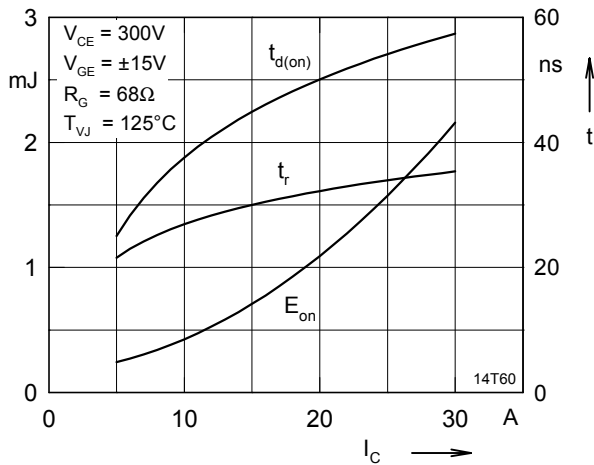

Fig. 7 Typ. turn on energy and switching

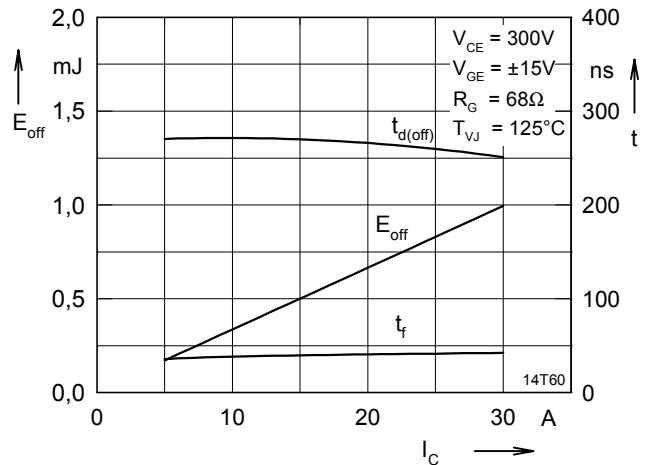

Fig. 8 Typ. turn off energy and switching times versus collector current times versus collector current

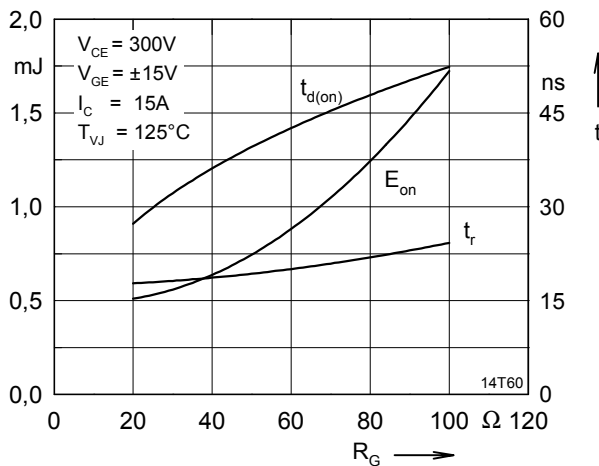

Fig. 9 Typ. turn on energy and switching

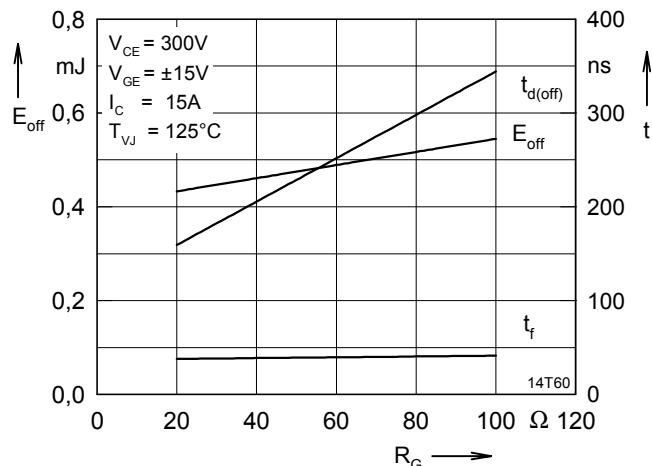

Fig. 10 Typ. turn off energy and switching times versus gate resistor times versus gate resistor

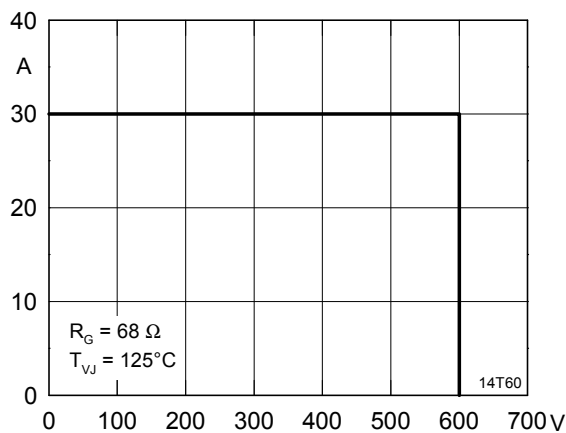

Fig. 11 Reverse biased safe operating area

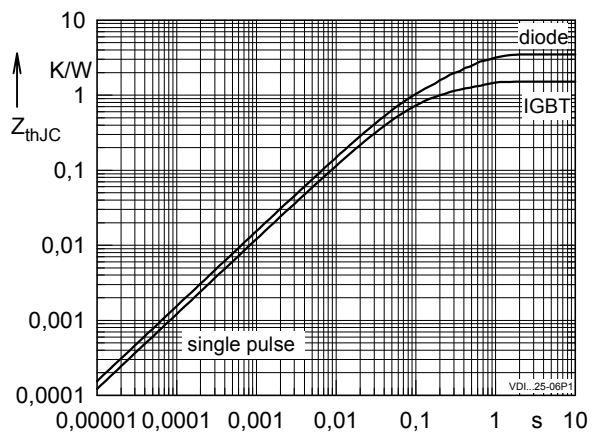

Fig. 12 Typ. transient thermal impedance RBSOA