

FEATURES

- Maximum output current
 $I_{OM}: 0.1A$
- Output voltage
 $V_o: -5V$
- Continuous total dissipation
 $P_D: 0.6W (T_a = 25^\circ C)$

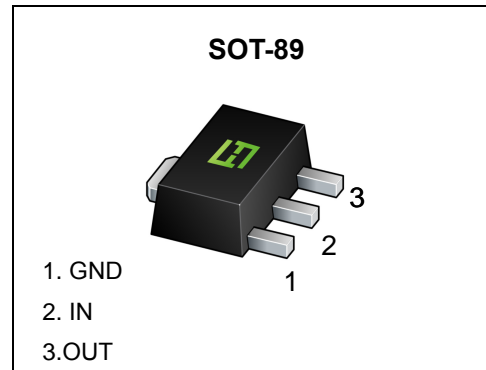

ABSOLUTE MAXIMUM RATINGS (Operating temperature range applies unless otherwise specified)

Parameter	Symbol	Value	Unit
Input Voltage	V_i	-30	V
Thermal Resistance from Junction to Ambient	$R_{\theta JA}$	208.3	$^\circ C/W$
Operating Junction Temperature Range	T_{OPR}	-40~+125	$^\circ C$
Storage Temperature Range	T_{STG}	-65~+150	$^\circ C$

ELECTRICAL CHARACTERISTICS AT SPECIFIED VIRTUAL JUNCTION TEMPERATURE

($V_i = -10V, I_o = 40mA, C_i = 0.33\mu F, C_o = 0.1\mu F$, unless otherwise specified)

Parameter	Symbol	Test conditions	Mj	Tnd	Max	Unit
Output Voltage	V_o	$25^\circ C$	-4.8	-5.0	-5.2	V
		$-7V \leq V_i \leq -20V, I_o = 1mA \sim 40mA$	-4.75	-5.0	-5.25	V
		$0-125^\circ C$ $I_o = 1mA \sim 70mA$	-4.75	-5.0	-5.25	V
Load Regulation	ΔV_o	$I_o = 1mA \sim 100mA$ $25^\circ C$		20	60	mV
		$I_o = 1mA \sim 40mA$ $25^\circ C$		10	30	mV
Line Regulation	ΔV_o	$-7V \leq V_i \leq -20V$ $25^\circ C$		15	150	mV
		$-8V \leq V_i \leq -20V$ $25^\circ C$		12	100	mV
Quiescent Current	I_q	$25^\circ C$			6	mA
Quiescent Current Change	ΔI_q	$-8V \leq V_i \leq -20V$ $0-125^\circ C$			1.5	mA
	ΔI_q	$1mA \leq V_i \leq 40mA$ $0-125^\circ C$			0.1	mA
Output Noise Voltage	V_N	$10Hz \leq f \leq 100KHz$ $25^\circ C$		40		$\mu V/V_o$
Ripple Rejection	RR	$-8V \leq V_i \leq -18V, f = 120Hz$ $0-125^\circ C$	41	49		dB
Dropout Voltage	V_d	$25^\circ C$		1.7		V

* Pulse test.

TYPICAL APPLICATION

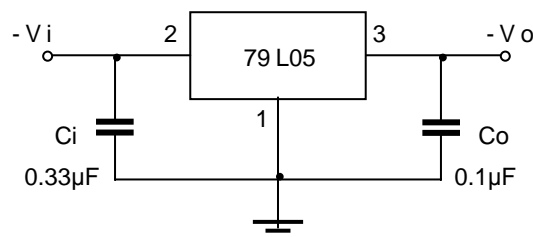

Note : Bypass capacitors are recommended for optimum stability and transient response and should be located as close as Possible to the regulators.

Typical Characteristics

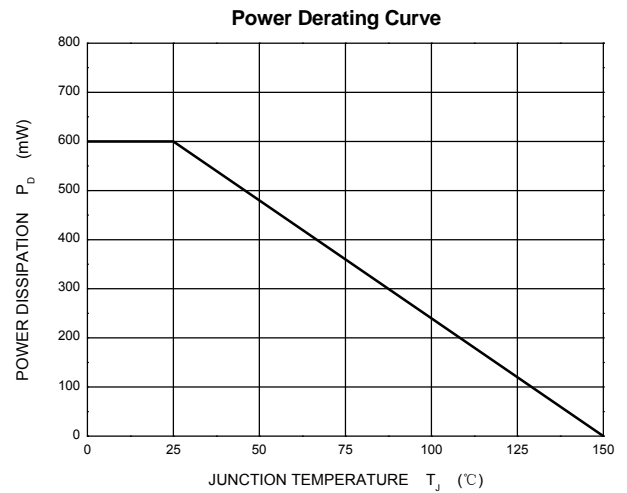
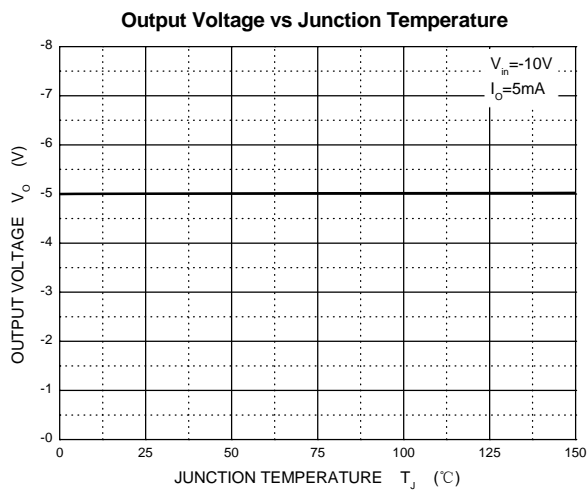
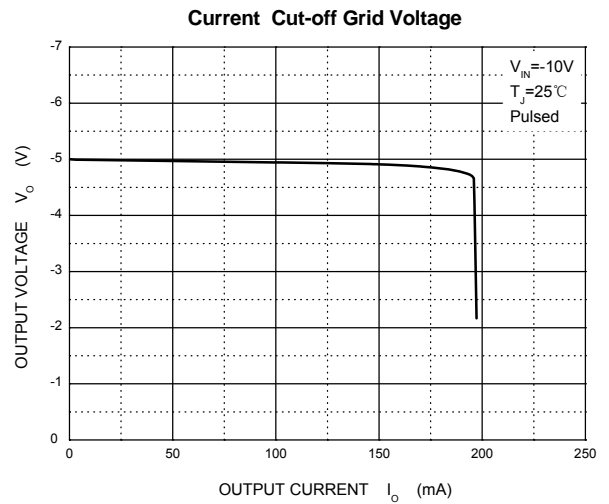
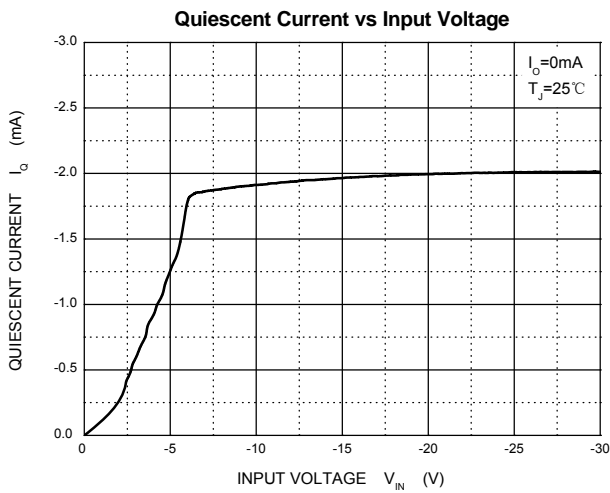
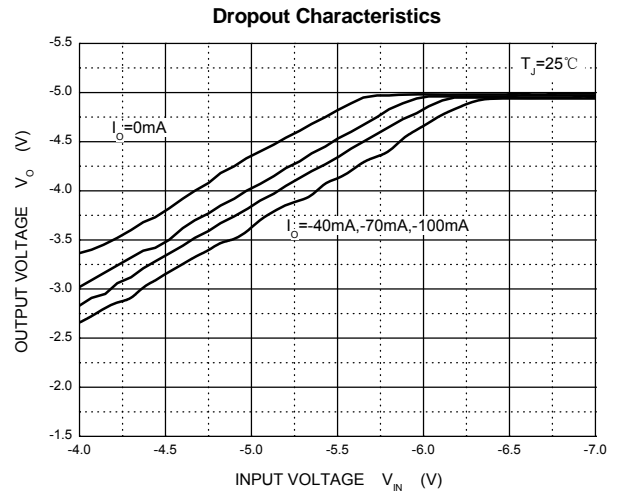
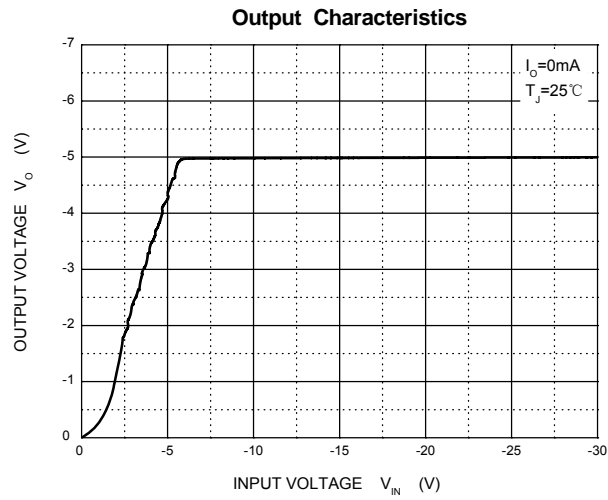

SOT-89 Package Outline Dimensions

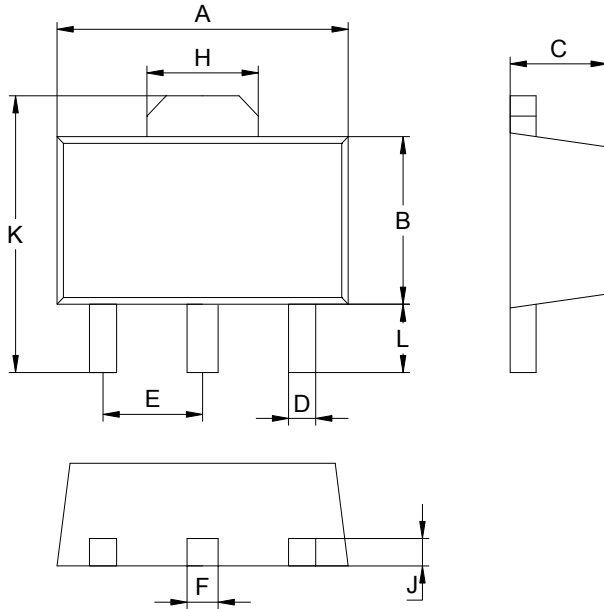

SOT-89		
Dim	Min	Max
A	4.30	4.70
B	2.20	2.70
C	1.30	1.70
D	0.30	0.60
E	1.40	1.60
F	0.30	0.60
H	1.40	1.80
J	0.30	0.60
L	0.90	1.10
K	3.75	4.35
All Dimensions in mm		

SOT-89 Suggested Pad Layout

