

PLEASE CHECK WWW.MOLEX.COM FOR LATEST PART INFORMATION

Part Number: [0712430002](#)
Status: **Active**
Description: 1.27mm (.050") Pitch DIMM Socket, Single Key, Vertical, Plastic Peg, 144 Circuits

Documents:

[3D Model](#) [Product Specification PS-71243-9999 \(PDF\)](#)
[Drawing \(PDF\)](#) [RoHS Certificate of Compliance \(PDF\)](#)

Agency Certification

CSA LR19980
 UL E29179

General

Product Family Memory Module Sockets
 Series [71243](#)
 Component Type Memory Module
 JEDEC Outline MO-167
 Product Name DIMM

Physical

Circuits (Loaded) 144
 Color - Resin Black, Natural
 Durability (mating cycles max) 25
 Entry Angle Vertical (Top Entry)
 Flammability 94V-0
 Keying to Mating Part None
 Material - Metal Phosphor Bronze, Stainless Steel
 Material - Plating Mating Gold
 Material - Plating Termination Tin
 Material - Resin High Temperature Thermoplastic
 PCB Retention Yes
 Packaging Type Tray
 Pitch - Mating Interface (in) 0.050 In
 Pitch - Mating Interface (mm) 1.27 mm
 Plating min: Mating (µin) 2
 Plating min: Mating (µm) 0.05
 Plating min: Termination (µin) 150
 Plating min: Termination (µm) 3.81
 Temperature Range - Operating -40°C to +85°C
 Termination Interface: Style Through Hole

Electrical

Current - Maximum per Contact 1A
 Voltage - Maximum 100V
 Voltage Key NO

Solder Process Data

Lead-free Process Capability Wave Capable (TH only)

Material Info

Reference - Drawing Numbers

Product Specification PS-71243-9999
 Sales Drawing SDA-71243-0****

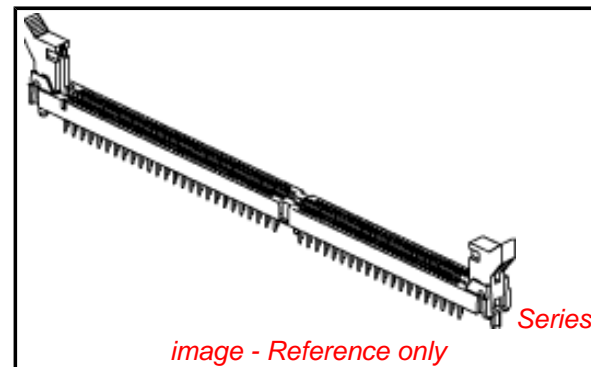

EU RoHS

**ELV and RoHS
 Compliant
 REACH SVHC
 Contains SVHC: No
 Halogen-Free
 Status**

China RoHS

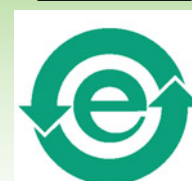

Not Reviewed

**Need more information on product
 environmental compliance?**

Email productcompliance@molex.com
 For a multiple part number RoHS Certificate of
 Compliance, [click here](#)

Please visit the [Contact Us](#) section for any
 non-product compliance questions.

Search Parts in this Series

[71243Series](#)

Mates With

JEDEC MO-167 modules

This document was generated on 04/13/2010

PLEASE CHECK WWW.MOLEX.COM FOR LATEST PART INFORMATION

NOTES:

- CARD SLOT ACCEPTS $.050 \pm .004$ (1.27 ± 0.10) MODULE THICKNESS. (MEASURED OVER P.C. PADS).
- ALL PEGS ARE INTERFERENCE FITS TO PCB UNLESS NOTED ON THE DWG.
- REFER TO PRODUCT SPEC PS-71243-9999 FOR PERFORMANCE SPECIFICATIONS.
- PRODUCT IS PACKAGED IN TRAYS.
- RECOMMENDED MODULE LAYOUT SHALL BE PER JEDEC MO-167.
- RECOMMENDED PLATING ON MODULE PADS: 30 MICROINCH/(0.76 MICROMETER) MINIMUM HARD GOLD (Au) OVER 79 MICROINCH/(2.0 MICROMETER) MINIMUM NICKEL (Ni).
- PRODUCT WILL HAVE DATE CODE STAMPED ON SIDE OF HOUSING.

MATERIALS:

- HOUSING - GLASS FILLED LIQUID CRYSTAL POLYMER (LCP), UL 94V-0, COLOR: BLACK.
- TERMINAL - PHOSPHOR BRONZE
- LATCHES - GLASS FILLED HIGH TEMPERATURE NYLON, UL 94V-0. LATCH AT PIN #1 END IS IVORY COLOR. LATCH AT OPPOSITE END IS BLACK COLOR.

PLATING:

- CONTACT AREA: GOLD (Au) FLASH; THICKNESS=2-10 MICROINCH/(0.05-0.25 MICROMETER), OVER PALLADIUM-NICKEL (Pd-Ni); THICKNESS=30 MICROINCH/(0.76 MICROMETER) MINIMUM.
- SOLDER TAILS: TIN (Sn); THICKNESS=150 MICROINCH/(3.81 MICROMETER) MINIMUM.
- UNDERPLATE: NICKEL (Ni) OVER ENTIRE CONTACT.

NOTE FOR LEAD FREE CONVERSION:

THE PRIMARY SHIPPING CARTON WILL BE LABELED "COMPLIANT TO ROHS DIRECTIVE 2002/95/EC AND ELV ANNEX II OF DIRECTIVE 2000/53/EC". CARTONS WITHOUT THIS LABEL MAY CONTAIN PRODUCT WITH LEAD.

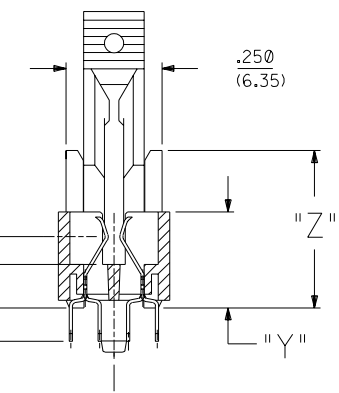
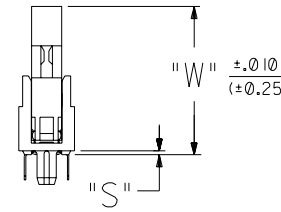
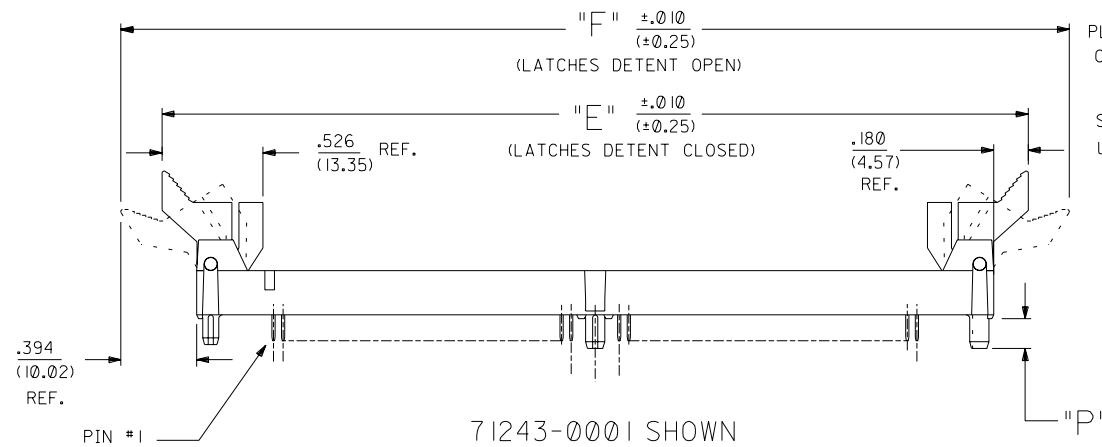
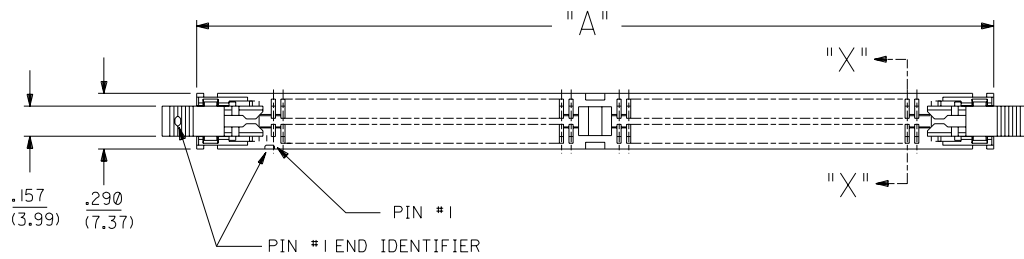

SECTION "X-X"
SCALE 4:1

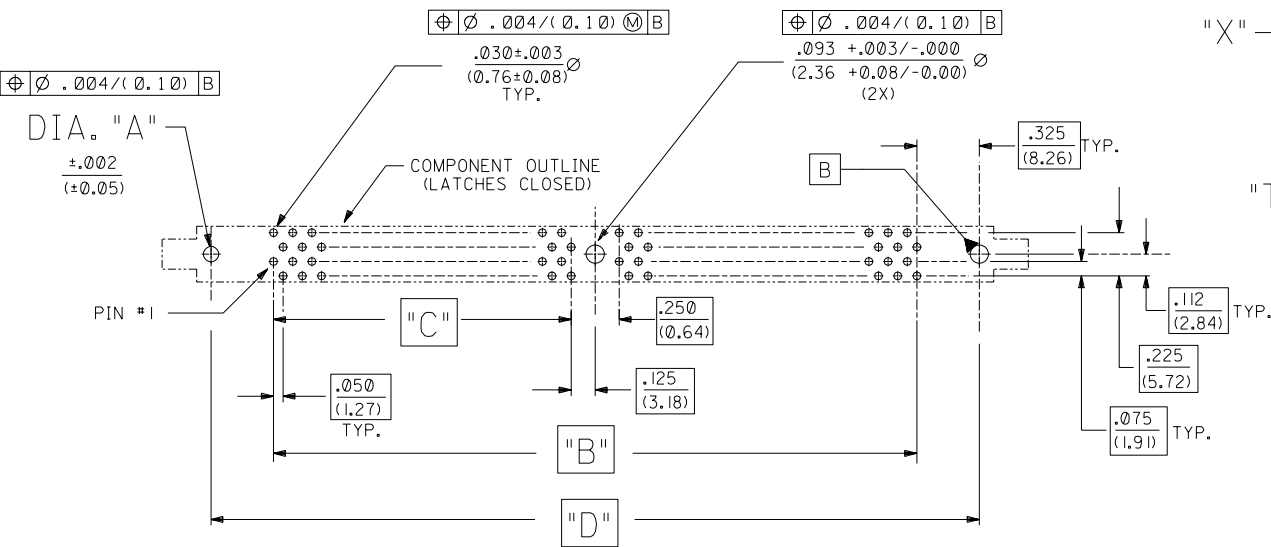

RECOMMENDED P.C. BOARD HOLE PATTERN (CONNECTOR SIDE)

71243				
GI				ADD LEAD FREE NOTE ECR# UDT2004-1732 DMORGAN 04/03/08
G				OBSOLETE 136 CKT. ECR# UDT2000-0947 DMORGAN 00/03/23
F				CHG Sn-Pb THICKNESS ECR# UDT1999-0454 DMORGAN 99/08/09
E				REVISED PER ECR# U61133 96-10-1 LAURX
D				REVISED PER ECR# U60883 3-18-96 JCL
C				REVISED PER ECR# U60836 1-19-96 JCL
B				REVISED PER ECR# U51288 8-4-95 JCL
A				RMVD X REVISED PER ECR# U50617 12-27-94 JCL
2				REVISED PER ECR# U50419 11-7-94 JCL
1				RELEASED PER ECR# U40711 DCB 10/94
MFG.	SH.	REV.	LTR.	REVISIONS
2	G			
1	GI			

DIMENSIONS SHOWN (METRIC) INCH UNLESS OTHERWISE SPECIFIED TOLERANCES: ANGULAR $\pm 1/2^\circ$		REVISE ONLY ON CAD SYSTEM	
3 PLACE $\pm .005$	INCH	---	METRIC
2 PLACE $\pm .01$	$\pm .01$	± 0.13	---
1 PLACE ---	---	± 0.25	---
DRAFT WHERE APPLICABLE MUST REMAIN WITHIN DIMENSIONS			
DRWG. BY: JCL	CHK'D. BY: DCB	FILE NAME: 57124301.DGN	DATE: 10/10/94
APPRD. BY:	SCALE: 2:1	SHEET NO.: 1 OF 2	U.S.A.
SEE CHART		SDA-71243-0 ***	
THIS DRAWING CONTAINS INFORMATION THAT IS PROPRIETARY TO MOLEX INC. AND SHOULD NOT BE USED WITHOUT WRITTEN PERMISSION.			

X = N.T.	ITEM NUMBER 71243	CIRCUIT SIZE	DIA. 'A'	DIM 'A'	DIM 'B'	DIM 'C'	DIM 'D'	DIM 'E'	DIM 'F'	DIM 'G'	DIM 'H'	DIM 'P'	DIM 'S'	DIM 'T'	DIM 'W'	DIM 'X'	DIM 'Y'	DIM 'Z'
	-0001	128	.062 (1.57)	4.150 (105.41)	3.350 (85.09)	1.550 (39.37)	4.000 (101.60)	4.510 (114.56)	4.938 (125.42)	3.850 (97.79)	3.584 (91.03)	.155 (3.94)	.020 (0.51)	.127 (3.23)	.772 (19.61)	.113 (2.87)	.250 (6.35)	.410 (10.41)
	-0002	144	.062 (1.57)	4.550 (115.57)	3.750 (95.25)	1.750 (44.45)	4.400 (111.76)	4.910 (124.71)	5.338 (135.58)	4.250 (107.95)	3.984 (101.19)	.155 (3.94)	.020 (0.51)	.127 (3.23)	.772 (19.61)	.113 (2.87)	.250 (6.35)	.410 (10.41)
	-0003	200	.062 (1.57)	5.950 (151.13)	5.150 (130.81)	2.450 (62.63)	5.800 (147.32)	6.310 (160.28)	6.738 (171.14)	5.650 (143.51)	5.384 (136.75)	.155 (3.94)	.020 (0.51)	.127 (3.23)	.772 (19.61)	.113 (2.87)	.250 (6.35)	.410 (10.41)
	-0004	SEE DRAWING NUMBER SDA-71243-0004																
	-0005	200	.080 (2.03)	5.950 (151.13)	5.150 (130.81)	2.450 (62.63)	5.800 (147.32)	6.310 (160.28)	6.738 (171.14)	5.650 (143.51)	5.384 (136.75)	.140 (3.55)	.035 (0.89)	.112 (2.84)	.787 (19.99)	.128 (3.25)	.265 (6.73)	.425 (10.79)
X	-0006	104	.062 (1.57)	3.550 (90.17)	2.750 (69.85)	1.250 (31.75)	3.400 (86.36)	3.910 (99.31)	4.338 (110.19)	3.250 (82.55)	2.984 (75.79)	.155 (3.94)	.020 (0.51)	.127 (3.23)	.772 (19.61)	.113 (2.87)	.250 (6.35)	.410 (10.41)
	-0008	160	.062 (1.57)	4.950 (125.73)	4.150 (105.41)	1.950 (49.53)	4.800 (121.92)	5.310 (134.88)	5.738 (145.74)	4.650 (118.11)	4.384 (111.35)	.155 (3.94)	.020 (0.51)	.127 (3.23)	.772 (19.61)	.113 (2.87)	.250 (6.35)	.410 (10.41)
	-0009	SEE DRAWING NUMBER SDA-71243-0009																

