



2.5V 1M x 18 pipelined burst synchronous SRAM

Features

- Organization: 1,048,576 x18 bits
- Fast clock speeds to 166 MHz
- Fast clock to data access: 3.5/3.8 ns
- Fast \overline{OE} access time: 3.5/3.8 ns
- Fully synchronous register-to-register operation
- Single-cycle deselect
- Asynchronous output enable control
- Available 100-pin TQFP package
- Individual byte write and global write
- Multiple chip enables for easy expansion
- 2.5V core power supply
- Linear or interleaved burst control
- Snooze mode for reduced power-standby
- Common data inputs and data outputs

Logic block diagram

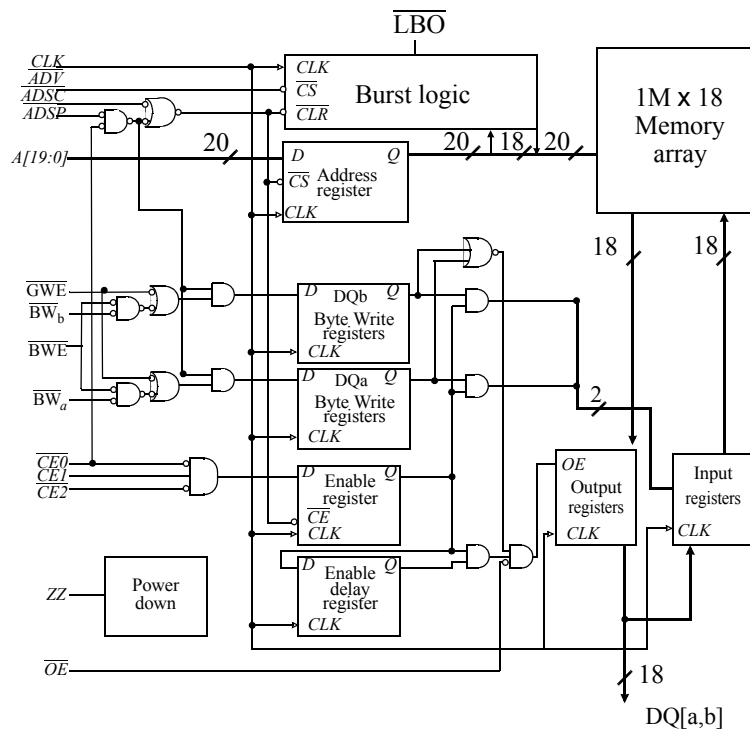

Selection guide

	-166	-133	Units
Minimum cycle time	6	7.5	ns
Maximum clock frequency	166	133	MHz
Maximum clock access time	3.5	3.8	ns
Maximum operating current	290	270	mA
Maximum standby current	85	75	mA
Maximum CMOS standby current (DC)	40	40	mA



16 Mb 2.5V Synchronous SRAM products list^{1,2}

Org	Part Number	Mode	Speed
1MX18	AS7C251MPFS18A	PL-SCD	166/133 MHz
512KX32	AS7C25512PFS32A	PL-SCD	166/133 MHz
512KX36	AS7C25512PFS36A	PL-SCD	166/133 MHz
1MX18	AS7C251MPFD18A	PL-DCD	166/133 MHz
512KX32	AS7C25512PFD32A	PL-DCD	166/133 MHz
512KX36	AS7C25512PFD36A	PL-DCD	166/133 MHz
1MX18	AS7C251MFT18A	FT	7.5/8.5/10 ns
512KX32	AS7C25512FT32A	FT	7.5/8.5/10 ns
512KX36	AS7C25512FT36A	FT	7.5/8.5/10 ns
1MX18	AS7C251MNTD18A	NTD-PL	166/133 MHz
512KX32	AS7C25512NTD32A	NTD-PL	166/133 MHz
512KX36	AS7C25512NTD36A	NTD-PL	166/133 MHz
1MX18	AS7C251MNTF18A	NTD-FT	7.5/8.5/10 ns
512KX32	AS7C25512NTF32A	NTD-FT	7.5/8.5/10 ns
512KX36	AS7C25512NTF36A	NTD-FT	7.5/8.5/10 ns

1 Core Power Supply: VDD = 2.5V ± 0.125V

2 I/O Supply Voltage: VDDQ = 2.5V ± 0.125V

- PL-SCD : Pipelined Burst Synchronous SRAM - Single Cycle Deselect
 PL-DCD : Pipelined Burst Synchronous SRAM - Double Cycle Deselect
 FT : Flow-through Burst Synchronous SRAM
 NTD¹-PL : Pipelined Burst Synchronous SRAM with NTDTM
 NTD-FT : Flow-through Burst Synchronous SRAM with NTDTM

¹NTD: No Turnaround Delay. NTDTM is a trademark of Alliance Semiconductor Corporation. All trademarks mentioned in this document are the property of their respective owners.



Pin designations

Pin configuration for 100-pin TQFP

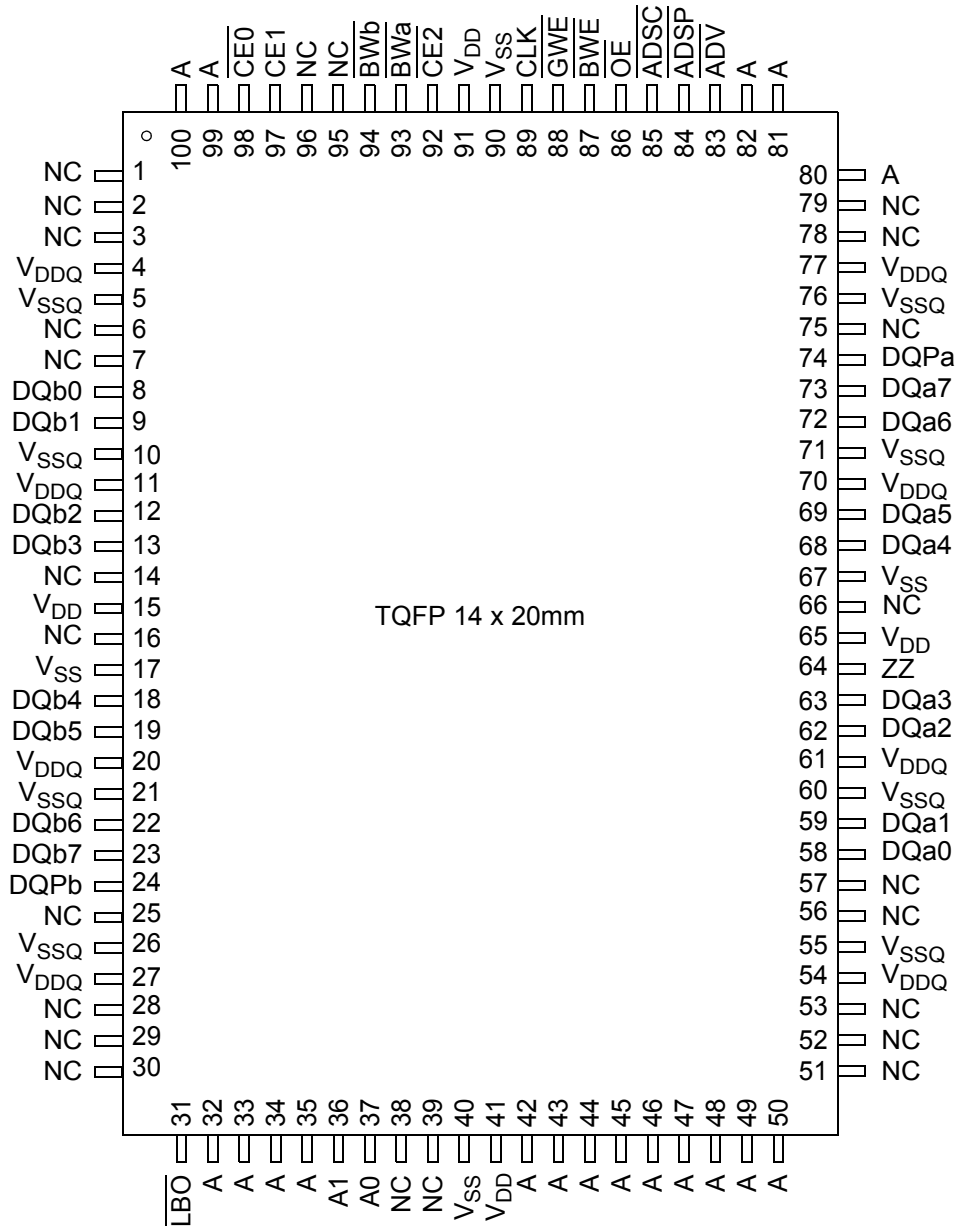



Functional description

The AS7C251MPFS18A is a high-performance CMOS 16-Mbit synchronous Static Random Access Memory (SRAM) device organized as 1,048,576 words X 18 bits and incorporates a two-stage register-register pipeline for highest frequency on any given technology.

Fast cycle times of 6/7.5 ns with clock access times (t_{CD}) of 3.5/3.8 ns enable 166 MHz and 133 MHz bus frequencies. Three chip enable (\overline{CE}) inputs permit easy memory expansion. Burst operation is initiated in one of two ways: the controller address strobe (\overline{ADSC}), or the processor address strobe (\overline{ADSP}). The burst advance pin (\overline{ADV}) allows subsequent internally generated burst addresses.

Read cycles are initiated with \overline{ADSP} (regardless of \overline{WE} and \overline{ADSC}) using the new external address clocked into the on-chip address register when \overline{ADSP} is sampled LOW, the chip enables are sampled active, and the output buffer is enabled with \overline{OE} . In a read operation, the data accessed by the current address registered in the address registers by the positive edge of CLK is carried to the data-out registers and driven on the output pins on the next positive edge of CLK. \overline{ADV} is ignored on the clock edge that samples \overline{ADSP} asserted, but it is sampled on all subsequent clock edges. Address is incremented internally for the next access of the burst when \overline{ADV} is sampled LOW and both address strobes are HIGH. Burst mode is selectable with the \overline{LBO} input. With \overline{LBO} unconnected or driven HIGH, burst operations use an interleaved count sequence. With \overline{LBO} driven LOW, the device uses a linear count sequence.

Write cycles are performed by disabling the output buffers with \overline{OE} and asserting a write command. A global write enable \overline{GWE} writes all 18 bits regardless of the state of individual $\overline{BW[a,b]}$ inputs. Alternately, when \overline{GWE} is HIGH, one or more bytes may be written by asserting \overline{BWE} and the appropriate individual byte \overline{BWn} signals.

\overline{BWn} is ignored on the clock edge that samples \overline{ADSP} LOW, but it is sampled on all subsequent clock edges. Output buffers are disabled when \overline{BWn} is sampled LOW, regardless of \overline{OE} . Data is clocked into the data input register when \overline{BWn} is sampled LOW. Address is incremented internally to the next burst address if \overline{BWn} and \overline{ADV} are sampled LOW.

Read or write cycles may also be initiated with \overline{ADSC} instead of \overline{ADSP} . The differences between cycles initiated with \overline{ADSC} and \overline{ADSP} are as follows:

- \overline{ADSP} must be sampled HIGH when \overline{ADSC} is sampled LOW to initiate a cycle with \overline{ADSC} .
- \overline{WE} signals are sampled on the clock edge that samples \overline{ADSC} LOW (and \overline{ADSP} HIGH).
- Master chip enable $\overline{CE0}$ blocks \overline{ADSP} , but not \overline{ADSC} .

The AS7C251MPFS18A family operates from a core 2.5V power supply. These devices are available in a 100-pin TQFP package.

TQFP capacitance

Parameter	Symbol	Test conditions	Min	Max	Unit
Input capacitance	C_{IN}^*	$V_{IN} = 0V$	-	5	pF
I/O capacitance	$C_{I/O}^*$	$V_{OUT} = 0V$	-	7	pF

* Guaranteed not tested

TQFP thermal resistance

Description	Conditions		Symbol	Typical	Units
Thermal resistance (junction to ambient) ¹	Test conditions follow standard test methods and procedures for measuring thermal impedance, per EIA/JESD51	1-layer	θ_{JA}	40	°C/W
		4-layer	θ_{JA}	22	°C/W
Thermal resistance (junction to top of case) ¹			θ_{JC}	8	°C/W

¹ This parameter is sampled



Signal descriptions

Signal	I/O	Properties	Description
CLK	I	CLOCK	Clock. All inputs except OE, ZZ, and LBO are synchronous to this clock.
A,A0,A1	I	SYNC	Address. Sampled when all chip enables are active and when ADSC or ADSP are asserted.
DQ[a,b]	I/O	SYNC	Data. Driven as output when the chip is enabled and when OE is active.
$\overline{CE0}$	I	SYNC	Master chip enable. Sampled on clock edges when ADSP or ADSC is active. When CE0 is inactive, ADSP is blocked. Refer to the "Synchronous truth table" for more information.
CE1, $\overline{CE2}$	I	SYNC	Synchronous chip enables. Active HIGH and active LOW, respectively. Sampled on clock edges when ADSC is active or when $\overline{CE0}$ and ADSP are active.
\overline{ADSP}	I	SYNC	Address strobe processor. Asserted LOW to load a new bus address or to enter standby mode.
\overline{ADSC}	I	SYNC	Address strobe controller. Asserted LOW to load a new address or to enter standby mode.
\overline{ADV}	I	SYNC	Advance. Asserted LOW to continue burst read/write.
\overline{GWE}	I	SYNC	Global write enable. Asserted LOW to write all 32/36 and 18 bits. When HIGH, BWE and BW[a,b] control write enable.
\overline{BWE}	I	SYNC	Byte write enable. Asserted LOW with GWE HIGH to enable effect of BW[a,b] inputs.
$\overline{BW[a,b]}$	I	SYNC	Write enables. Used to control write of individual bytes when GWE is HIGH and BWE is LOW. If any of $\overline{BW[a,b]}$ is active with GWE HIGH and \overline{BWE} LOW, the cycle is a write cycle. If all $\overline{BW[a,b]}$ are inactive, the cycle is a read cycle.
\overline{OE}	I	ASYNCR	Asynchronous output enable. I/O pins are driven when OE is active and the chip is in read mode.
\overline{LBO}	I	STATIC	Selects Burst mode. When tied to V _{DD} or left floating, device follows interleaved Burst order. When driven LOW, device follows linear Burst order. <i>This signal is internally pulled High.</i>
ZZ	I	ASYNCR	Sleep. Places device in LOW power mode; data is retained. Connect to GND if unused.
NC	-	-	No connect

Snooze Mode

SNOOZE MODE is a low current, power-down mode in which the device is deselected and current is reduced to I_{SB2}. The duration of SNOOZE MODE is dictated by the length of time the ZZ is in a High state.

The ZZ pin is an asynchronous, active high input that causes the device to enter SNOOZE MODE.

When the ZZ pin becomes a logic High, I_{SB2} is guaranteed after the time t_{ZZI} is met. After entering SNOOZE MODE, all inputs except ZZ is disabled and all outputs go to High-Z. Any operation pending when entering SNOOZE MODE is not guaranteed to successfully complete. Therefore, SNOOZE MODE (READ or WRITE) must not be initiated until valid pending operations are completed. Similarly, when exiting SNOOZE MODE during t_{PU}, only a DESELECT or READ cycle should be given while the SRAM is transitioning out of SNOOZE MODE.



Write enable truth table (per byte)

Function	$\overline{\text{GWE}}$	$\overline{\text{BWE}}$	$\overline{\text{BWa}}$	$\overline{\text{BWb}}$
Write all bytes (a, b)	L	X	X	X
	H	L	L	L
Write byte a	H	L	L	H
Write byte b	H	L	H	L
Read	H	H	X	X
	H	L	H	H

Key: X = don't care; L = low; H = high; $\overline{\text{BWE}}$, $\overline{\text{BWn}}$ = internal write signal

Asynchronous Truth Table

Operation	ZZ	$\overline{\text{OE}}$	I/O Status
Snooze mode	H	X	High-Z
Read	L	L	Dout
	L	H	High-Z
Write	L	X	Din, High-Z
Deselected	L	X	High-Z

Notes:

1. X means "Don't Care"
2. ZZ pin is pulled down internally
3. For write cycles that follows read cycles, the output buffers must be disabled with $\overline{\text{OE}}$, otherwise data bus contention will occur.
4. Snooze mode means power down state of which stand-by current does not depend on cycle times
5. Deselected means power down state of which stand-by current depends on cycle times

Burst sequence table

Interleaved burst address ($\overline{\text{LBO}} = 1$)					Linear burst address ($\overline{\text{LBO}} = 0$)				
	A1 A0	A1 A0	A1 A0	A1 A0		A1 A0	A1 A0	A1 A0	A1 A0
Starting Address	0 0	0 1	1 0	1 1	Starting Address	0 0	0 1	1 0	1 1
First Increment	0 1	0 0	1 1	1 0	First Increment	0 1	1 0	1 1	0 0
Second Increment	1 0	1 1	0 0	0 1	Second Increment	1 0	1 1	0 0	0 1
Third Increment	1 1	1 0	0 1	0 0	Third Increment	1 1	1 0	0 1	1 0

Synchronous truth table^[4]

$\overline{CE0}^1$	CE1	$\overline{CE2}$	\overline{ADSP}	\overline{ADSC}	\overline{ADV}	$\overline{WRITE}^{[2]}$	\overline{OE}	Address accessed	CLK	Operation	DQ
H	X	X	X	L	X	X	X	NA	L to H	Deselect	Hi-Z
L	L	X	L	X	X	X	X	NA	L to H	Deselect	Hi-Z
L	L	X	H	L	X	X	X	NA	L to H	Deselect	Hi-Z
L	X	H	L	X	X	X	X	NA	L to H	Deselect	Hi-Z
L	X	H	H	L	X	X	X	NA	L to H	Deselect	Hi-Z
L	H	L	L	X	X	X	L	External	L to H	Begin read	Q
L	H	L	L	X	X	X	H	External	L to H	Begin read	Hi-Z
L	H	L	H	L	X	H	L	External	L to H	Begin read	Q
L	H	L	H	L	X	H	H	External	L to H	Begin read	Hi-Z
X	X	X	H	H	L	H	L	Next	L to H	Continue read	Q
X	X	X	H	H	L	H	H	Next	L to H	Continue read	Hi-Z
X	X	X	H	H	H	H	L	Current	L to H	Suspend read	Q
X	X	X	H	H	H	H	H	Current	L to H	Suspend read	Hi-Z
H	X	X	X	H	L	H	L	Next	L to H	Continue read	Q
H	X	X	X	H	L	H	H	Next	L to H	Continue read	Hi-Z
H	X	X	X	H	H	H	L	Current	L to H	Suspend read	Q
H	X	X	X	H	H	H	H	Current	L to H	Suspend read	Hi-Z
L	H	L	H	L	X	L	X	External	L to H	Begin write	D ³
X	X	X	H	H	L	L	X	Next	L to H	Continue write	D
H	X	X	X	H	L	L	X	Next	L to H	Continue write	D
X	X	X	H	H	H	L	X	Current	L to H	Suspend write	D
H	X	X	X	H	H	L	X	Current	L to H	Suspend write	D

1 X = don't care, L = low, H = high

2 For \overline{WRITE} , L means any one or more byte write enable signals (\overline{BWA} or \overline{BWb}) and \overline{BWE} are LOW or \overline{GWE} is LOW. \overline{WRITE} = HIGH for all \overline{BWx} , \overline{BWE} , \overline{GWE} HIGH. See "Snooze Mode," on page 5 for more information.

3 For write operation following a READ, \overline{OE} must be HIGH before the input data set up time and held HIGH throughout the input hold time

4 ZZ pin is always Low.



Absolute maximum ratings

Parameter	Symbol	Min	Max	Unit
Power supply voltage relative to GND	V_{DD}, V_{DDQ}	-0.3	+3.6	V
Input voltage relative to GND (input pins)	V_{IN}	-0.3	$V_{DD} + 0.3$	V
Input voltage relative to GND (I/O pins)	V_{IN}	-0.3	$V_{DDQ} + 0.3$	V
Power dissipation	P_D	-	1.8	W
DC output current	I_{OUT}	-	20 mA	mA
Storage temperature	T_{stg}	-65	+150	°C
Temperature under bias	T_{bias}	-65	+135	°C

Note: Stresses greater than those listed in this table may cause permanent damage to the device. This is a stress rating only, and functional operation of the device at these or any other conditions outside those indicated in the operational sections of this specification is not implied. Exposure to absolute maximum rating conditions may affect reliability.

Recommended operating conditions

Parameter	Symbol	Min	Nominal	Max	Unit
Supply voltage for inputs	V_{DD}	2.375	2.5	2.625	V
Supply voltage for I/O	V_{DDQ}	2.375	2.5	2.625	V
Ground supply	V_{SS}	0	0	0	V



DC electrical characteristics

Parameter	Sym	Conditions	Min	Max	Unit
Input leakage current [†]	I _{LI}	V _{DD} = Max, 0V ≤ V _{IN} ≤ V _{DD}	-2	2	μA
Output leakage current	I _{LO}	OE ≥ V _{IH} , V _{DD} = Max, 0V ≤ V _{OUT} ≤ V _{DDQ}	-2	2	μA
Input high (logic 1) voltage	V _{IH}	Address and control pins	1.7*	V _{DD} +0.3	V
		I/O pins	1.7*	V _{DDQ} +0.3	V
Input low (logic 0) voltage	V _{IL}	Address and control pins	-0.3**	0.7	V
		I/O pins	-0.3**	0.7	V
Output high voltage	V _{OH}	I _{OH} = -4 mA, V _{DDQ} = 2.375V	1.7	-	V
Output low voltage	V _{OL}	I _{OL} = 8 mA, V _{DDQ} = 2.625V	-	0.7	V

[†] LBO and ZZ pins have an internal pull-up or pull-down, and input leakage = ±10 μA.

*V_{IH} max < V_{DD} + 1.5V for pulse width less than 0.2 X t_{CYC}

**V_{IL} min = -1.5 for pulse width less than 0.2 X t_{CYC}

I_{DD} operating conditions and maximum limits

Parameter	Sym	Conditions	-166	-133	Unit
Operating power supply current ¹	I _{CC}	$\overline{CE0} \leq V_{IL}$, CE1 ≥ V _{IH} , $\overline{CE2} \leq V_{IL}$, f = f _{Max} , I _{OUT} = 0 mA, ZZ ≤ V _{IL}	290	270	mA
Standby power supply current	I _{SB}	All V _{IN} ≤ 0.2V or ≥ V _{DD} - 0.2V, Deselected, f = f _{Max} , ZZ ≤ V _{IL}	85	75	mA
	I _{SB1}	Deselected, f = 0, ZZ ≤ 0.2V, all V _{IN} ≤ 0.2V or ≥ V _{DD} - 0.2V	40	40	
	I _{SB2}	Deselected, f = f _{Max} , ZZ ≥ V _{DD} - 0.2V, all V _{IN} ≤ V _{IL} or ≥ V _{IH}	40	40	

¹ I_{CC} given with no output loading. I_{CC} increases with faster cycle times and greater output loading.



Timing characteristics over operating range

Parameter	Sym	-166		-133		Unit	Notes ¹
		Min	Max	Min	Max		
Clock frequency	f_{Max}	–	166	–	133	MHz	
Cycle time	t_{CYC}	6	–	7.5	–	ns	
Clock access time	t_{CD}	–	3.5	–	3.8	ns	
Output enable low to data valid	t_{OE}	–	3.5	–	3.8	ns	
Clock high to output low Z	t_{LZC}	0	–	0	–	ns	2,3,4
Data output invalid from clock high	t_{OH}	1.5	–	1.5	–	ns	2
Output enable low to output low Z	t_{LZOE}	0	–	0	–	ns	2,3,4
Output enable high to output high Z	t_{HZOE}	–	3.5	–	3.8	ns	2,3,4
Clock high to output high Z	t_{HZC}	–	3.5	–	3.8	ns	2,3,4
Output enable high to invalid output	t_{OHOE}	0	–	0	–	ns	
Clock high pulse width	t_{CH}	2.4	–	2.4	–	ns	5
Clock low pulse width	t_{CL}	2.3	–	2.4	–	ns	5
Address setup to clock high	t_{AS}	1.5	–	1.5	–	ns	6
Data setup to clock high	t_{DS}	1.5	–	1.5	–	ns	6
Write setup to clock high	t_{WS}	1.5	–	1.5	–	ns	6,7
Chip select setup to clock high	t_{CSS}	1.5	–	1.5	–	ns	6,8
Address hold from clock high	t_{AH}	0.5	–	0.5	–	ns	6
Data hold from clock high	t_{DH}	0.5	–	0.5	–	ns	6
Write hold from clock high	t_{WH}	0.5	–	0.5	–	ns	6,7
Chip select hold from clock high	t_{CSH}	0.5	–	0.5	–	ns	6,8
\overline{ADV} setup to clock high	t_{ADVS}	1.5	–	1.5	–	ns	6
\overline{ADSP} setup to clock high	t_{ADSPS}	1.5	–	1.5	–	ns	6
\overline{ADSC} setup to clock high	t_{ADSCS}	1.5	–	1.5	–	ns	6
\overline{ADV} hold from clock high	t_{ADVH}	0.5	–	0.5	–	ns	6
\overline{ADSP} hold from clock high	t_{ADSPH}	0.5	–	0.5	–	ns	6
\overline{ADSC} hold from clock high	t_{ADSCH}	0.5	–	0.5	–	ns	6

¹ See “Notes” on page 16.

Snooze Mode Electrical Characteristics

Description	Conditions	Symbol	Min	Max	Units
Current during Snooze Mode	$ZZ \geq V_{IH}$	I_{SB2}		40	mA
ZZ active to input ignored		t_{PDS}	2		cycle
ZZ inactive to input sampled		t_{PUS}	2		cycle
ZZ active to SNOOZE current		t_{ZZI}		2	cycle
ZZ inactive to exit SNOOZE current		t_{RZZI}	0		cycle



Key to switching waveforms

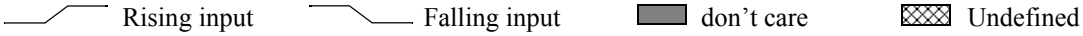

Timing waveform of read cycle

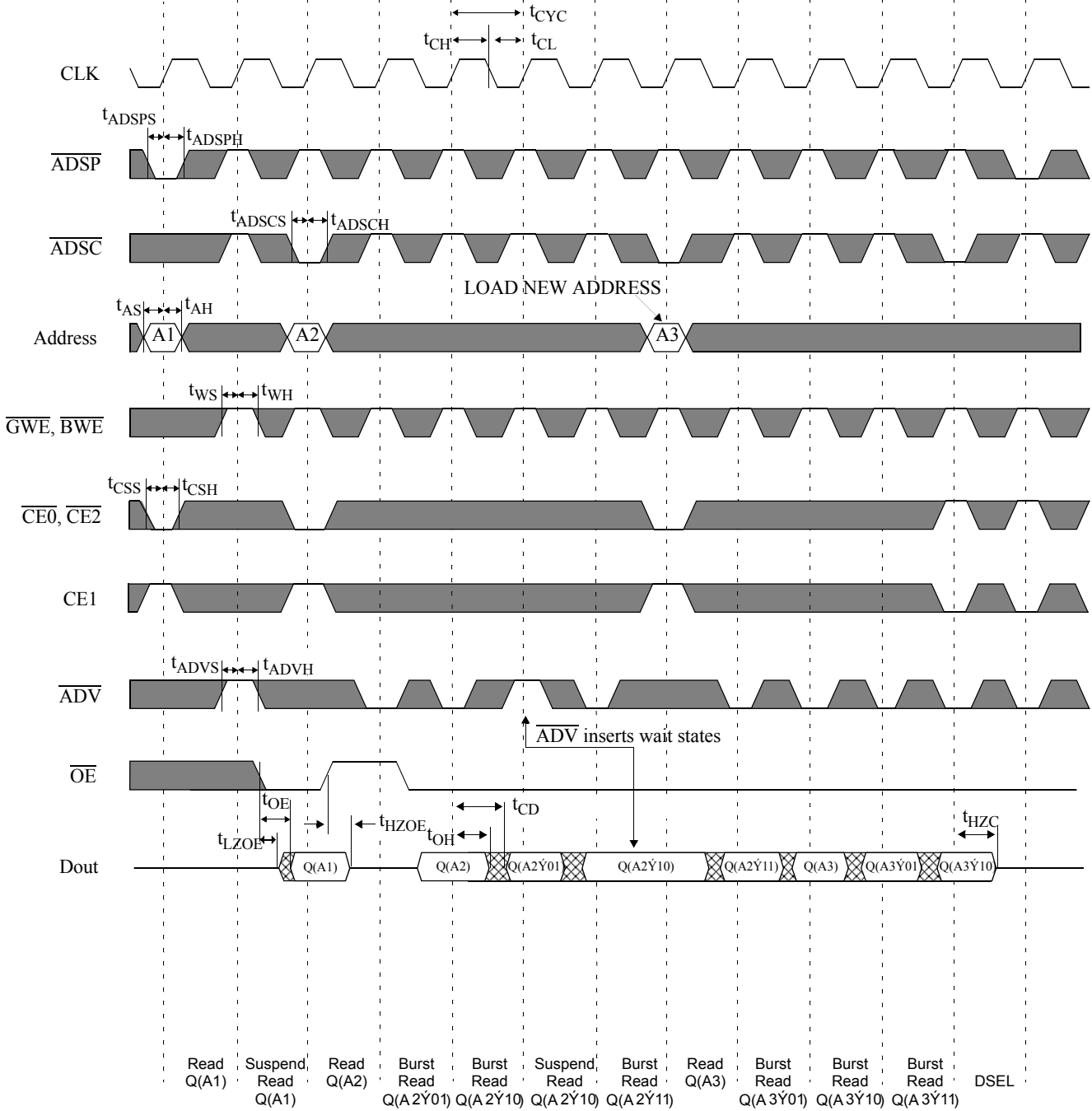

Note: $\dot{Y} = \text{XOR}$ when $\overline{\text{LBO}} = \text{high/no connect}$; $\dot{Y} = \text{ADD}$ when $\overline{\text{LBO}} = \text{low}$. $\overline{\text{BW}}[a:d]$ is don't care.



Timing waveform of write cycle

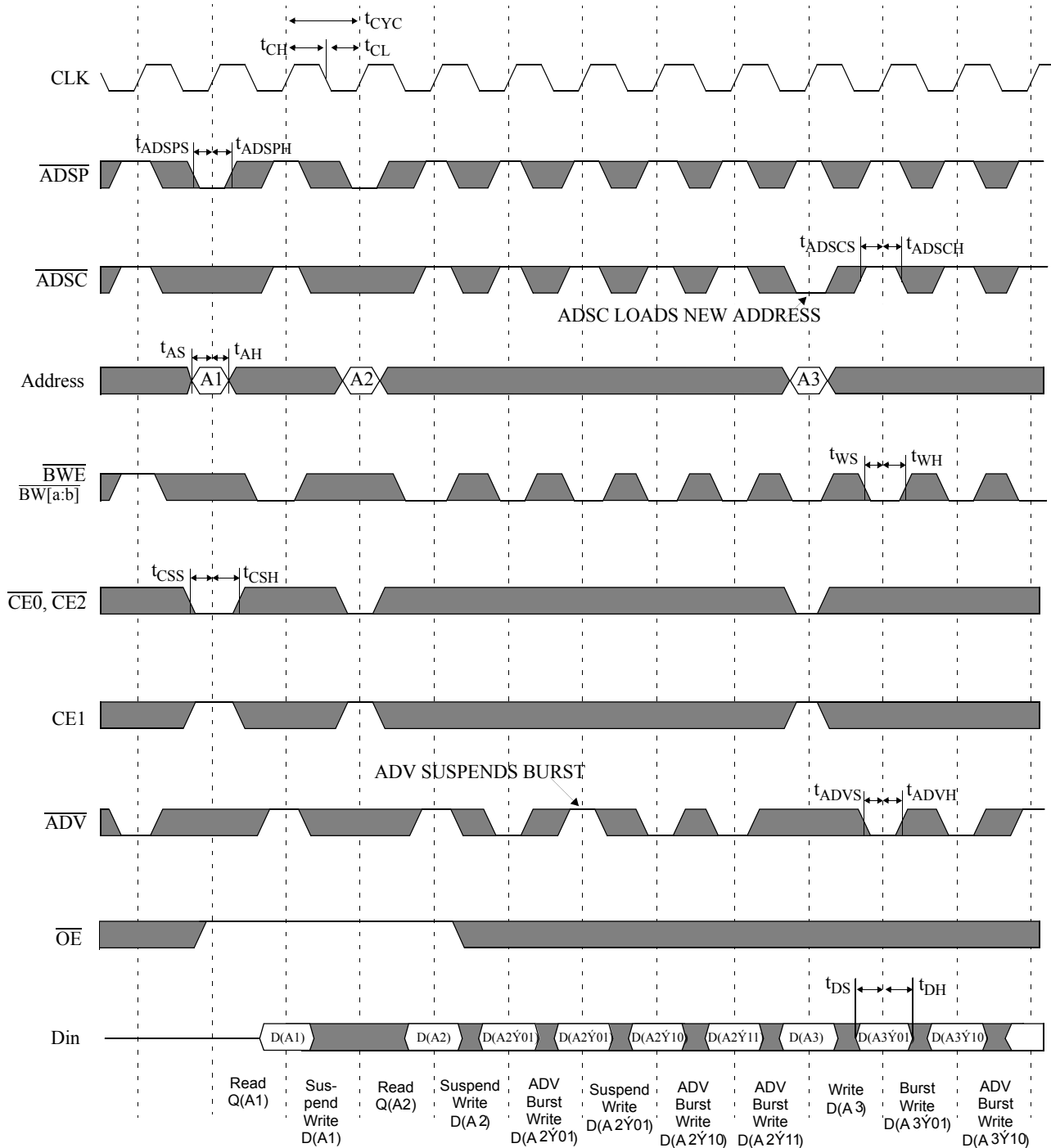

Note: $\dot{Y} = \text{XOR}$ when $\overline{LBO} = \text{high/no connect}$; $\dot{Y} = \text{ADD}$ when $\overline{LBO} = \text{low}$.



Timing waveform of read/write cycle (ADSP Controlled; ADSC High)

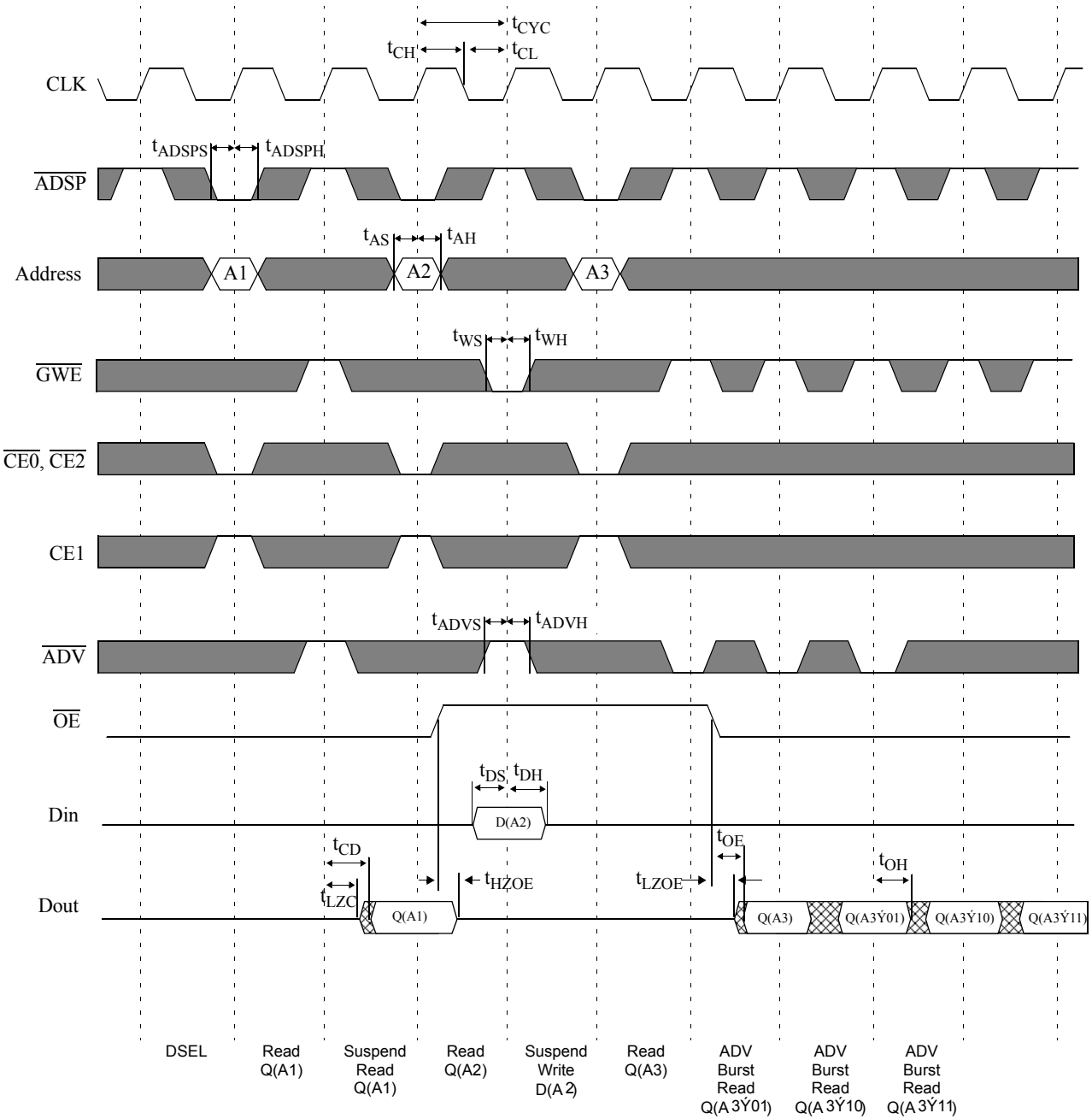

Note: \dot{Y} = XOR when $\overline{LB0}$ = high/no connect; \dot{Y} = ADD when $\overline{LB0}$ = low.



Timing waveform of read/write cycle(ADSC controlled, ADSP = HIGH)

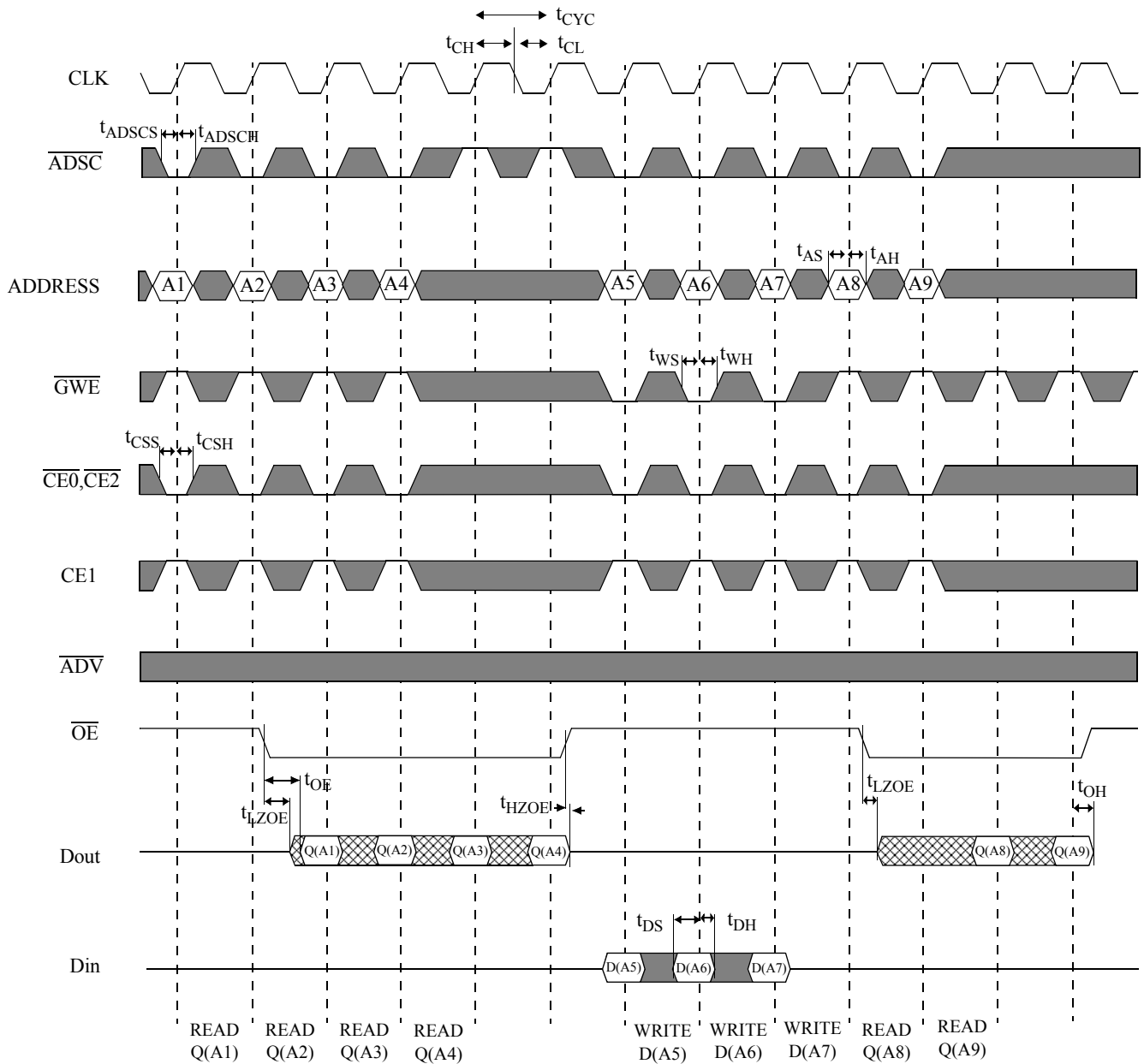



Timing waveform of power down cycle

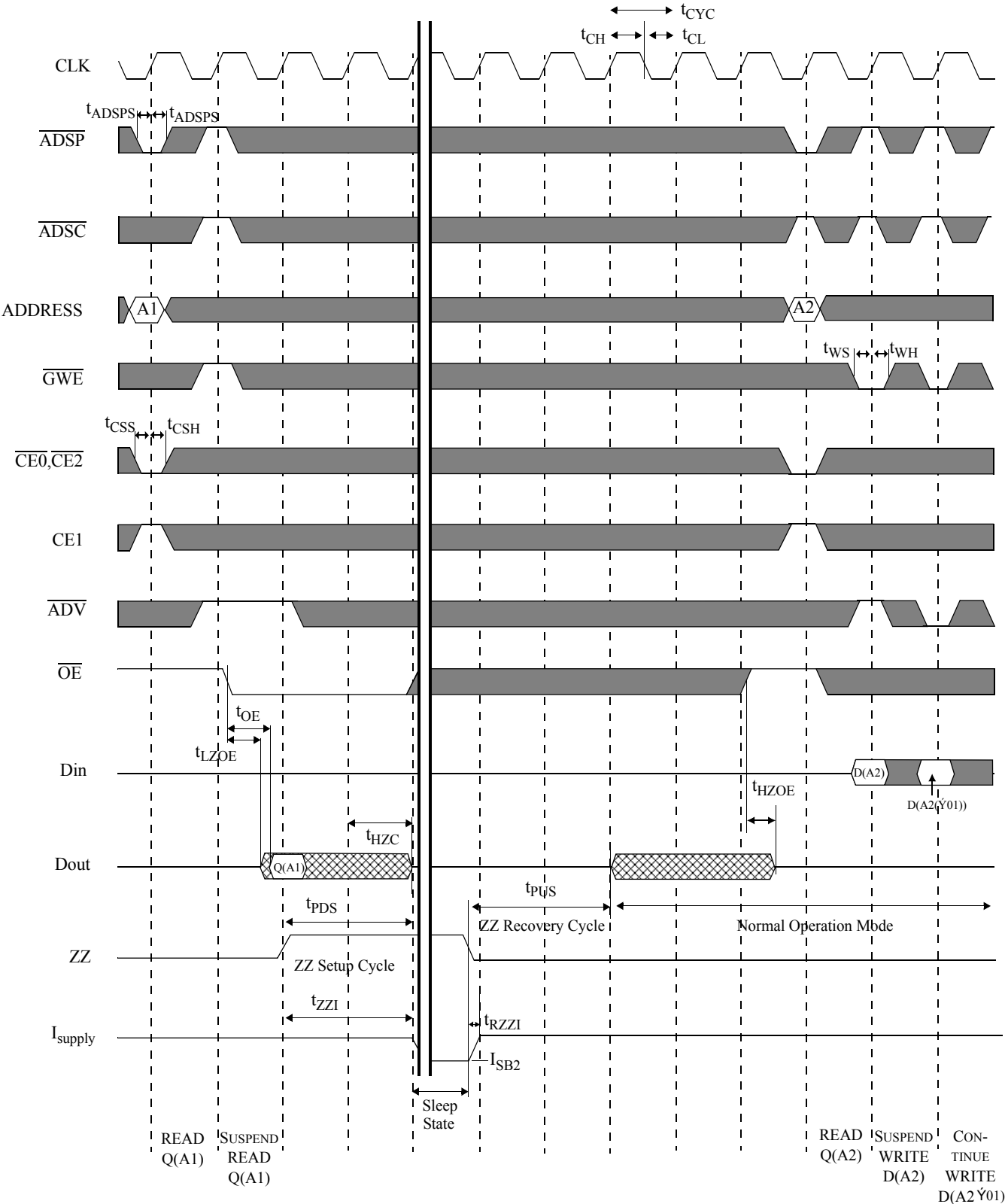



AC test conditions

- Output load: For t_{LZC} , t_{LZOE} , t_{HZOE} , t_{HZC} , see Figure C. For all others, see Figure B.
- Input pulse level: GND to 2.5V. See Figure A.
- Input rise and fall time (measured at 0.25V and 2.25V): 2 ns. See Figure A.
- Input and output timing reference levels: 1.25V.

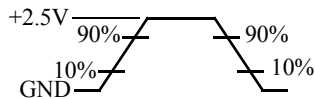

Figure A: Input waveform

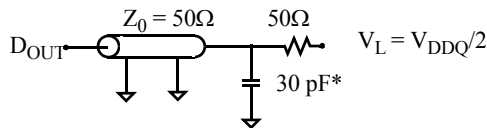

Figure B: Output load (A)

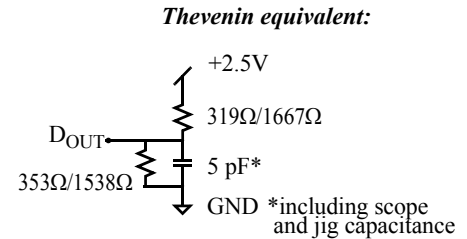

Figure C: Output load(B)

Notes

- 1 For test conditions, see “AC Test Conditions”, Figures A, B, and C.
- 2 This parameter is measured with output load condition in Figure C.
- 3 This parameter is sampled but not 100% tested.
- 4 t_{HZOE} is less than t_{LZOE} , and t_{HZC} is less than t_{LZC} at any given temperature and voltage.
- 5 t_{CH} is measured as high above V_{IH} , and t_{CL} is measured as low below V_{IL} .
- 6 This is a synchronous device. All addresses must meet the specified setup and hold times for all rising edges of CLK. All other synchronous inputs must meet the setup and hold times for all rising edges of CLK when chip is enabled.
- 7 Write refers to \overline{GWE} , \overline{BWE} , and $\overline{BW[a,b]}$.
- 8 Chip select refers to $\overline{CE0}$, $CE1$, and $\overline{CE2}$.



Package dimensions

100-pin TQFP (quad flat pack)

	TQFP	
	Min	Max
A1	0.05	0.15
A2	1.35	1.45
b	0.22	0.38
c	0.09	0.20
D	13.90	14.10
E	19.90	20.10
e	0.65 nominal	
Hd	15.85	16.15
He	21.80	22.20
L	0.45	0.75
L1	1.00 nominal	
α	0°	7°

Dimensions in millimeters

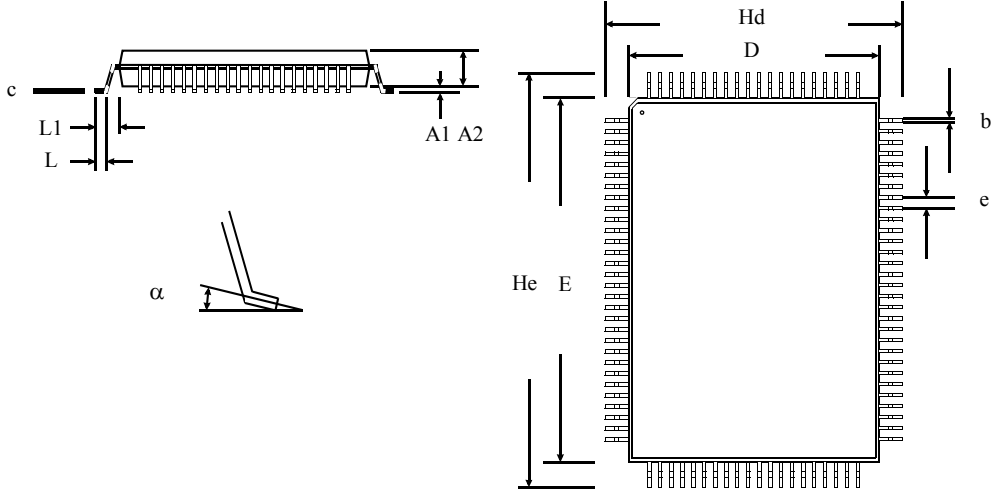



Ordering information

Package & Width	-166	-133
TQFP x18	AS7C251MPFS18A-166TQC	AS7C251MPFS18A-133TQC
	AS7C251MPFS18A-166TQI	AS7C251MPFS18A-133TQI

Note:

Add 'N' to the above part numbers for Lead Free Parts (Ex. AS7C251MPFS18A-166TQCN)

Part numbering guide

AS7C	25	1M	PF	S	18	A	-XXX	TQ	C/I	X
1	2	3	4	5	6	7	8	9	10	11

- Alliance Semiconductor SRAM prefix
- Operating voltage: 25 = 2.5V
- Organization: 1M
- Pipelined mode
- Deselect: S = single cycle deselect
- Organization: 18 = x18
- Production version: A = first production version
- Clock speed (MHz)
- Package type: TQ = TQFP
- Operating temperature: C = commercial (0° C to 70° C); I = industrial (-40° C to 85° C)
- N = Lead Free Part



Alliance Semiconductor Corporation
2575, Augustine Drive,
Santa Clara, CA 95054
Tel: 408 - 855 - 4900
Fax: 408 - 855 - 4999
www.alsc.com

Copyright © Alliance Semiconductor
All Rights Reserved
Part Number: AS7C251MPFS18A
Document Version: v. 2.2

© Copyright 2003 Alliance Semiconductor Corporation. All rights reserved. Our three-point logo, our name and Intelliwatt are trademarks or registered trademarks of Alliance. All other brand and product names may be the trademarks of their respective companies. Alliance reserves the right to make changes to this document and its products at any time without notice. Alliance assumes no responsibility for any errors that may appear in this document. The data contained herein represents Alliance's best data and/or estimates at the time of issuance. Alliance reserves the right to change or correct this data at any time, without notice. If the product described herein is under development, significant changes to these specifications are possible. The information in this product data sheet is intended to be general descriptive information for potential customers and users, and is not intended to operate as, or provide, any guarantee or warranty to any user or customer. Alliance does not assume any responsibility or liability arising out of the application or use of any product described herein, and disclaims any express or implied warranties related to the sale and/or use of Alliance products including liability or warranties related to fitness for a particular purpose, merchantability, or infringement of any intellectual property rights, except as express agreed to in Alliance's Terms and Conditions of Sale (which are available from Alliance). All sales of Alliance products are made exclusively according to Alliance's Terms and Conditions of Sale. The purchase of products from Alliance does not convey a license under any patent rights, copyrights; mask works rights, trademarks, or any other intellectual property rights of Alliance or third parties. Alliance does not authorize its products for use as critical components in life-supporting systems where a malfunction or failure may reasonably be expected to result in significant injury to the user, and the inclusion of Alliance products in such life-supporting systems implies that the manufacturer assumes all risk of such use and agrees to indemnify Alliance against all claims arising from such use.