

Cavity Bandpass Filter

ZVBP-8250+

50Ω 8025 to 8475 MHz

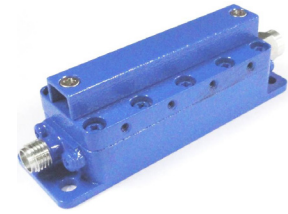

CASE STYLE: PN2113

The Big Deal

- Low insertion loss, 1dB typical
- High rejection
- Fast roll-off
- Connectorized package
- Small size

Product Overview

ZVBP-8250+ is a 50Ω cavity filter for X band. Frequency band of this filter is used in satellite and radar applications..

Key Features

Feature	Advantages
Low loss in passband	This filter has low loss in passband
Sharp rejection	This filter has sharp rejection in stopband
Connectorized package and small size	Connectorized package is easy to interface with other devices and well suited for test setups. Package size is so small

Notes

- A. Performance and quality attributes and conditions not expressly stated in this specification document are intended to be excluded and do not form a part of this specification document.
B. Electrical specifications and performance data contained in this specification document are based on Mini-Circuit's applicable established test performance criteria and measurement instructions.
C. The parts covered by this specification document are subject to Mini-Circuits standard limited warranty and terms and conditions (collectively, "Standard Terms"); Purchasers of this part are entitled to the rights and benefits contained therein. For a full statement of the Standard Terms and the exclusive rights and remedies thereunder, please visit Mini-Circuits' website at www.minicircuits.com/MCLStore/terms.jsp



Bandpass Filter

ZVBP-8250+

50Ω 8025 to 8475 MHz

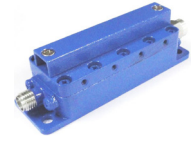

CASE STYLE: PN2113
 Connectors Model
 SMA-F ZVBP-8250-S+
 SMA-M

Features

- Low insertion loss, 1.0 dB typical
- High rejection
- Fast roll-off
- Connectorized package
- Small size

Applications

- Satellite
- Radar

Electrical Specifications at 25°C

Parameter	F#	Frequency (MHz)	Min.	Typ.	Max.	Unit	
Pass Band	Center Frequency	-	-	8250	-	MHz	
	Insertion Loss	F1-F2	8025-8475	-	1.0	1.5	dB
	VSWR	F1-F2	8025-8475	-	1.5	1.7	:1
Stop Band, Lower	Insertion Loss	DC-F3	DC - 7650	20	28	-	dB
	VSWR	DC-F3	DC - 7650	-	40	-	:1
Stop Band, Upper	Insertion Loss	F4-F5	8925-11000	20	28	-	dB
	VSWR	F4-F5	8925-11000	-	40	-	:1

Maximum Ratings

Operating Temperature	-40°C to 85°C
Storage Temperature	-55°C to 100°C
RF Power Input	10 W max.

Permanent damage may occur if any of these limits are exceeded.

Functional Schematic

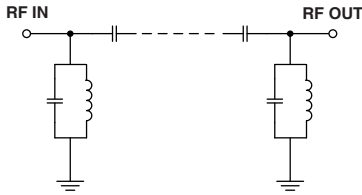

Typical Frequency Response

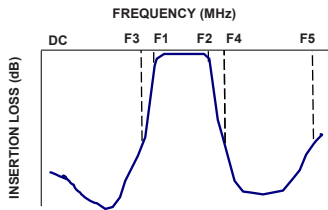

Typical Performance Data at 25°C

Frequency (MHz)	Insertion Loss (dB)	VSWR (:1)	Frequency (MHz)	Group Delay (nsec)
10	76.87	434.30	8025	2.22
500	105.19	108.58	8050	1.98
3000	101.78	124.09	8075	1.86
7000	58.19	64.35	8100	1.78
7650	29.90	57.91	8125	1.75
7770	20.80	44.55	8150	1.71
7940	3.18	3.63	8175	1.67
7950	2.42	2.81	8200	1.63
8000	0.85	1.05	8225	1.60
8025	0.81	1.26	8250	1.57
8250	0.71	1.31	8260	1.57
8475	0.76	1.18	8275	1.57
8500	0.79	1.02	8300	1.58
8570	2.45	2.84	8325	1.60
8580	3.07	3.50	8350	1.63
8780	20.10	41.37	8375	1.65
8925	28.85	66.82	8400	1.68
9300	43.24	75.53	8425	1.72
9800	54.20	96.51	8450	1.79
11000	64.38	96.51	8475	1.90

+RoHS Compliant

The +Suffix identifies RoHS Compliance. See our web site for RoHS Compliance methodologies and qualifications

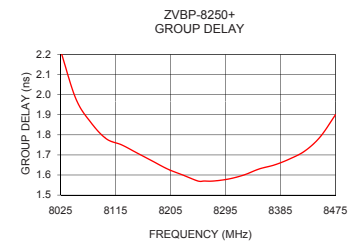
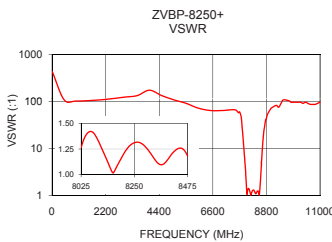
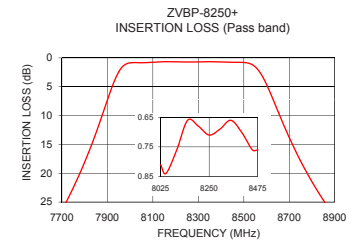
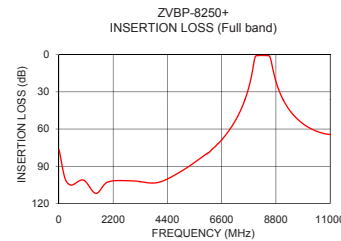

Notes

- Performance and quality attributes and conditions not expressly stated in this specification document are intended to be excluded and do not form a part of this specification document.
- Electrical specifications and performance data contained in this specification document are based on Mini-Circuit's applicable established test performance criteria and measurement instructions.
- The parts covered by this specification document are subject to Mini-Circuits standard limited warranty and terms and conditions (collectively, "Standard Terms"); Purchasers of this part are entitled to the rights and benefits contained therein. For a full statement of the Standard Terms and the exclusive rights and remedies thereunder, please visit Mini-Circuits' website at www.minicircuits.com/MCLStore/terms.jsp



Coaxial Connections

INPUT	SMA-FEMALE
OUTPUT	SMA-MALE

Outline Drawing

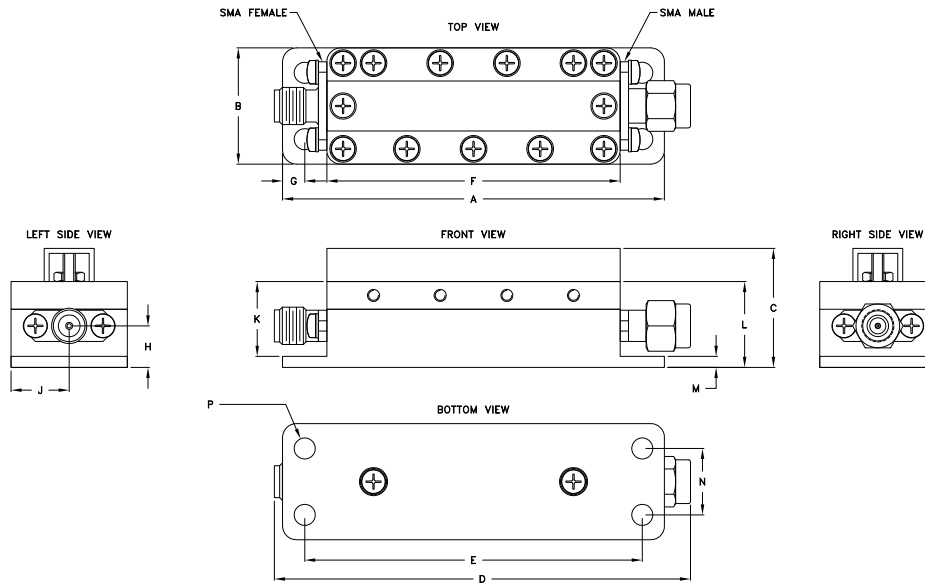

Outline Dimensions ($\frac{\text{inch}}{\text{mm}}$)

A	B	C	D	E	F	G	H
2.717	.827	.847	2.960	2.402	2.087	.158	.295
69.01	21.01	21.51	75.18	61.01	53.01	4.01	7.49
J	K	L	M	N	P	Wt.	
.413	.532	.610	.079	.472	.150	grams	
10.49	13.51	15.49	2.01	11.99	3.81	56	

Notes

- A. Performance and quality attributes and conditions not expressly stated in this specification document are intended to be excluded and do not form a part of this specification document.
 B. Electrical specifications and performance data contained in this specification document are based on Mini-Circuit's applicable established test performance criteria and measurement instructions.
 C. The parts covered by this specification document are subject to Mini-Circuits standard limited warranty and terms and conditions (collectively, "Standard Terms"); Purchasers of this part are entitled to the rights and benefits contained therein. For a full statement of the Standard Terms and the exclusive rights and remedies thereunder, please visit Mini-Circuits' website at www.minicircuits.com/MCLStore/terms.jsp