

## Optocoupler, Phototransistor Output (Dual, Quad Channel)

Dual Channel

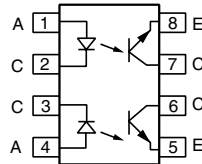

Quad Channel

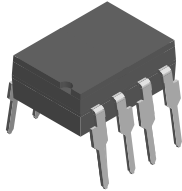
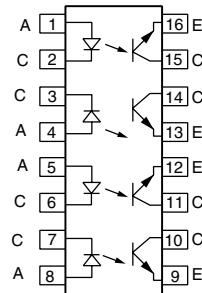
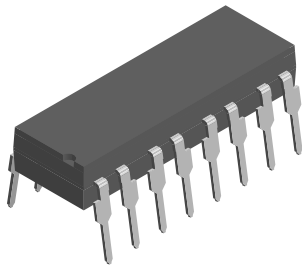

1179012

### DESCRIPTION

The ILD1/2/5/ILQ1/2/5 are optically coupled isolated pairs employing GaAs infrared LEDs and silicon NPN phototransistor. Signal information, including a DC level, can be transmitted by the drive while maintaining a high degree of electrical isolation between input and output. The ILD1/2/5/ILQ1/2/5 are especially designed for driving medium-speed logic and can be used to eliminate troublesome ground loop and noise problems. Also these couplers can be used to replace relays and transformers in many digital interface applications such as CTR modulation. The ILD1/2/5 has two isolated channels in a single DIP package and the ILQ1/2/5 has four isolated channels per package..

### FEATURES

- Current transfer ratio at  $I_F = 10 \text{ mA}$
- Isolation test voltage,  $5300 V_{RMS}$
- Lead (Pb)-free component
- Component in accordance to RoHS 2002/95/EC and WEEE 2002/96/EC



**RoHS**  
COMPLIANT

### AGENCY APPROVALS

- UL1577, file no. E52744 system code H or J, double protection
- CSA 93751
- BSI IEC 60950 IEC 60065
- DIN EN 60747-5-2 (VDE 0884)/DIN EN 60747-5-5 pending available with option 1
- FIMKO

### ORDER INFORMATION

PART	REMARKS
ILD1	CTR > 20 %, DIP-8
ILQ1	CTR > 20 %, DIP-16
ILD2	CTR > 100 %, DIP-8
ILQ2	CTR > 100 %, DIP-16
ILD5	CTR > 50 %, DIP-8
ILQ5	CTR > 50 %, DIP-16
ILD1-X007	CTR > 20 %, SMD-8 (option 7)

# ILD1/ILD2/ILD5/ILQ1/ILQ2/ILQ5



Vishay Semiconductors

Optocoupler, Phototransistor Output  
(Dual, Quad Channel)

ORDER INFORMATION	
PART	REMARKS
ILD1-X009	CTR > 20 %, SMD-8 (option 9)
ILD2-X006	CTR > 100 %, DIP-8 400 mil (option 6)
ILD2-X007	CTR > 100 %, SMD-8 (option 7)
ILD2-X009	CTR > 100 %, SMD-8 (option 9)
ILD5-X009	CTR > 50 %, SMD-8 (option 9)
ILQ1-X009	CTR > 20 %, SMD-16 (option 9)
ILQ2-X009	CTR > 100 %, SMD-16 (option 9)

## Note

For additional information on the available options refer to option information.

ABSOLUTE MAXIMUM RATINGS <sup>(1)</sup>					
PARAMETER	TEST CONDITION	PART	SYMBOL	VALUE	UNIT
<b>INPUT</b>					
Reverse voltage			$V_R$	6.0	V
Forward current			$I_F$	60	mA
Surge current			$I_{FSM}$	2.5	A
Power dissipation			$P_{diss}$	100	mW
Derate linearly from 25 °C				1.3	mW/°C
<b>OUTPUT</b>					
Collector emitter reverse voltage		ILD1	$V_{CER}$	50	V
		ILQ1	$V_{CER}$	50	V
		ILD2	$V_{CER}$	70	V
		ILQ2	$V_{CER}$	70	V
		ILD5	$V_{CER}$	70	V
		ILQ5	$V_{CER}$	70	V
Collector current	$t < 1.0$ ms		$I_C$	50	mA
			$I_C$	400	mA
Power dissipation			$P_{diss}$	200	mW
Derate linearly from 25 °C				2.6	mW/°C
<b>COUPLER</b>					
Isolation test voltage (between emitter and detector referred to standard climate 25 °C/50 % RH, DIN 50014)			$V_{ISO}$	5300	$V_{RMS}$
Creepage distance				≥ 7.0	mm
Clearance distance				≥ 7.0	mm
Isolation resistance	$V_{IO} = 500$ V, $T_{amb} = 25$ °C		$R_{IO}$	$10^{12}$	$\Omega$
	$V_{IO} = 500$ V, $T_{amb} = 100$ °C		$R_{IO}$	$10^{11}$	$\Omega$
Package power dissipation			$P_{tot}$	250	mW
Derate linearly from 25 °C				3.3	mW/°C
Storage temperature			$T_{stg}$	- 40 to + 150	°C
Operating temperature			$T_{amb}$	- 40 to + 100	°C
Junction temperature			$T_j$	100	°C
Soldering temperature <sup>(2)</sup>	2.0 mm from case bottom		$T_{sld}$	260	°C

## Notes

<sup>(1)</sup>  $T_{amb} = 25$  °C, unless otherwise specified.

Stresses in excess of the absolute maximum ratings can cause permanent damage to the device. Functional operation of the device is not implied at these or any other conditions in excess of those given in the operational sections of this document. Exposure to absolute maximum ratings for extended periods of the time can adversely affect reliability.

<sup>(2)</sup> Refer to reflow profile for soldering conditions for surface mounted devices (SMD). Refer to wave profile for soldering conditions for through hole devices (DIP).



ELECTRICAL CHARACTERISTICS						
PARAMETER	TEST CONDITION	SYMBOL	MIN.	TYP.	MAX.	UNIT
<b>INPUT</b>						
Forward voltage	$I_F = 60 \text{ mA}$	$V_F$		1.25	1.65	V
Reverse current	$V_R = 6.0 \text{ V}$	$I_R$		0.01	10	$\mu\text{A}$
Capacitance	$V_R = 0 \text{ V}, f = 1.0 \text{ MHz}$	$C_O$		25		pF
Thermal resistance, junction to lead		$T_{thJL}$		750		K/W
<b>OUTPUT</b>						
Collector emitter capacitance	$V_{CE} = 5.0 \text{ V}, f = 1.0 \text{ MHz}$	$C_{CE}$		6.8		pF
Collector emitter leakage current	$V_{VCE} = 10 \text{ V}$	$I_{CEO}$		5.0	50	nA
Saturation voltage, collector emitter	$I_C = 1.0 \text{ mA}, I_B = 20 \mu\text{A}$	$V_{CESAT}$		0.25	0.4	V
DC forward current gain	$V_{CE} = 10 \text{ V}, I_B = 20 \mu\text{A}$	$h_{FE}$	200	650	1800	
DC forward current gain saturated	$V_{CE} = 0.4 \text{ V}, I_B = 20 \mu\text{A}$	$h_{FEsat}$	120	400	600	
Thermal resistance, junction to lead		$R_{thJl}$		500		K/W
<b>COUPLER</b>						
Capacitance (input to output)	$V_{IO} = 0 \text{ V}, f = 1.0 \text{ MHz}$	$C_{IO}$		0.8		pF

**Note**

$T_{amb} = 25 \text{ }^\circ\text{C}$ , unless otherwise specified.

Minimum and maximum values are testing requirements. Typical values are characteristics of the device and are the result of engineering evaluation. Typical values are for information only and are not part of the testing requirements.

CURRENT TRANSFER RATIO							
PARAMETER	TEST CONDITION	PART	SYMBOL	MIN.	TYP.	MAX.	UNIT
Current transfer ratio (collector emitter saturated)	$I_F = 10 \text{ mA}, V_{CE} = 0.4 \text{ V}$	ILD1	$CTR_{CEsat}$		75		%
		ILQ1	$CTR_{CEsat}$		75		%
		ILD2	$CTR_{CEsat}$		170		%
		ILQ2	$CTR_{CEsat}$		170		%
		ILD5	$CTR_{CEsat}$		100		%
		ILQ5	$CTR_{CEsat}$		100		%
Current transfer ratio (collector emitter)	$I_F = 10 \text{ mA}, V_{CE} = 10 \text{ V}$	ILD1	$CTR_{CE}$	20	80	300	%
		ILQ1	$CTR_{CE}$	20	80	300	%
		ILD2	$CTR_{CE}$	100	200	500	%
		ILQ2	$CTR_{CE}$	100	200	500	%
		ILD5	$CTR_{CE}$	50	130	400	%
		ILQ5	$CTR_{CE}$	50	130	400	%

SWITCHING CHARACTERISTICS							
PARAMETER	TEST CONDITION	PART	SYMBOL	MIN.	TYP.	MAX.	UNIT
<b>NON-SATURATED</b>							
Current	$V_{CE} = 5.0 \text{ V}, R_L = 75 \Omega, 50 \% \text{ of } V_{PP}$	ILD1	$I_F$		20		mA
		ILQ1	$I_F$		20		mA
		ILD2	$I_F$		5.0		mA
		ILQ2	$I_F$		5.0		mA
		ILD5	$I_F$		10		mA
		ILQ5	$I_F$		10		mA

# ILD1/ILD2/ILD5/ILQ1/ILQ2/ILQ5



Vishay Semiconductors Optocoupler, Phototransistor Output  
(Dual, Quad Channel)

SWITCHING CHARACTERISTICS							
PARAMETER	TEST CONDITION	PART	SYMBOL	MIN.	TYP.	MAX.	UNIT
<b>NON-SATURATED</b>							
Delay	$V_{CE} = 5.0\text{ V}, R_L = 75\ \Omega, 50\% \text{ of } V_{PP}$	ILD1	$t_D$		0.8		$\mu\text{s}$
		ILQ1	$t_D$		0.8		$\mu\text{s}$
		ILD2	$t_D$		1.7		$\mu\text{s}$
		ILQ2	$t_D$		1.7		$\mu\text{s}$
		ILD5	$t_D$		1.7		$\mu\text{s}$
		ILQ5	$t_D$		1.7		$\mu\text{s}$
Rise time	$V_{CE} = 5.0\text{ V}, R_L = 75\ \Omega, 50\% \text{ of } V_{PP}$	ILD1	$t_r$		1.9		$\mu\text{s}$
		ILQ1	$t_r$		1.9		$\mu\text{s}$
		ILD2	$t_r$		2.6		$\mu\text{s}$
		ILQ2	$t_r$		2.6		$\mu\text{s}$
		ILD5	$t_r$		2.6		$\mu\text{s}$
		ILQ5	$t_r$		2.6		$\mu\text{s}$
Storage	$V_{CE} = 5.0\text{ V}, R_L = 75\ \Omega, 50\% \text{ of } V_{PP}$	ILD1	$t_s$		0.2		$\mu\text{s}$
		ILQ1	$t_s$		0.2		$\mu\text{s}$
		ILD2	$t_s$		0.4		$\mu\text{s}$
		ILQ2	$t_s$		0.4		$\mu\text{s}$
		ILD5	$t_s$		0.4		$\mu\text{s}$
		ILQ5	$t_s$		0.4		$\mu\text{s}$
Fall time	$V_{CE} = 5.0\text{ V}, R_L = 75\ \Omega, 50\% \text{ of } V_{PP}$	ILD1	$t_f$		1.4		$\mu\text{s}$
		ILQ1	$t_f$		1.4		$\mu\text{s}$
		ILD2	$t_f$		2.2		$\mu\text{s}$
		ILQ2	$t_f$		2.2		$\mu\text{s}$
		ILD5	$t_f$		2.2		$\mu\text{s}$
		ILQ5	$t_f$		2.2		$\mu\text{s}$
Propagation H to L	$V_{CE} = 5.0\text{ V}, R_L = 75\ \Omega, 50\% \text{ of } V_{PP}$	ILD1	$t_{PHL}$		0.7		$\mu\text{s}$
		ILQ1	$t_{PHL}$		0.7		$\mu\text{s}$
		ILD2	$t_{PHL}$		1.2		$\mu\text{s}$
		ILQ2	$t_{PHL}$		1.2		$\mu\text{s}$
		ILD5	$t_{PHL}$		1.1		$\mu\text{s}$
		ILQ5	$t_{PHL}$		1.1		$\mu\text{s}$
Propagation L to H	$V_{CE} = 5.0\text{ V}, R_L = 75\ \Omega, 50\% \text{ of } V_{PP}$	ILD1	$t_{PLH}$		1.4		$\mu\text{s}$
		ILQ1	$t_{PLH}$		1.4		$\mu\text{s}$
		ILD2	$t_{PLH}$		2.3		$\mu\text{s}$
		ILQ2	$t_{PLH}$		2.3		$\mu\text{s}$
		ILD5	$t_{PLH}$		2.5		$\mu\text{s}$
		ILQ5	$t_{PLH}$		2.5		$\mu\text{s}$
<b>SATURATED</b>							
Current	$V_{CE} = 0.4\text{ V}, R_L = 1.0\text{ k}\Omega, V_{CC} = 5.0\text{ V}, V_{TH} = 1.5\text{ V}$	ILD1	$I_F$		20		mA
		ILQ1	$I_F$		20		mA
		ILD2	$I_F$		5.0		mA
		ILQ2	$I_F$		5.0		mA
		ILD5	$I_F$		10		mA
		ILQ5	$I_F$		10		mA
Delay	$V_{CE} = 0.4\text{ V}, R_L = 1.0\text{ k}\Omega, V_{CC} = 5.0\text{ V}, V_{TH} = 1.5\text{ V}$	ILD1	$t_D$		0.8		$\mu\text{s}$
		ILQ1	$t_D$		0.8		$\mu\text{s}$
		ILD2	$t_D$		1.0		$\mu\text{s}$
		ILQ2	$t_D$		1.0		$\mu\text{s}$
		ILD5	$t_D$		1.7		$\mu\text{s}$
		ILQ5	$t_D$		1.7		$\mu\text{s}$



SWITCHING CHARACTERISTICS							
PARAMETER	TEST CONDITION	PART	SYMBOL	MIN.	TYP.	MAX.	UNIT
<b>SATURATED</b>							
Rise time	$V_{CE} = 0.4\text{ V}$ , $R_L = 1.0\text{ k}\Omega$ , $V_{CC} = 5.0\text{ V}$ , $V_{TH} = 1.5\text{ V}$	ILD1	$t_r$		1.2		$\mu\text{s}$
		ILQ1	$t_r$		1.2		$\mu\text{s}$
		ILD2	$t_r$		2.0		$\mu\text{s}$
		ILQ2	$t_r$		2.0		$\mu\text{s}$
		ILD5	$t_r$		7.0		$\mu\text{s}$
		ILQ5	$t_r$		7.0		$\mu\text{s}$
Storage	$V_{CE} = 0.4\text{ V}$ , $R_L = 1.0\text{ k}\Omega$ , $V_{CC} = 5.0\text{ V}$ , $V_{TH} = 1.5\text{ V}$	ILD1	$t_s$		7.4		$\mu\text{s}$
		ILQ1	$t_s$		7.4		$\mu\text{s}$
		ILD2	$t_s$		5.4		$\mu\text{s}$
		ILQ2	$t_s$		5.4		$\mu\text{s}$
		ILD5	$t_s$		4.6		$\mu\text{s}$
		ILQ5	$t_s$		4.6		$\mu\text{s}$
Fall time	$V_{CE} = 0.4\text{ V}$ , $R_L = 1.0\text{ k}\Omega$ , $V_{CC} = 5.0\text{ V}$ , $V_{TH} = 1.5\text{ V}$	ILD1	$t_f$		7.6		$\mu\text{s}$
		ILQ1	$t_f$		7.6		$\mu\text{s}$
		ILD2	$t_f$		13.5		$\mu\text{s}$
		ILQ2	$t_f$		13.5		$\mu\text{s}$
		ILD5	$t_f$		20		$\mu\text{s}$
		ILQ5	$t_f$		20		$\mu\text{s}$
Propagation H to L	$V_{CE} = 0.4\text{ V}$ , $R_L = 1.0\text{ k}\Omega$ , $V_{CC} = 5.0\text{ V}$ , $V_{TH} = 1.5\text{ V}$	ILD1	$t_{PHL}$		1.6		$\mu\text{s}$
		ILQ1	$t_{PHL}$		1.6		$\mu\text{s}$
		ILD2	$t_{PHL}$		5.4		$\mu\text{s}$
		ILQ2	$t_{PHL}$		5.4		$\mu\text{s}$
		ILD5	$t_{PHL}$		2.6		$\mu\text{s}$
		ILQ5	$t_{PHL}$		2.6		$\mu\text{s}$
Propagation L to H	$V_{CE} = 0.4\text{ V}$ , $R_L = 1.0\text{ k}\Omega$ , $V_{CC} = 5.0\text{ V}$ , $V_{TH} = 1.5\text{ V}$	ILD1	$t_{PLH}$		8.6		$\mu\text{s}$
		ILQ1	$t_{PLH}$		8.6		$\mu\text{s}$
		ILD2	$t_{PLH}$		7.4		$\mu\text{s}$
		ILQ2	$t_{PLH}$		7.4		$\mu\text{s}$
		ILD5	$t_{PLH}$		7.2		$\mu\text{s}$
		ILQ5	$t_{PLH}$		7.2		$\mu\text{s}$

COMMON MODE TRANSIENT IMMUNITY						
PARAMETER	TEST CONDITION	SYMBOL	MIN.	TYP.	MAX.	UNIT
Common mode rejection, output high	$V_{CM} = 50\text{ V}_{P-P}$ , $R_L = 1.0\text{ k}\Omega$ , $I_F = 0\text{ mA}$	$CM_H$		5000		$\text{V}/\mu\text{s}$
Common mode rejection, output low	$V_{CM} = 50\text{ V}_{P-P}$ , $R_L = 1.0\text{ k}\Omega$ , $I_F = 10\text{ mA}$	$CM_L$		5000		$\text{V}/\mu\text{s}$
Common mode coupling capacitance		$C_{CM}$		0.01		$\text{pF}$

## TYPICAL CHARACTERISTICS

$T_{amb} = 25\text{ }^{\circ}\text{C}$ , unless otherwise specified

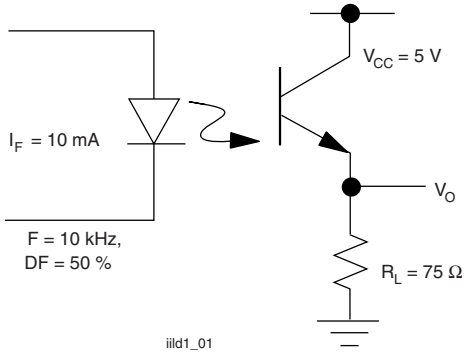
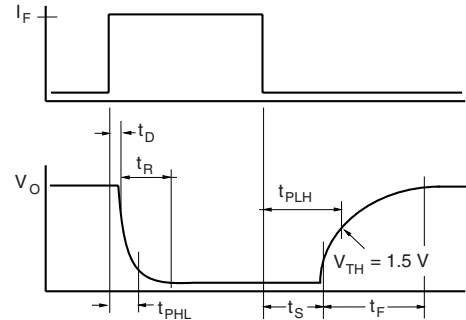
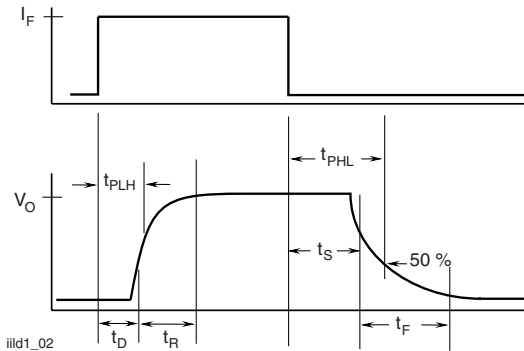

Fig. 1 - Non-Saturated Switching Schematic



iiid1\_04

Fig. 4 - Saturated Switching Timing



iiid1\_02

Fig. 2 - Non-Saturated Switching Timing

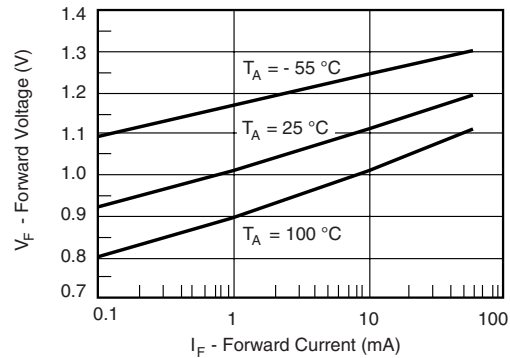

iiid1\_05

Fig. 5 - Normalized Non-Saturated and Saturated CTR vs. LED Current

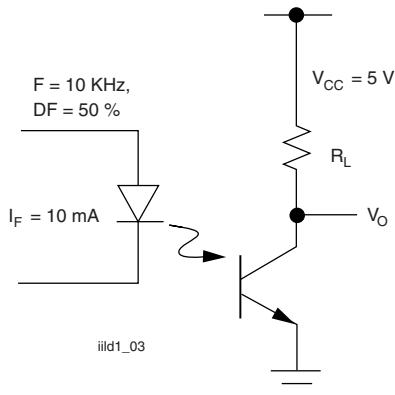

iiid1\_03

Fig. 3 - Saturated Switching Schematic

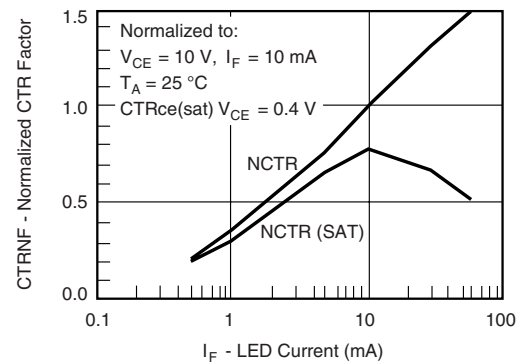

iiid1\_06

Fig. 6 - Normalized Non-Saturated and Saturated CTR vs. LED Current

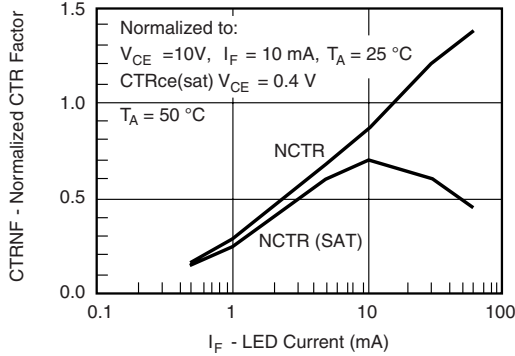

iiid1\_07

Fig. 7 - Normalized Non-Saturated and Saturated CTR vs. LED Current

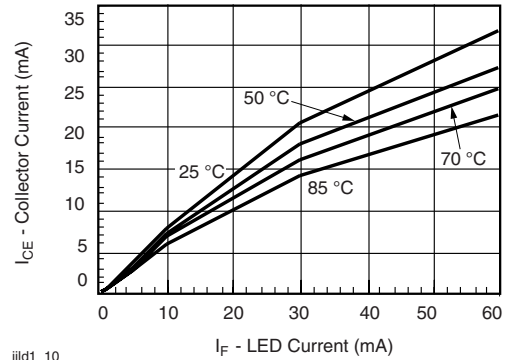

iiid1\_10

Fig. 10 - Collector Emitter Current vs. Temperature and LED Current

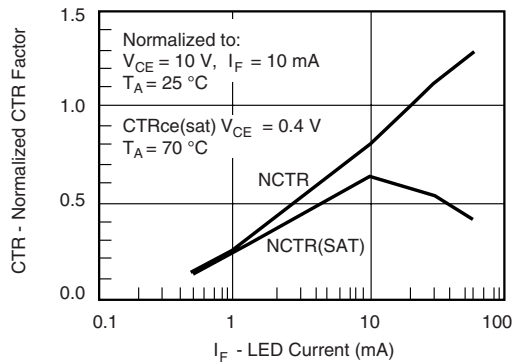

iiid1\_08

Fig. 8 - Normalized Non-Saturated and Saturated CTR vs. LED Current

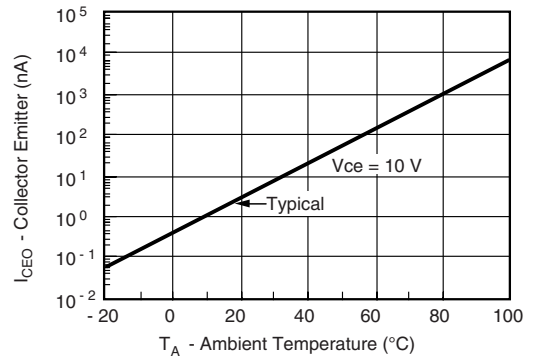

iiid1\_11

Fig. 11 - Collector Emitter Leakage Current vs. Temperature

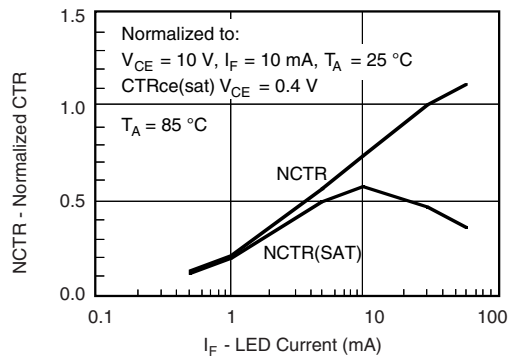

iiid1\_09

Fig. 9 - Normalized Non-Saturated and Saturated CTR vs. LED Current

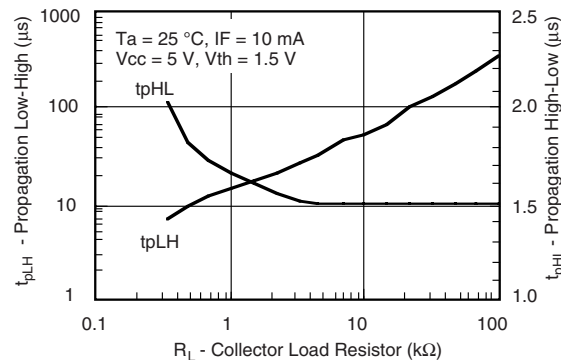

iiid1\_12

Fig. 12 - Propagation Delay vs. Collector Load Resistor

# ILD1/ILD2/ILD5/ILQ1/ILQ2/ILQ5



Vishay Semiconductors Optocoupler, Phototransistor Output  
(Dual, Quad Channel)

## PACKAGE DIMENSIONS in inches (millimeters)

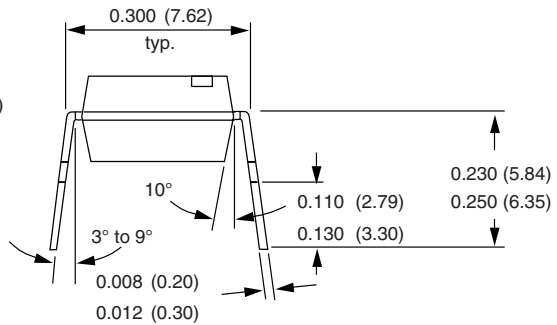
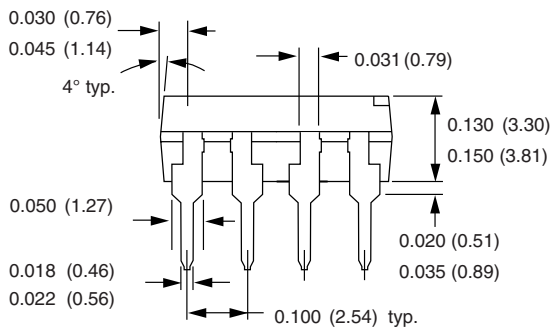
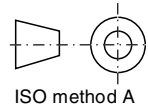
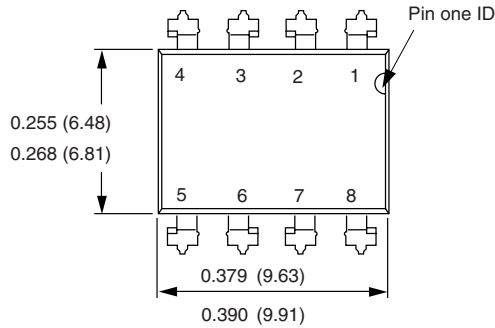

i178006

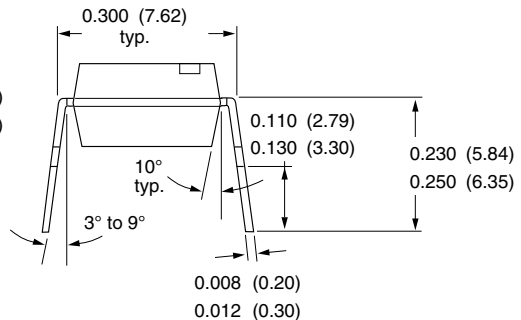
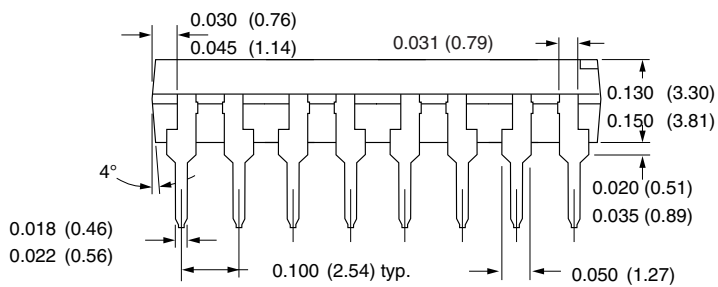
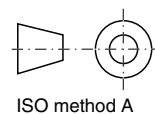
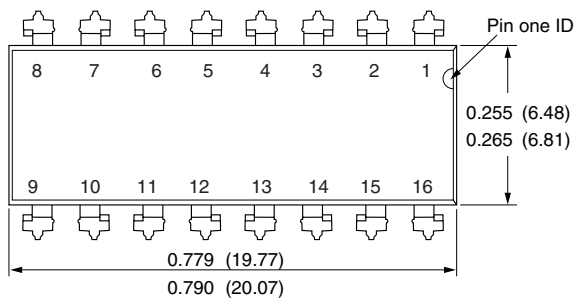

i178007





# ILD1/ILD2/ILD5/ILQ1/ILQ2/ILQ5

Optocoupler, Phototransistor Output  
(Dual, Quad Channel)

Vishay Semiconductors

**Option 6**

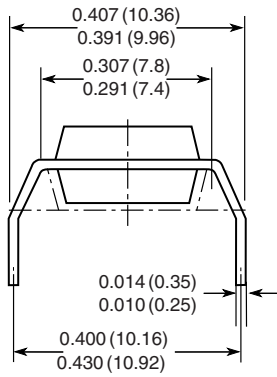

**Option 7**

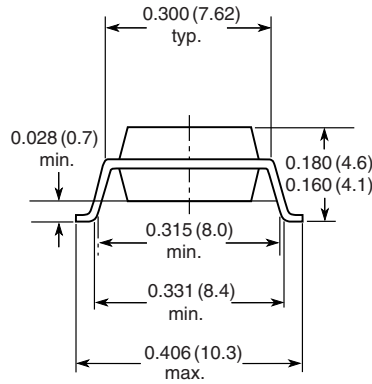

**Option 9**

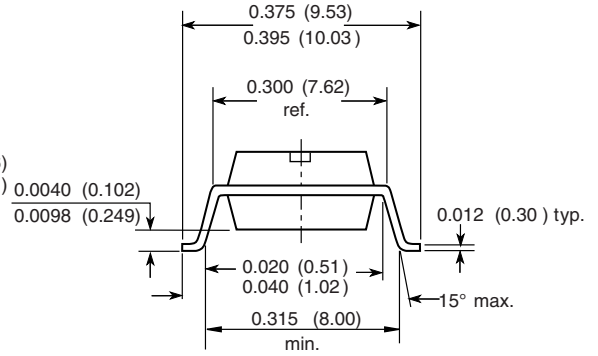

18450

## **OZONE DEPLETING SUBSTANCES POLICY STATEMENT**

It is the policy of Vishay Semiconductor GmbH to

1. Meet all present and future national and international statutory requirements.
2. Regularly and continuously improve the performance of our products, processes, distribution and operating systems with respect to their impact on the health and safety of our employees and the public, as well as their impact on the environment.

It is particular concern to control or eliminate releases of those substances into the atmosphere which are known as ozone depleting substances (ODSs).

The Montreal Protocol (1987) and its London Amendments (1990) intend to severely restrict the use of ODSs and forbid their use within the next ten years. Various national and international initiatives are pressing for an earlier ban on these substances.

Vishay Semiconductor GmbH has been able to use its policy of continuous improvements to eliminate the use of ODSs listed in the following documents.

1. Annex A, B and list of transitional substances of the Montreal Protocol and the London Amendments respectively.
2. Class I and II ozone depleting substances in the Clean Air Act Amendments of 1990 by the Environmental Protection Agency (EPA) in the USA.
3. Council Decision 88/540/EEC and 91/690/EEC Annex A, B and C (transitional substances) respectively.

Vishay Semiconductor GmbH can certify that our semiconductors are not manufactured with ozone depleting substances and do not contain such substances.

We reserve the right to make changes to improve technical design  
and may do so without further notice.

Parameters can vary in different applications. All operating parameters must be validated for each customer application by the customer. Should the buyer use Vishay Semiconductors products for any unintended or unauthorized application, the buyer shall indemnify Vishay Semiconductors against all claims, costs, damages, and expenses, arising out of, directly or indirectly, any claim of personal damage, injury or death associated with such unintended or unauthorized use.

Vishay Semiconductor GmbH, P.O.B. 3535, D-74025 Heilbronn, Germany



## Disclaimer

All product specifications and data are subject to change without notice.

Vishay Intertechnology, Inc., its affiliates, agents, and employees, and all persons acting on its or their behalf (collectively, "Vishay"), disclaim any and all liability for any errors, inaccuracies or incompleteness contained herein or in any other disclosure relating to any product.

Vishay disclaims any and all liability arising out of the use or application of any product described herein or of any information provided herein to the maximum extent permitted by law. The product specifications do not expand or otherwise modify Vishay's terms and conditions of purchase, including but not limited to the warranty expressed therein, which apply to these products.

No license, express or implied, by estoppel or otherwise, to any intellectual property rights is granted by this document or by any conduct of Vishay.

The products shown herein are not designed for use in medical, life-saving, or life-sustaining applications unless otherwise expressly indicated. Customers using or selling Vishay products not expressly indicated for use in such applications do so entirely at their own risk and agree to fully indemnify Vishay for any damages arising or resulting from such use or sale. Please contact authorized Vishay personnel to obtain written terms and conditions regarding products designed for such applications.

Product names and markings noted herein may be trademarks of their respective owners.