

**48Vin  
Input**

**1.2Vout  
Output**

**15Amp  
Current**

**2000Vdc  
Isolation**

**Eighth-brick  
DC/DC Converter**

The PQ60012EML15 PowerQor® Mega eighth-brick converter is a next-generation, board-mountable, isolated, fixed switching frequency DC/DC converter that uses synchronous rectification to achieve extremely high conversion efficiency. The power dissipated by the converter is so low that a heatsink is not required, which saves cost, weight, height, and application effort. All of the power and control components are mounted to the multi-layer PCB substrate with high-yield surface mount technology. Since the PowerQor converter has no explicit thermal interfaces, it is extremely reliable. RoHS compliant (see page 12).

**PowerQor®  
Mega**

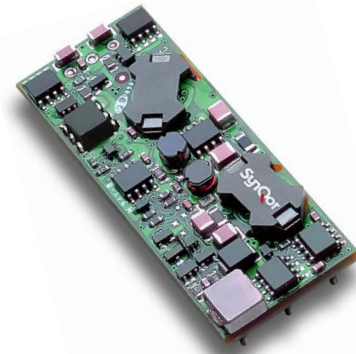

PQ60012EML15 Module

#### Operational Features

- High efficiency, >84% at full rated load current
- Delivers up to 15 amps of output current with minimal derating - no heatsink required
- Wide input voltage range: 35V – 75V, with 100V 100ms input voltage transient capability
- Fixed frequency switching provides predictable EMI performance
- No minimum load requirement means no preload resistors required

#### Mechanical Features

- Industry standard eighth-brick pin-out configuration
- Industry standard size: 0.90" x 2.3" (22.9x58.4mm)
- Total height only 0.335" (8.5mm), permits better airflow and smaller card pitch
- Total weight: 0.68 oz. (19 grams)
- Flanged pins designed to permit surface mount soldering (avoid wave solder) using FPiP technique

#### Control Features

- On/Off control referenced to input side (positive and negative logic options are available)
- Remote sense for the output voltage compensates for output distribution drops
- Output voltage trim permits custom voltages and voltage margining

#### Protection Features

- Input under-voltage lockout disables converter at low input voltage conditions
- Output current limit and short circuit protection protects converter and load from permanent damage and consequent hazardous conditions
- Active back bias limit prevents damage to converter from external load induced pre-bias
- Output over-voltage protection protects load from damaging voltages
- Thermal shutdown protects converter from abnormal environmental conditions

#### Safety Features

- 2000V, 30 MΩ input-to-output isolation provides input/output ground separation
- UL 60950-1 recognized (US & Canada), basic insulation rating
- TUV certified to EN60950-1
- Meets 72/23/EEC and 93/68/EEC directives which facilitates CE Marking in user's end product
- Board and plastic components meet UL94V-0 flammability requirements

**Input:** 35-75 V  
**Output:** 1.2 V  
**Current:** 15 A (18W)  
**Package:** Eighth-brick

### MECHANICAL DIAGRAM

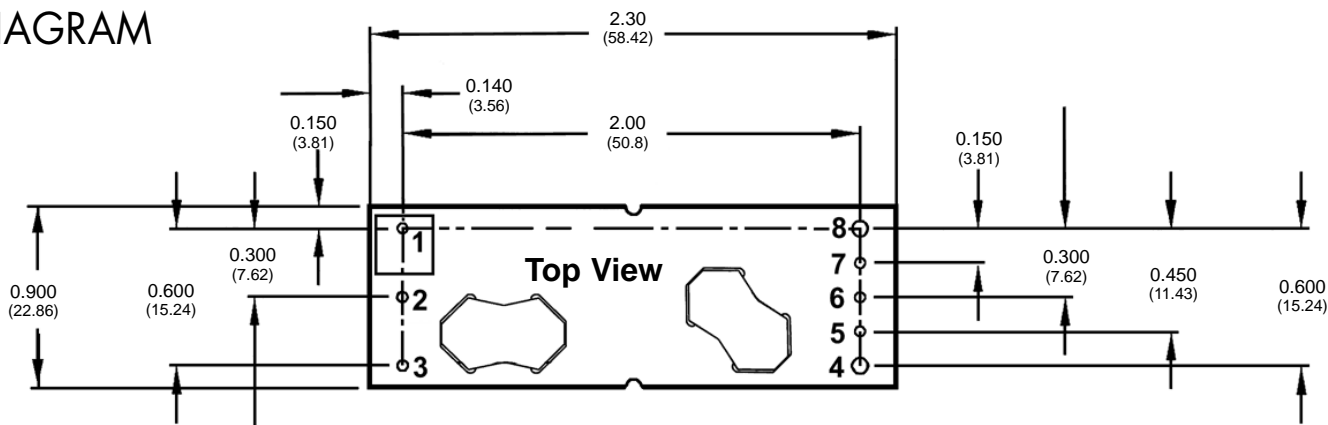

### Side View

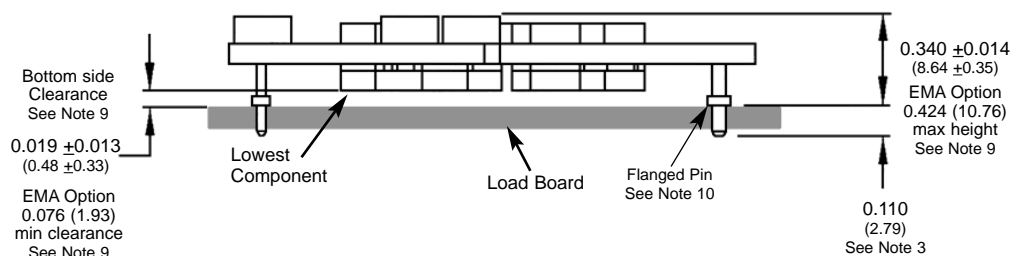

### NOTES

- 1) Pins 1-3, 5-7 are 0.040" (1.02mm) diameter. with 0.080" (2.03mm) diameter standoff shoulders.
- 2) Pins 4 and 8 are 0.062" (1.57 mm) diameter with 0.100" (2.54 mm) diameter standoff shoulders.
- 3) Other pin extension lengths available. Recommended pin length is 0.03" (0.76mm) greater than the PCB thickness.
- 4) All Pins: Material - Copper Alloy  
Finish - Tin/Lead over Nickel plate
- 5) Undimensioned components are shown for visual reference only.
- 6) All dimensions in inches (mm)  
Tolerances: x.xx +/-0.02 in. (x.x +/-0.5mm)  
x.xxx +/-0.010 in. (x.xx +/-0.25mm)
- 7) Weight: 0.68 oz. (19 g) typical
- 8) Workmanship: Meets or exceeds IPC-A-610C Class II
- 9) Modules ordered as an EGA option have different pins to provide a minimum bottom side clearance of 0.076" while increasing maximum height to 0.424". See ordering page for more information.
- 10) The flanged pins are designed to permit surface mount soldering (allowing to avoid the wave soldering process) through the use of the flanged pin-in-paste technique.

### PIN DESIGNATIONS

| Pin No. | Name     | Function   |
|---------|----------|--|
| 1       | Vin(+)   | Positive input voltage   |
| 2       | ON/OFF   | TTL input to turn converter on and off, referenced to Vin(-), with internal pull up. |
| 3       | Vin(-)   | Negative input voltage   |
| 4       | Vout(-)  | Negative output voltage  |
| 5       | SENSE(-) | Negative remote sense <sup>1</sup>   |
| 6       | TRIM     | Output voltage trim <sup>2</sup>   |
| 7       | SENSE(+) | Positive remote sense <sup>3</sup>   |
| 8       | Vout(+)  | Positive output voltage  |

#### Notes:

1. SENSE(-) should be connected to Vout(-) either remotely or at the converter.
2. Leave TRIM pin open for nominal output voltage.
3. SENSE(+) should be connected to Vout(+) either remotely or at the converter.

## PQ60012EML15 ELECTRICAL CHARACTERISTICS

T<sub>A</sub>=25°C, airflow rate=300 LFM, V<sub>in</sub>=48Vdc unless otherwise noted; full operating temperature range is -40°C to +100°C ambient temperature with appropriate power derating. Specifications subject to change without notice.

| Parameter   | Min.  | Typ.      | Max.      | Units            | Notes & Conditions                          |
|---|-------|-----------|-----------|------------------|---|
| <b>ABSOLUTE MAXIMUM RATINGS</b>                     |       |           |           |                  |   |
| Input Voltage                                       |       |           |           |                  |   |
| Non-Operating                                       |       |           | 100       | V                | Continuous                                  |
| Operating   |       |           | 80        | V                | Continuous                                  |
| Operating Transient Protection                      |       |           | 100       | V                | 100ms transient, square wave                |
| Isolation Voltage (input to output)                 |       |           | 2000      | V                | Basic insulation, Pollution Degree 2        |
| Operating Temperature                               | -40   |           | 100       | °C               |   |
| Storage Temperature                                 | -55   |           | 125       | °C               |   |
| Voltage at ON/OFF input pin                         | -2    |           | 18        | V                |   |
| <b>INPUT CHARACTERISTICS</b>                        |       |           |           |                  |   |
| Operating Input Voltage Range                       | 35    | 48        | 75        | V                |   |
| Input Under-Voltage Lockout                         |       |           |           |                  |   |
| Turn-On Voltage Threshold                           | 31.5  | 33.3      | 34.4      | V                |   |
| Turn-Off Voltage Threshold                          | 29.5  | 31.0      | 32.4      | V                |   |
| Lockout Voltage Hysteresis                          | 2.2   | 2.3       | 2.4       | V                |   |
| Maximum Input Current                               |       |           | 0.7       | A                | 100% Load, 35 Vin                           |
| No-Load Input Current                               |       | 25        |           | mA               |   |
| Disabled Input Current                              |       | 2         | 5         | mA               |   |
| Inrush Current Transient Rating                     |       | 0.01      |           | A <sup>2</sup> s |   |
| Response to Input Transient                         |       | 50        |           | mV               | 1000V/ms input transient                    |
| Input Reflected Ripple Current                      |       | 3         |           | mA               | RMS thru 10µH inductor; Figures 13 & 15     |
| Input Terminal Ripple Current                       |       | 95        |           | mA               | RMS; Figures 13 & 14                        |
| Recommended Input Fuse                              |       |           | 10        | A                | Fast blow external fuse recommended         |
| Input Filter Component Values (CVL)                 |       | 1.0\4.7   |           | µF\µH            | Internal values; Figure E                   |
| Recommended External Input Capacitance              |       | 47        |           | µF               | Typical ESR 0.1-0.2Ω; Figure 13             |
| <b>OUTPUT CHARACTERISTICS</b>                       |       |           |           |                  |   |
| Output Voltage Set Point                            | 1.188 | 1.20      | 1.212     | V                |   |
| Output Voltage Regulation                           |       |           |           |                  |   |
| Over Line   |       | ±0.08 \ 1 | ±0.25 \ 3 | %\mV             |   |
| Over Load   |       | ±0.08 \ 1 | ±0.25 \ 3 | %\mV             |   |
| Over Temperature                                    |       | ±6        | ±20       | mV               |   |
| Total Output Voltage Range                          | 1.155 |           | 1.245     | V                | Over sample, line, load, temperature & life |
| Output Voltage Ripple and Noise <sup>1</sup>        |       |           |           |                  | 20MHz bandwidth; Figures 13 & 16            |
| Peak-to-Peak  |       | 60        | 110       | mV               | Full Load; Figures 13 & 16                  |
| RMS   |       | 15        | 25        | mV               | Full Load; Figures 13 & 16                  |
| Operating Output Current Range                      | 0     |           | 15        | A                | Subject to thermal derating; Figures 5 - 8  |
| Output DC Current Limit Inception                   | 16    | 17        | 20.6      | A                | Output Voltage 10% Low; Figure 17           |
| Output DC Current Limit Shutdown Voltage            |       | 0.65      |           | V                |   |
| Back-Drive Current Limit while Enabled              | 0.3   | 0.6       | 0.95      | A                | Negative current drawn from output          |
| Back-Drive Current Limit while Disabled             | 50    | 75        | 135       | mA               | Negative current drawn from output          |
| Maximum Output Capacitance                          |       |           | 45,000    | µF               | 1.2Vout at 15A Resistive Load               |
| <b>DYNAMIC CHARACTERISTICS</b>                      |       |           |           |                  |   |
| Input Voltage Ripple Rejection                      |       | 80        |           | dB               | 120 Hz; Figure 20                           |
| Output Voltage during Load Current Transient        |       |           |           |                  |   |
| For a Step Change in Output Current (0.1A/µs)       |       | 35        |           | mV               | 50% to 75% to 50% lout max; Figure 11       |
| For a Step Change in Output Current (5A/µs)         |       | 65        |           | mV               | 50% to 75% to 50% lout max; Figure 12       |
| Settling Time                                       |       | 600       |           | µs               | To within 1% Vout nom                       |
| Turn-On Transient                                   |       |           |           |                  |   |
| Turn-On Time  |       | 3         | 8         | ms               | Full load, Vout=90% nom.; Figures 9 & 10    |
| Start-Up Inhibit Time                               | 180   | 200       | 240       | ms               | -40°C to +125°C; Figure F                   |
| Output Voltage Overshoot                            |       | 0         |           | %                | 45,000 µF load capacitance, lout = 0A       |
| <b>EFFICIENCY</b>                                   |       |           |           |                  |   |
| 100% Load   |       | 84.5      |           | %                | Figures 1 - 4                               |
| 50% Load  |       | 85        |           | %                | Figures 1 - 4                               |
| <b>TEMPERATURE LIMITS FOR POWER DERATING CURVES</b> |       |           |           |                  |   |
| Semiconductor Junction Temperature                  |       |           | 125       | °C               | Package rated to 150°C                      |
| Board Temperature                                   |       |           | 125       | °C               | UL rated max operating temp 130°C           |
| Transformer Temperature                             |       |           | 125       | °C               | See Figures 5 - 8 for derating curves       |
| <b>ISOLATION CHARACTERISTICS</b>                    |       |           |           |                  |   |
| Isolation Voltage (dielectric strength)             |       | 2000      |           | V                |   |
| Isolation Resistance                                |       | 30        |           | MΩ               |   |
| Isolation Capacitance <sup>2</sup>                  |       | 470       |           | pF               |   |

Note 1: For applications requiring reduced output voltage ripple and noise, consult SynQor applications support (e-mail: [support@synqor.com](mailto:support@synqor.com))

Note 2: Higher values of isolation capacitance can be added external to the module.



# Technical Specification

**Input:** 35-75 V  
**Output:** 1.2 V  
**Current:** 15 A (18W)  
**Package:** Eighth-brick

## ELECTRICAL CHARACTERISTICS (Continued)

| Parameter                                    | Min. | Typ.               | Max. | Units                | Notes & Conditions                                   |
|--|------|--------------------|------|----------------------|--|
| <b>FEATURE CHARACTERISTICS</b>               |      |                    |      |                      |  |
| Switching Frequency                          | 195  | 225                | 255  | kHz                  | Buck stage and isolation stage                       |
| ON/OFF Control (Option P)                    |      |                    |      |                      |  |
| Off-State Voltage                            | -2   |                    | 0.8  | V                    |  |
| On-State Voltage                             | 2.4  |                    | 18   | V                    |  |
| ON/OFF Control (Option N)                    |      |                    |      |                      |  |
| Off-State Voltage                            | 2.4  |                    | 18   | V                    |  |
| On-State Voltage                             | -2   |                    | 0.8  | V                    |  |
| ON/OFF Control (Either Option)               |      |                    |      |                      | Figures A & B  |
| Pull-Up Voltage                              |      | V <sub>in</sub> /6 | 15   | V                    |  |
| Pull-Up Resistance                           |      | 40                 |      | kΩ                   |  |
| Output Voltage Trim Range                    | -20  |                    | +10  | %                    | Measured across Pins 8 & 4; Figure C                 |
| Output Voltage Remote Sense Range            |      |                    | +10  | %                    | Measured across Pins 8 & 4                           |
| Output Over-Voltage Protection               | 120  | 125                | 130  | %                    | Over full temp range; % of nominal V <sub>out</sub>  |
| Over-Temperature Shutdown                    |      | 125                |      | °C                   | Average PCB Temperature                              |
| Over-Temperature Shutdown Restart Hysteresis |      | 10                 |      | °C                   |  |
| Load Current Scale Factor                    |      | 500                |      |                      | See web app. note Output Load Current Calc.          |
| <b>RELIABILITY CHARACTERISTICS</b>           |      |                    |      |                      |  |
| Calculated MTBF (Telcordia)                  |      | 2.4                |      | 10 <sup>6</sup> Hrs. | TR-NWT-000332; 80% load, 300LFM, 40°C T <sub>a</sub> |
| Calculated MTBF (MIL-217)                    |      | 1.4                |      | 10 <sup>6</sup> Hrs. | MIL-HDBK-217F; 80% load, 300LFM, 40°C T <sub>a</sub> |
| Field Demonstrated MTBF                      |      |                    |      | 10 <sup>6</sup> Hrs. | See our <a href="#">website</a> for details          |

## STANDARDS COMPLIANCE

| Parameter                       | Notes   |
|---------------------------------|---|
| <b>STANDARDS COMPLIANCE</b>     |   |
| UL/cUL 60950                    | File # E194341, Basic insulation & pollution degree 2                 |
| EN60950                         | Certified by TÜV  |
| 72/23/EEC                       |   |
| 93/68/EEC                       |   |
| Needle Flame Test (IEC 695-2-2) | test on entire assembly; board & plastic components UL94V-0 compliant |
| IEC 61000-4-2                   | ESD test, 8kV - NP, 15kV air - NP (Normal Performance)                |
| GR-1089-CORE                    | Section 7 - electrical safety, Section 9 - bonding/grounding          |
| Telcordia (Bellcore) GR-513     |   |

- An external input fuse must always be used to meet these safety requirements. Contact SynQor for official safety certificates on new releases or download from the [SynQor website](#).

## QUALIFICATION TESTING

| Parameter                    | # Units | Test Conditions  |
|------------------------------|---------|--|
| <b>QUALIFICATION TESTING</b> |         |  |
| Life Test                    | 32      | 95% rated V <sub>in</sub> and load, units at derating point, 1000 hours                                |
| Vibration                    | 5       | 10-55Hz sweep, 0.060" total excursion, 1 min./sweep, 120 sweeps for 3 axis                             |
| Mechanical Shock             | 5       | 100g minimum, 2 drops in x and y axis, 1 drop in z axis  |
| Temperature Cycling          | 10      | -40°C to 100°C, unit temp. ramp 15°C/min., 500 cycles  |
| Power/Thermal Cycling        | 5       | Toperating = min to max, V <sub>in</sub> = min to max, full load, 100 cycles                           |
| Design Marginality           | 5       | T <sub>min</sub> -10°C to T <sub>max</sub> +10°C, 5°C steps, V <sub>in</sub> = min to max, 0-105% load |
| Humidity                     | 5       | 85°C, 85% RH, 1000 hours, 2 minutes on and 6 hours off   |
| Solderability                | 15 pins | MIL-STD-883, method 2003   |

- Extensive characterization testing of all SynQor products and manufacturing processes is performed to ensure that we supply robust, reliable product. Contact the factory for official product family qualification documents.

## OPTIONS

SynQor provides various options for Packaging, Enable Logic, and Feature Set for this family of DC/DC converters. Please consult the [last page](#) for information on available options.

## PATENTS

SynQor is protected under various patents. Please consult the [last page](#) for further details.

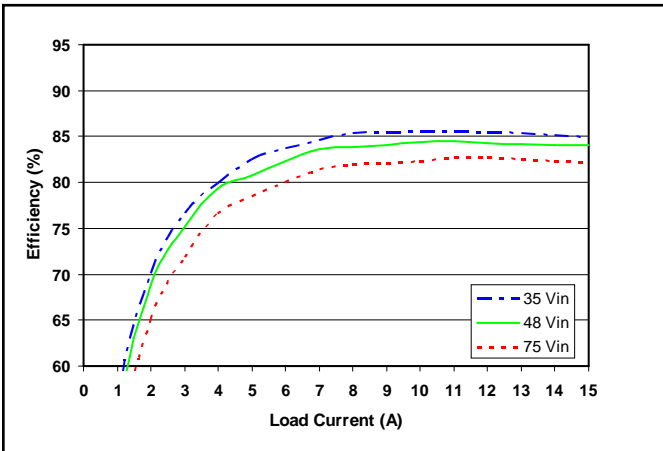

Figure 1: Efficiency at nominal output voltage vs. load current for minimum, nominal, and maximum input voltage at 25°C.

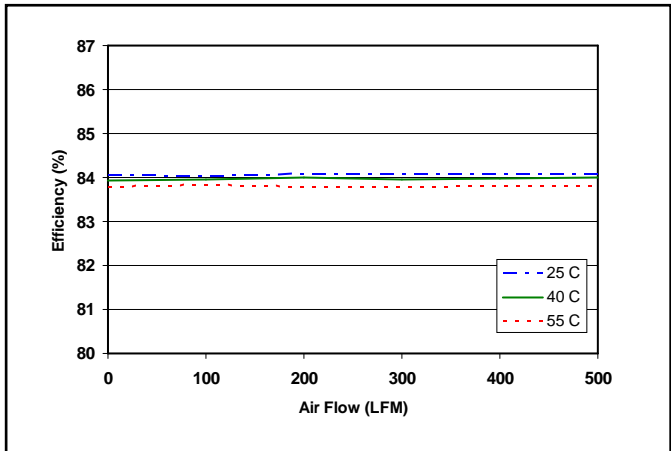

Figure 2: Efficiency at nominal output voltage and 60% rated power vs. airflow rate for ambient air temperatures of 25°C, 40°C, and 55°C (nominal input voltage).

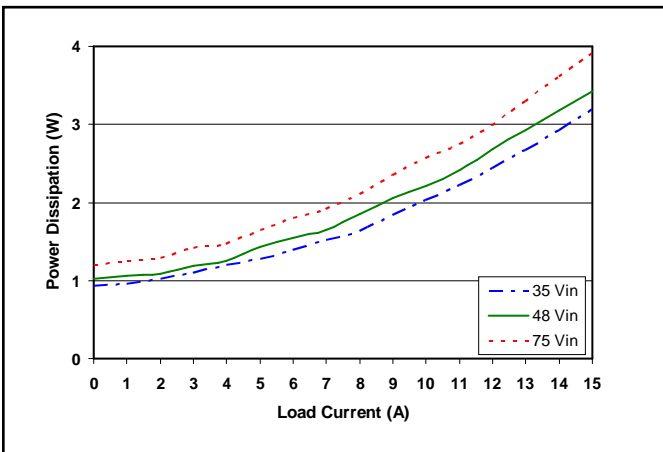

Figure 3: Power dissipation at nominal output voltage vs. load current for minimum, nominal, and maximum input voltage at 25°C.

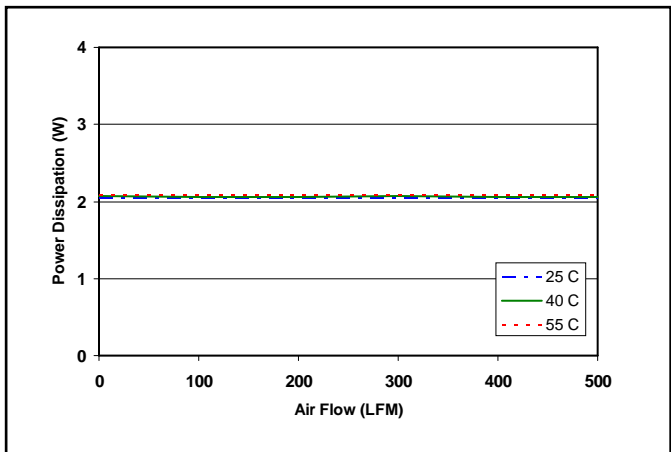

Figure 4: Power dissipation at nominal output voltage and 60% rated power vs. airflow rate for ambient air temperatures of 25°C, 40°C, and 55°C (nominal input voltage).

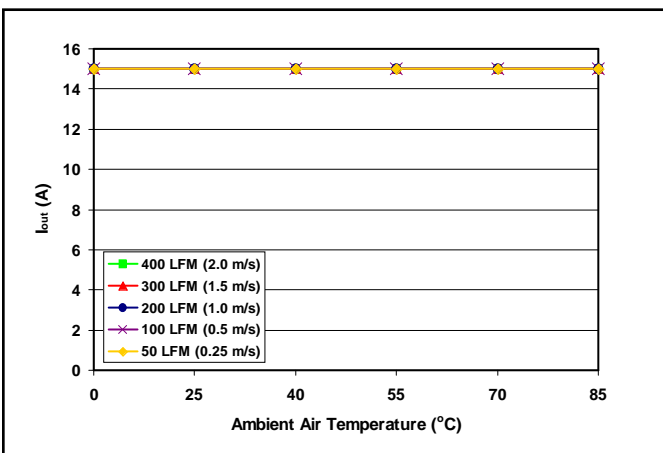

Figure 5: Maximum output power derating curves vs. ambient air temperature for airflow rates of 50 LFM through 400 LFM with air flowing across the converter from pin 3 to pin 1 (nominal input voltage).

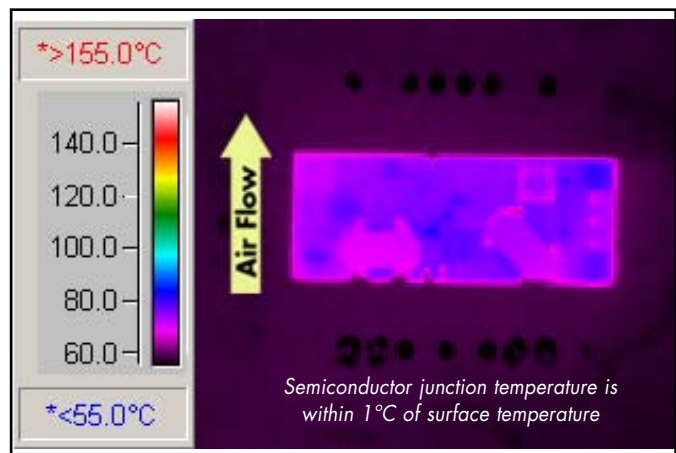
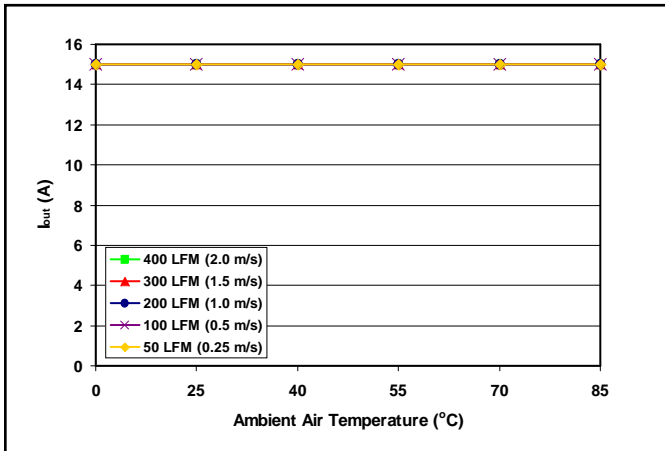
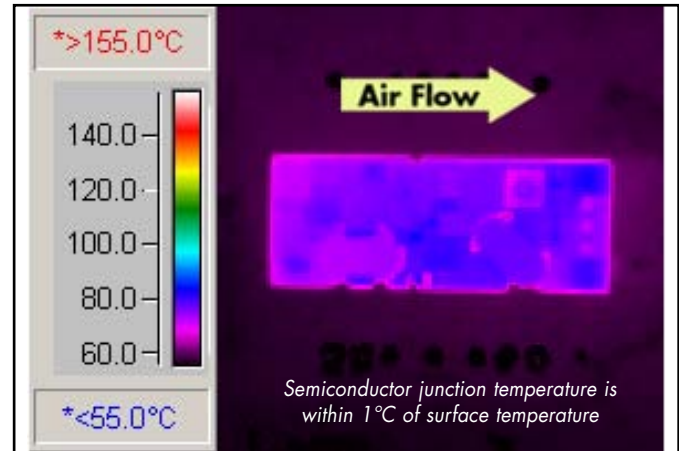

Figure 6: Thermal plot of converter at 15 amp load current with 55°C air flowing at the rate of 200 LFM. Air is flowing across the converter sideways from pin 3 to pin 1 (nominal input voltage).



**Figure 7:** Maximum output power-de-rating curves vs. ambient air temperature for airflow rates of 50 LFM through 400 LFM with air flowing from input to output (nominal input voltage).



**Figure 8:** Thermal plot of converter at 15 amp load current with 55 $^{\circ}$ C air flowing at the rate of 200 LFM. Air is flowing across the converter from input to output (nominal input voltage).

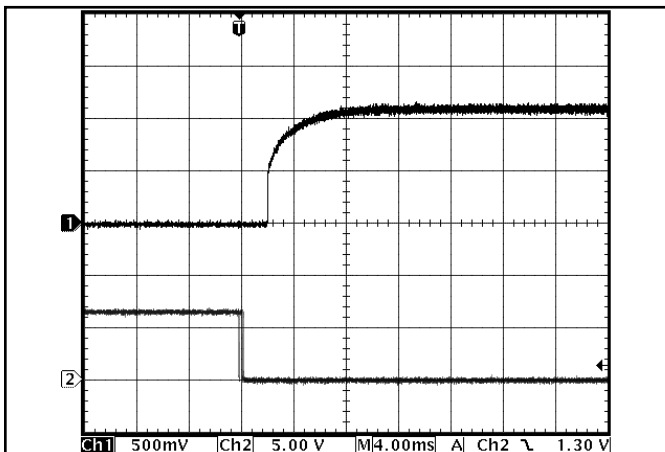

**Figure 9:** Turn-on transient at full load (resistive load) (4 ms/div). Input voltage pre-applied. Ch 1:  $V_{out}$  (500mV/div). Ch 2: ON/OFF input (5V/div)

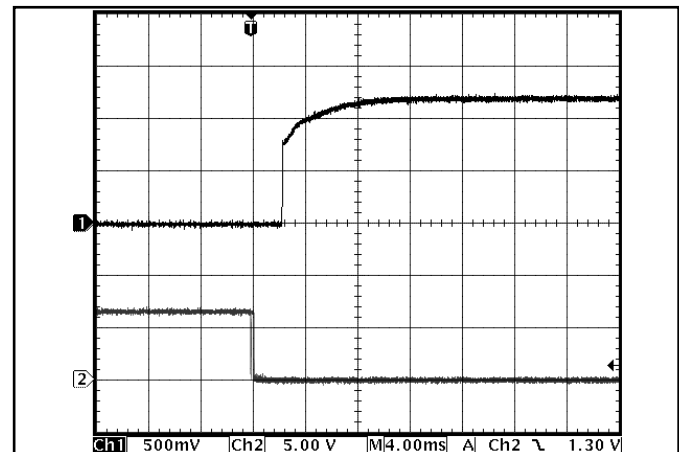

**Figure 10:** Turn-on transient at zero load (4 ms/div). Ch 1:  $V_{out}$  (500mV/div) Ch 2: ON/OFF input (5V/div)

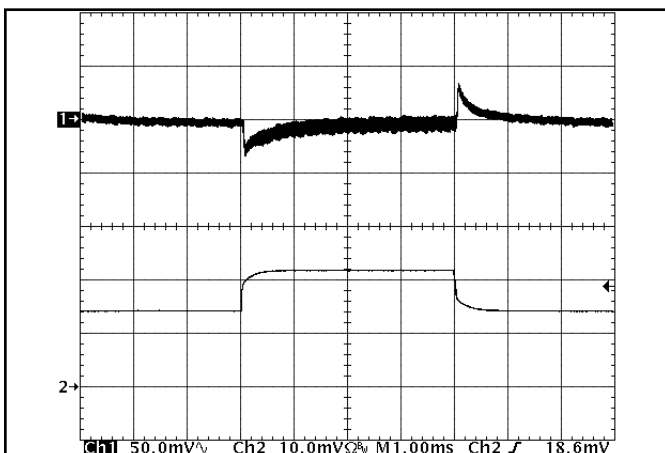

**Figure 11:** Output voltage response to step-change in load current (50%-75%-50% of  $I_{out(max)}$ ;  $dI/dt = 0.1A/\mu s$ ). Load cap: 10 $\mu$ F, 100 m $\Omega$  ESR tantalum capacitor and 1 $\mu$ F ceramic capacitor. Ch 1:  $V_{out}$  (50mV/div), Ch 2:  $I_{out}$  (5A/div).

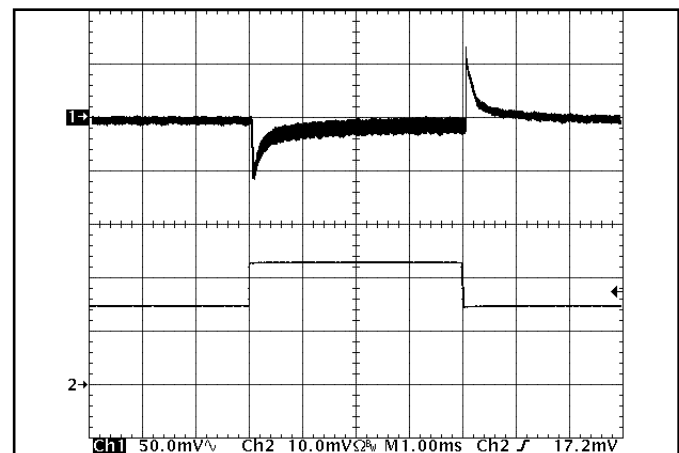

**Figure 12:** Output voltage response to step-change in load current (50%-75%-50% of  $I_{out(max)}$ ;  $dI/dt = 5A/\mu s$ ). Load cap: 470 $\mu$ F, 30 m $\Omega$  ESR tantalum capacitor and 1 $\mu$ F ceramic cap. Ch 1:  $V_{out}$  (50mV/div), Ch 2:  $I_{out}$  (5A/div).

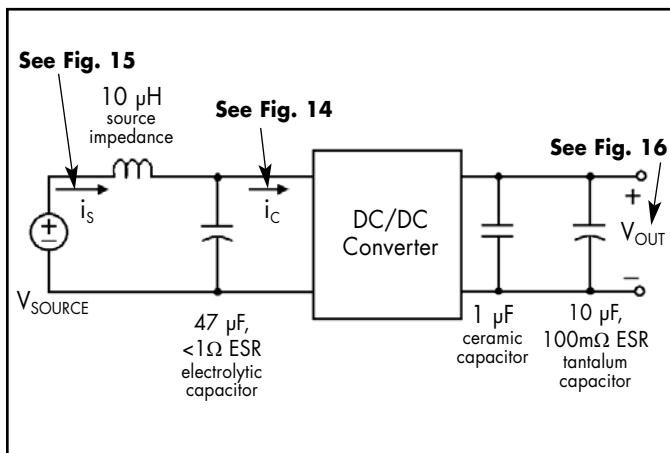

**Figure 13:** Test set-up diagram showing measurement points for Input Terminal Ripple Current (Figure 14), Input Reflected Ripple Current (Figure 15) and Output Voltage Ripple (Figure 16).

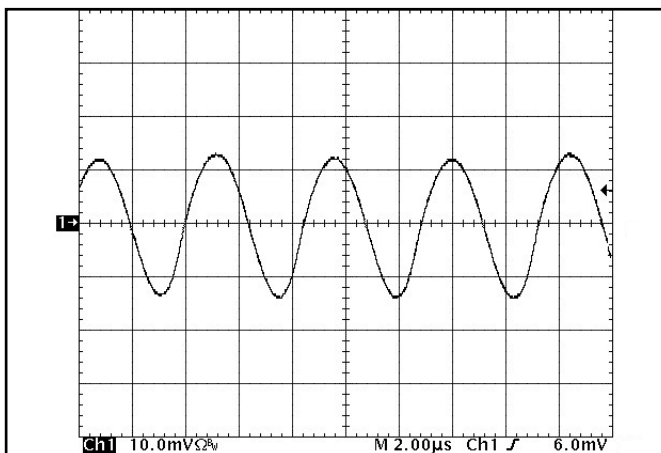

**Figure 14:** Input Terminal Ripple Current,  $i_c$ , at full rated output current and nominal input voltage with  $10\ \mu\text{H}$  source impedance and  $47\ \mu\text{F}$  electrolytic capacitor ( $100\ \text{mA}/\text{div}$ ). See Figure 13.

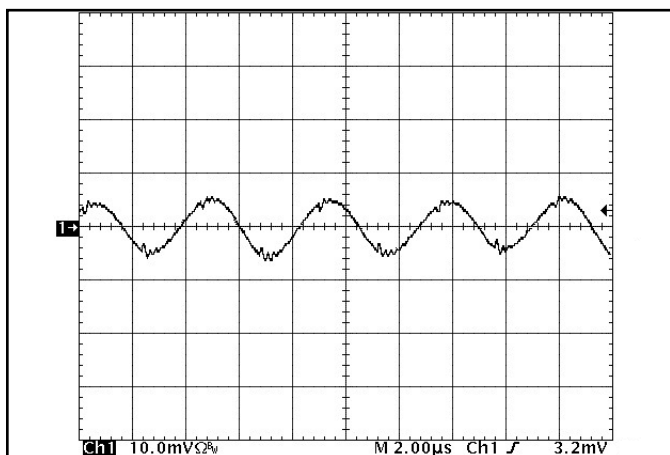

**Figure 15:** Input Reflected Ripple Current,  $i_s$ , through a  $10\ \mu\text{H}$  source inductor at nominal input voltage and rated load current ( $5\ \text{mA}/\text{div}$ ). See Figure 13.

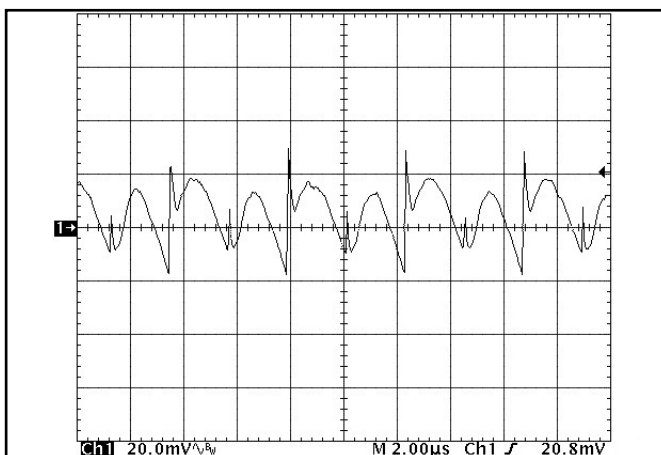

**Figure 16:** Output Voltage Ripple at nominal input voltage and rated load current ( $20\ \text{mV}/\text{div}$ ). Load capacitance:  $1\ \mu\text{F}$  ceramic capacitor and  $10\ \mu\text{F}$  tantalum capacitor. Bandwidth:  $20\ \text{MHz}$ . See Figure 13.

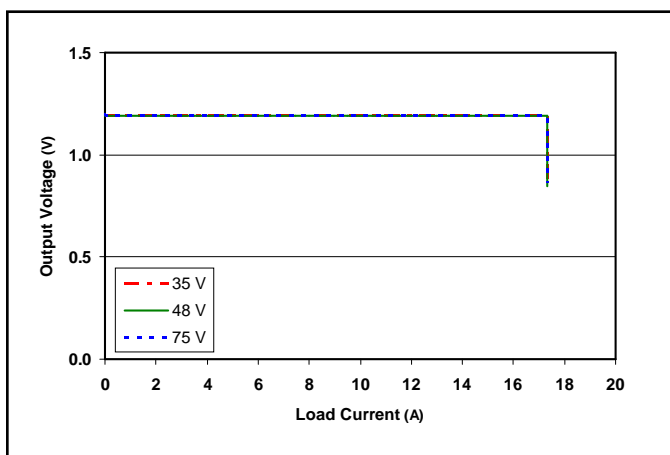

**Figure 17:** Output voltage vs. load current showing typical current limit curves and converter shutdown points.

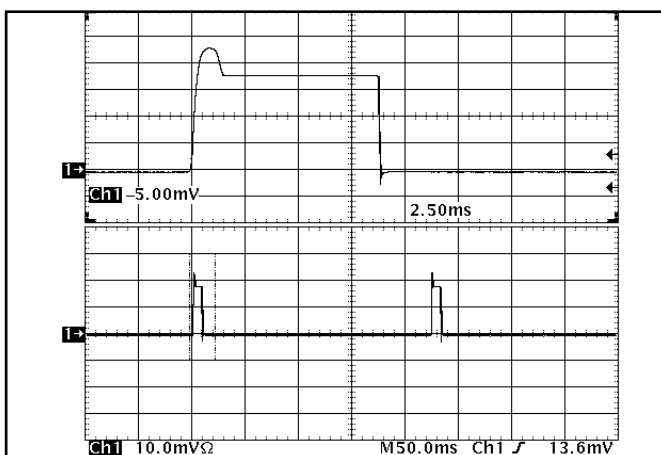

**Figure 18:** Load current ( $10\ \text{A}/\text{div}$ ) as a function of time when the converter attempts to turn on into a  $10\ \text{m}\Omega$  short circuit. Top trace ( $2.5\ \text{ms}/\text{div}$ ) is an expansion of the on-time portion of the bottom trace.

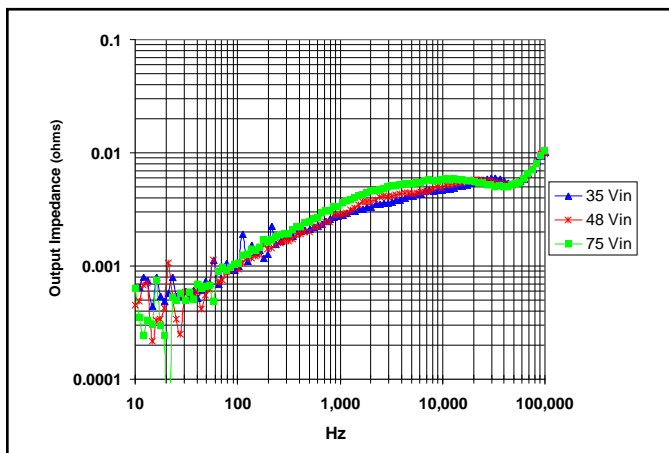

**Figure 19:** Magnitude of incremental output impedance ( $Z_{out} = v_{out}/i_{out}$ ) for minimum, nominal, and maximum input voltage at full rated power.

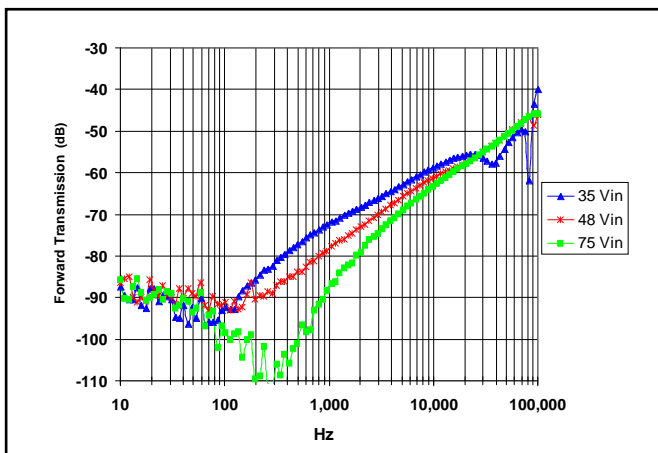

**Figure 20:** Magnitude of incremental forward transmission ( $FT = v_{out}/v_{in}$ ) for minimum, nominal, and maximum input voltage at full rated power.

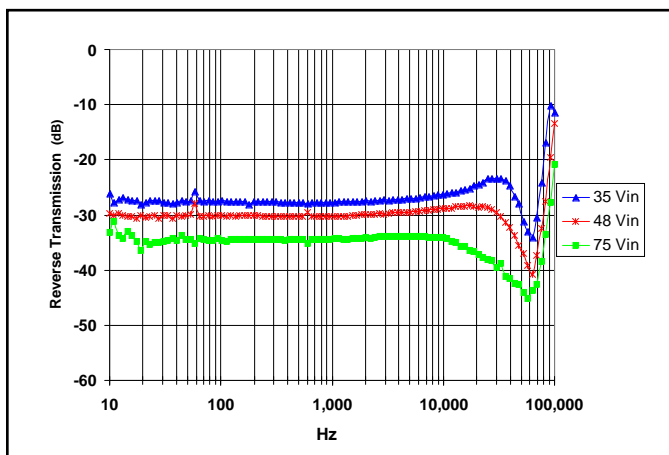

**Figure 21:** Magnitude of incremental reverse transmission ( $RT = i_{in}/i_{out}$ ) for minimum, nominal, and maximum input voltage at full rated power.

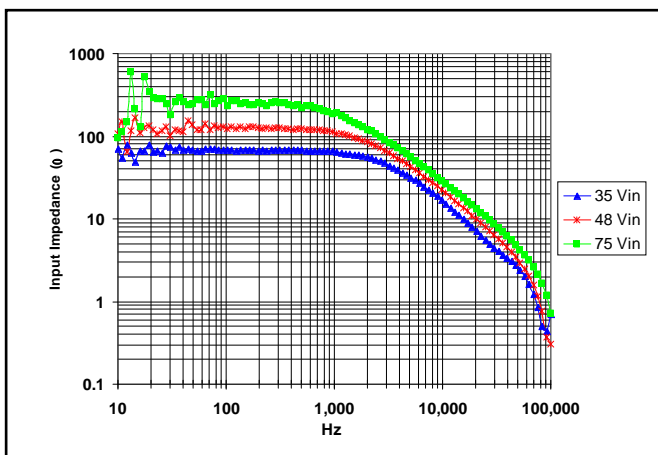

**Figure 22:** Magnitude of incremental input impedance ( $Z_{in} = v_{in}/i_{in}$ ) for minimum, nominal, and maximum input voltage at full rated power.

### BASIC OPERATION AND FEATURES

The PowerQor series converter uses a two-stage power conversion topology. The first stage is a buck-converter that keeps the output voltage constant over variations in line, load, and temperature. The second stage uses a transformer to provide the functions of input/output isolation and voltage step-down to achieve the low output voltage required.

Both the first stage and the second stage switch at a fixed frequency for predictable EMI performance. Rectification of the transformer's output is accomplished with synchronous rectifiers. These devices, which are MOSFETs with a very low on-state resistance, dissipate far less energy than Schottky diodes. This is the primary reason that the PowerQor converter has such high efficiency, even at very low output voltages and very high output currents.

Dissipation throughout the converter is so low that it does not require a heatsink for operation. Since a heatsink is not required, the PowerQor converter does not need a metal baseplate or potting material to help conduct the dissipated energy to the heatsink. The PowerQor converter can thus be built more simply and reliably using high yield surface mount techniques on a PCB substrate.

The PowerQor series of eighth-brick, quarter-brick and half-brick converters uses the industry standard footprint and pin-out configuration.

### CONTROL FEATURES

**REMOTE ON/OFF (Pin 2):** The ON/OFF input, Pin 2, permits the user to control when the converter is on or off. This input is referenced to the return terminal of the input bus, Vin(-). There are two versions of the converter that differ by the sense of the logic used for the ON/OFF input.

In the positive logic version, the ON/OFF input is active high (meaning that a high turns the converter on). In the negative logic version, the ON/OFF signal is active low (meaning that a low turns the converter on). Figure A details five possible circuits for driving the ON/OFF pin. Figure B is a detailed look of the internal ON/OFF circuitry.

**REMOTE SENSE(+)** (Pins 7 and 5): The SENSE(±) inputs correct for voltage drops along the conductors that connect the converter's output pins to the load.

Pin 7 should be connected to Vout(+) and Pin 5 should be connected to Vout(-) at the point on the board where regulation is desired. A remote connection at the load can adjust for a voltage drop only as large as that specified in this datasheet, that is

$$[V_{out(+)} - V_{out(-)}] - [V_{sense(+)} - V_{sense(-)}] \leq \text{Sense Range \%} \times V_{out}$$

Pins 7 and 5 must be connected for proper regulation of the output voltage. If these connections are not made, the converter will deliver an output voltage that is slightly higher than its specified value. The converter has 100Ω internal resistors connected between the output and sense pins (see diagram below).

Note: The output over-voltage protection circuit senses the volt-

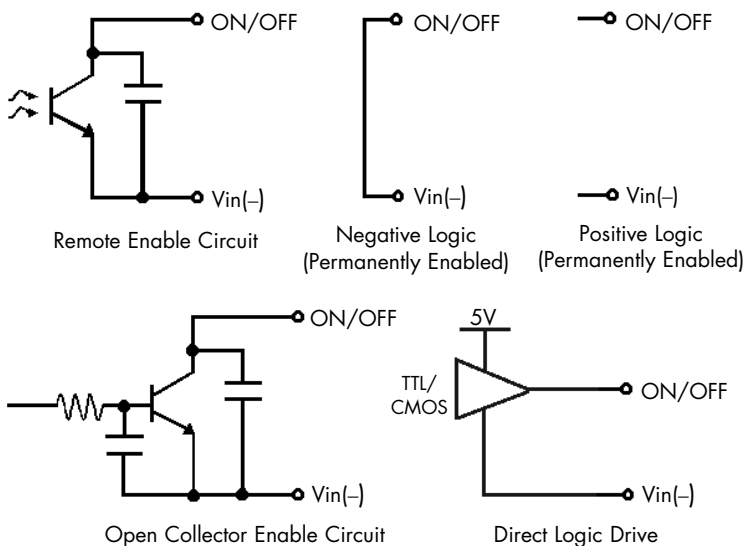

Figure A: Various circuits for driving the ON/OFF pin.

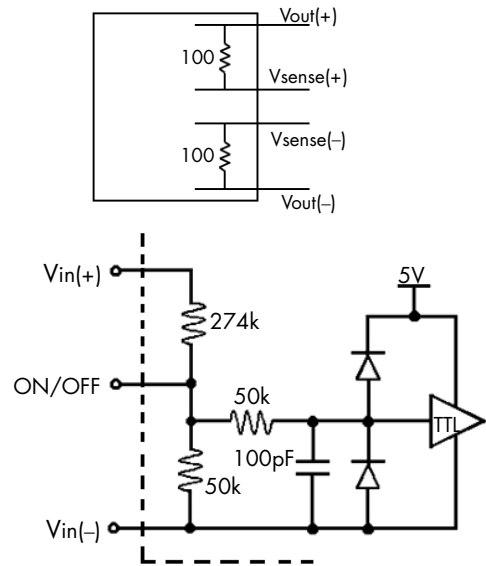

Figure B: Internal ON/OFF pin circuitry

age across the output (pins 8 and 4) to determine when it should trigger, not the voltage across the converter's sense leads (pins 7 and 5). Therefore, the resistive drop on the board should be small enough so that output OVP does not trigger, even during load transients.

**OUTPUT VOLTAGE TRIM (Pin 6):** The TRIM input permits the user to adjust the output voltage across the sense leads up or down according to the trim range specifications.

To decrease the output voltage, the user should connect a resistor between Pin 6 and Pin 5 (SENSE(-) input). To increase the output voltage, the user should connect a resistor between Pin 6 and Pin 7 (SENSE(+) input). For a desired change of the nominal output voltage, the value of the resistor should be

$$R_{\text{trim}} = \left| \frac{V_{\text{DES}}}{V_{\text{NOM}} - V_{\text{DES}}} \right| - 1 \quad (\text{k}\Omega)$$

where

$V_{\text{NOM}}$  = Nominal Voltage

$V_{\text{DES}}$  = Desired Voltage

(Vertical bars indicate absolute value)

Figure C graphs the relationship between the trim resistor value and  $R_{\text{trim-up}}$  and  $R_{\text{trim-down}}$ , showing the total range the output voltage can be trimmed up or down.

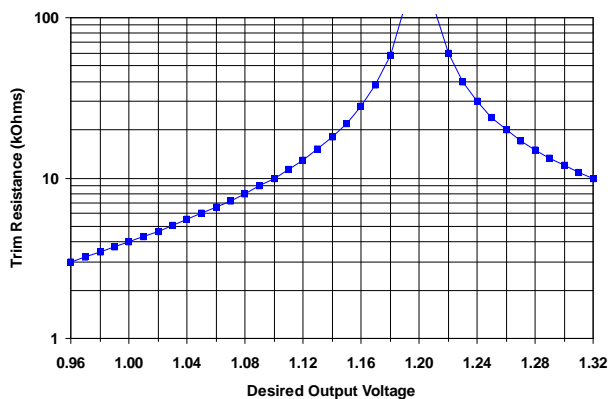

Figure C: Trim Graph for 1.2Vout module

**Note:** the TRIM feature does not affect the voltage at which the output over-voltage protection circuit is triggered. Trimming the output voltage too high may cause the over-voltage protection circuit to engage, particularly during transients.

It is not necessary for the user to add capacitance at the Trim pin. The node is internally bypassed to eliminate noise.

**Total DC Variation of Vout:** For the converter to meet its full specifications, the maximum variation of the DC value of Vout, due to both trimming and remote load voltage drops, should not be greater than that specified for the output voltage trim range.

## PROTECTION FEATURES

**Input Under-Voltage Lockout:** The converter is designed to turn off when the input voltage is too low, helping avoid an input system instability problem, described in more detail in the application note titled "Input System Instability" available on the SynQor website. The lockout circuitry is a comparator with DC hysteresis. When the input voltage is rising, it must exceed the typical Turn-On Voltage Threshold value (listed on the [specification page](#)) before the converter will turn on. Once the converter is on, the input voltage must fall below the typical Turn-Off Voltage Threshold value before the converter will turn off.

**Output Current Limit:** The maximum current limit remains constant as the output voltage drops. However, once the impedance of the short across the output is small enough to make the output voltage drop below the specified Output DC Current-Limit Shutdown Voltage, the converter turns off.

The converter then enters a "hiccup mode" where it repeatedly turns on and off at a 5 Hz (nominal) frequency with a 5% duty cycle until the short circuit condition is removed. This prevents excessive heating of the converter or the load board.

**Output Over-Voltage Limit:** If the voltage across the output pins exceeds the Output Over-Voltage Protection threshold, the converter will immediately stop switching. This prevents damage to the load circuit due to 1) excessive series resistance in output current path from converter output pins to sense point, 2) a release of a short-circuit condition, or 3) a release of a current limit condition. Load capacitance determines exactly how high the output voltage will rise in response to these conditions. After 200 ms the converter will automatically restart.

**Over-Temperature Shutdown:** A temperature sensor on the converter senses the average temperature of the module. The thermal shutdown circuit is designed to turn the converter off when the temperature at the sensed location reaches the Over-Temperature Shutdown value. It will allow the converter to turn on again when the temperature of the sensed location falls by the amount of the Over-Temperature Shutdown Restart Hysteresis value.

### APPLICATION CONSIDERATIONS

**Input System Instability:** This condition can occur because any DC/DC converter appears incrementally as a negative resistance load. A detailed application note titled "Input System Instability" is available on the SynQor website which provides an understanding of why this instability arises, and shows the preferred solution for correcting it.

**Application Circuits:** Figure D provides a typical circuit diagram which details the input filtering and voltage trimming.

**Input Filtering and External Capacitance:** Figure E provides a diagram showing the internal input filter components. This filter dramatically reduces input terminal ripple current, which otherwise could exceed the rating of an external electrolytic input capacitor. The recommended external input capac-

itance is specified in the "Input Characteristics" section. More detailed information is available in the application note titled "EMI Characteristics" on the SynQor website.

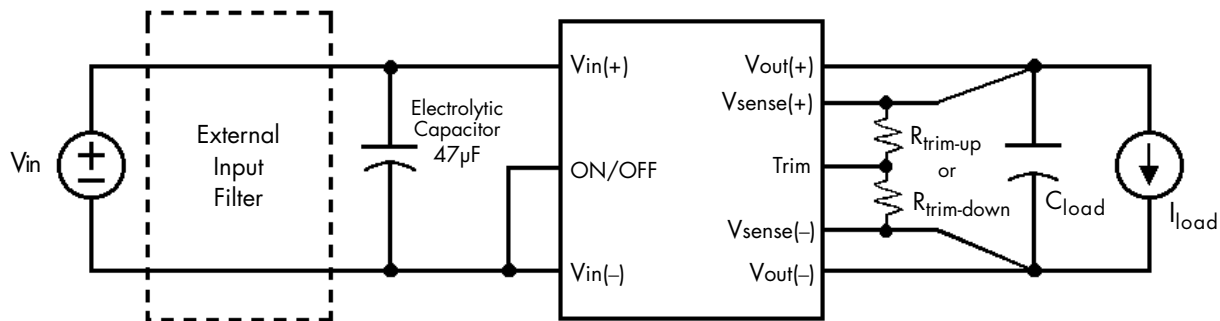

Figure D: Typical application circuit (negative logic unit, permanently enabled).

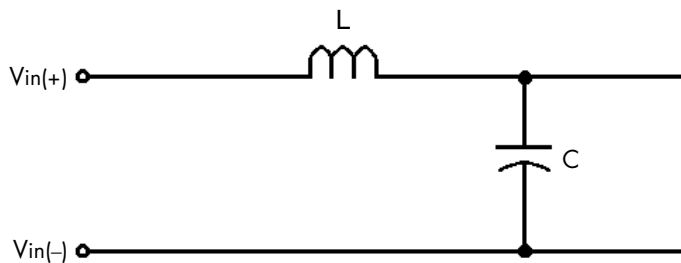

Figure E: Internal Input Filter Diagram (component values listed on the specifications page).

**Startup Inhibit Period:** The Startup Inhibit Period ensures that the converter will remain off for at least 200ms when it is shut down for any reason. When an output short is present, this generates a 5Hz "hiccup mode," which prevents the converter from overheating. In all, there are seven ways that the converter can be shut down, initiating a Startup Inhibit Period:

- Input Under-Voltage Lockout
- Input Over-Voltage Shutdown (not present in Eighth-brick)
- Output Over-Voltage Protection
- Over Temperature Shutdown
- Current Limit
- Short Circuit Protection
- Turned off by the ON/OFF input

Figure F shows three turn-on scenarios, where a Startup Inhibit Period is initiated at  $t_0$ ,  $t_1$ , and  $t_2$ :

Before time  $t_0$ , when the input voltage is below the UVL threshold, the unit is disabled by the Input Under-Voltage Lockout feature.

When the input voltage rises above the UVL threshold, the Input Under-Voltage Lockout is released, and a Startup Inhibit Period is initiated. At the end of this delay, the ON/OFF pin is evaluated, and since it is active, the unit turns on.

At time  $t_1$ , the unit is disabled by the ON/OFF pin, and it cannot be enabled again until the Startup Inhibit Period has elapsed.

When the ON/OFF pin goes high after  $t_2$ , the Startup Inhibit Period has elapsed, and the output turns on within the typical Turn-On Time.

**RoHS Compliance:** The EU led RoHS (Restriction of Hazardous Substances) Directive bans the use of Lead, Cadmium, Hexavalent Chromium, Mercury, Polybrominated Biphenyls (PBB), and Polybrominated Diphenyl Ether (PBDE) in Electrical and Electronic Equipment. This SynQor product is available as 5/6 RoHS compliant (product with lead) or 6/6 RoHS compliant. For more information please refer to SynQor's RoHS addendum available at our [RoHS Compliance / Lead Free Initiative](#) web page or e-mail us at [rohs@synqor.com](mailto:rohs@synqor.com).

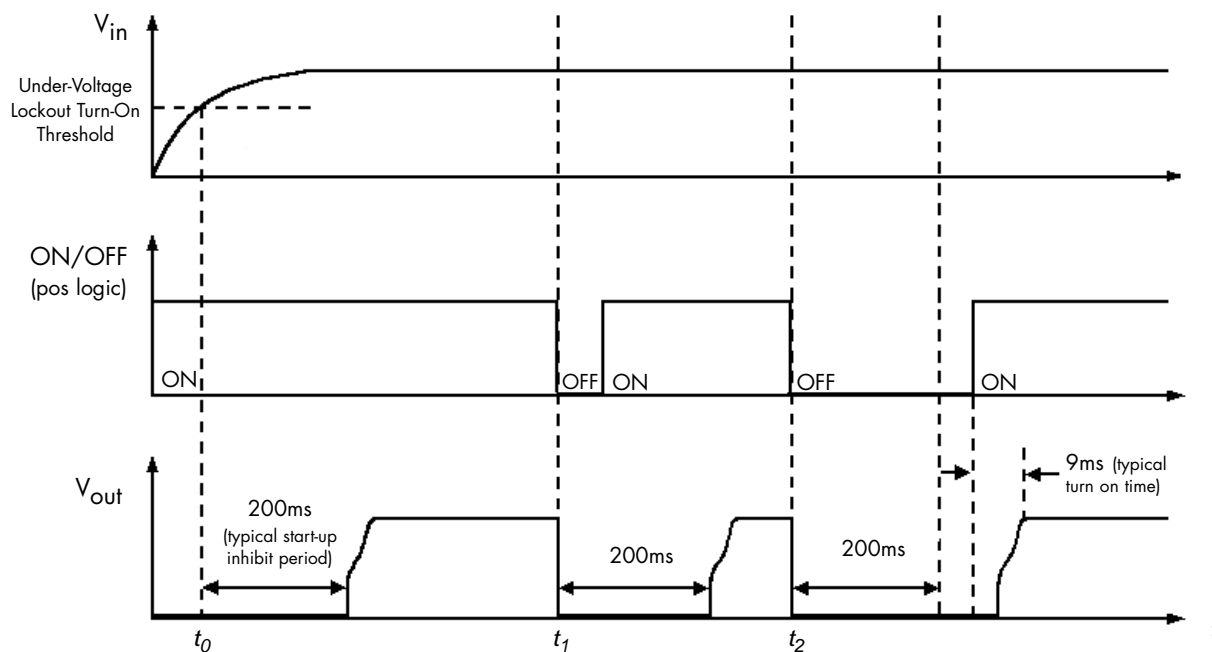

Figure F: Startup Inhibit Period (turn-on time not to scale)



# Technical Specification

**Input: 35-75 V**  
**Output: 1.2 V**  
**Current: 15 A (18W)**  
**Package: Eighth-brick**

## PART NUMBERING SYSTEM

The part numbering system for SynQor's PowerQor DC/DC converters follows the format shown in the example below.

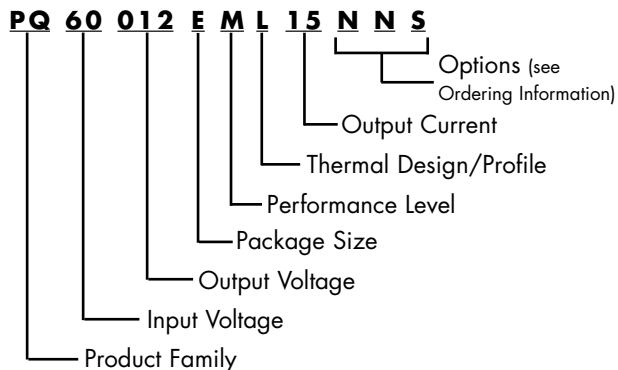

The first 12 characters comprise the base part number and the last 3 characters indicate available options. Although there are no default values for enable logic and pin length, the most common options are negative logic and 0.145" pins. These part numbers are more likely to be readily available in stock for evaluation and prototype quantities. A "-G" suffix indicates 6/6 RoHS compliance.

## Application Notes

A variety of application notes and technical white papers can be downloaded in pdf format from our [website](#).

## PATENTS (additional patent applications may be filed)

SynQor holds the following patents, one or more of which might apply to this product:

|           |           |           |           |
|-----------|-----------|-----------|-----------|
| 5,999,417 | 6,222,742 | 6,545,890 | 6,577,109 |
| 6,594,159 | 6,731,520 | 6,894,468 | 6,896,526 |
| 6,927,987 | 7,050,309 | 7,072,190 | 7,085,146 |
| 7,119,524 | 7,269,034 | 7,272,021 | 7,272,023 |

## Contact SynQor for further information:

**Phone:** 978-849-0600  
**Toll Free:** 888-567-9596  
**Fax:** 978-849-0602  
**E-mail:** [power@synqor.com](mailto:power@synqor.com)  
**Web:** [www.synqor.com](http://www.synqor.com)  
**Address:** 155 Swanson Road  
 Boxborough, MA 01719  
 USA

## ORDERING INFORMATION

The tables below show the valid model numbers and ordering options for converters in this product family. When ordering SynQor converters, please ensure that you use the complete 15 character part number consisting of the 12 character base part number and the additional 3 characters for options. To order 6/6 RoHS compliant product please add a "-G" suffix.

| Model Number             | Input Voltage | Output Voltage | Max Output Current |
|--------------------------|---------------|----------------|--------------------|
| <b>PQ60010EM w 15xyz</b> | 35 - 75 V     | 1.0 V          | 15 A               |
| <b>PQ60012EM w 15xyz</b> | 35 - 75 V     | 1.2 V          | 15 A               |
| <b>PQ60015EM w 15xyz</b> | 35 - 75 V     | 1.5 V          | 15 A               |
| <b>PQ60018EM w 15xyz</b> | 35 - 75 V     | 1.8 V          | 15 A               |
| <b>PQ60025EM w 15xyz</b> | 35 - 75 V     | 2.5 V          | 15 A               |
| <b>PQ60033EM w 15xyz</b> | 35 - 75 V     | 3.3 V          | 15 A               |
| <b>PQ60050EM w 10xyz</b> | 35 - 75 V     | 5.0 V          | 10 A               |
| <b>PQ60120EM w 04xyz</b> | 35 - 75 V     | 12 V           | 4.2 A              |

Modules above can be ordered with an increased bottom side board clearance and a slightly larger total height (see page 2 for dimensions). To order replace EML in the part number with EMA. There are no other differences from the EML units.

The following option choices must be included in place of the w x y z spaces in the model numbers listed above.

| Options Description: w x y z                 |                              |  |              |
|--|------------------------------|--|--------------|
| Thermal Design                               | Enable Logic                 | Pin Length   | Feature Set  |
| A - Open Frame<br>L - Low Profile Open Frame | P - Positive<br>N - Negative | K - 0.110"<br>N - 0.145"<br>R - 0.180"<br>Y - 0.250" | S - Standard |

### Warranty

SynQor offers a three (3) year limited warranty. Complete warranty information is listed on our [website](#) or is available upon request from SynQor.

Information furnished by SynQor is believed to be accurate and reliable. However, no responsibility is assumed by SynQor for its use, nor for any infringements of patents or other rights of third parties which may result from its use. No license is granted by implication or otherwise under any patent or patent rights of SynQor.