

PLEASE CHECK WWW.MOLEX.COM FOR LATEST PART INFORMATION

Part Number: [0395224010](#)
Status: **Active**
Description: 5.00mm (.197") Pitch Eurostyle™ Horizontal PCB Header, Surface Mount Compatible, 10 Circuits

Documents:

[3D Model](#) [Product Specification PS-39500-001 \(PDF\)](#)
[Drawing \(PDF\)](#) [RoHS Certificate of Compliance \(PDF\)](#)

General

Product Family	Terminal Blocks
Series	39522
Application	Wire-to-Board
Component Type	PCB Header
Product Literature Order No	USA-355
Product Name	ESE, Eurostyle™ Pluggable
Type	Euro Block

Physical

Circuits (Loaded)	10
Entry Angle	N/A
Lock to Mating Part	Yes
Number of Rows	1
Orientation	Horizontal
PC Tail Length (in)	0.154 In
PC Tail Length (mm)	3.90 mm
PCB Thickness Recommended (in)	0.125 In
PCB Thickness Recommended (mm)	3.20 mm
Panel Mount	No
Pitch - Mating Interface (in)	0.197 In
Pitch - Mating Interface (mm)	5.00 mm
Polarized to Mating Part	Yes
Shrouded	Closed Ends
Stackable	No
Surface Mount Compatible (SMC)	Yes
Temperature Range - Operating	-40°C to +140°C
Wire Size AWG	N/A

Electrical

Current - Maximum per Contact	15A
Voltage - Maximum	300V

Material Info

Reference - Drawing Numbers

Product Specification	PS-39500-001
Sales Drawing	SD-39501-002, SD-39522-001

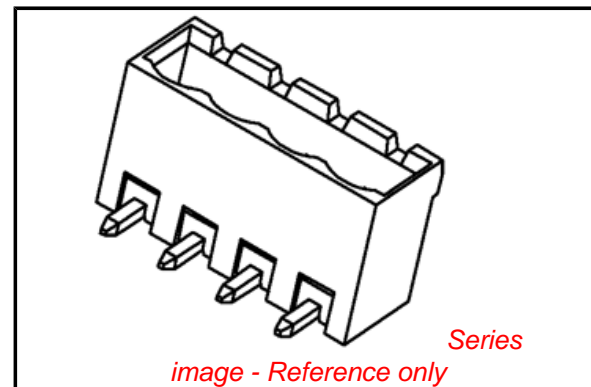

EU RoHS

**ELV and RoHS
Compliant**
REACH SVHC
 Not Reviewed
**Halogen-Free
Status**

China RoHS



Not Reviewed

**Need more information on product
environmental compliance?**

Email productcompliance@molex.com
 For a multiple part number RoHS Certificate of
 Compliance, [click here](#)

Please visit the [Contact Us](#) section for any
 non-product compliance questions.

Search Parts in this Series

[39522Series](#)

Mates With

[39520](#) Horizontal Plug, [39523](#) Vertical
 Plug, Most 5.00mm (.197") Pitch Industry
 Standard Plugs

3950X SERIES
3.50mm HEADERS

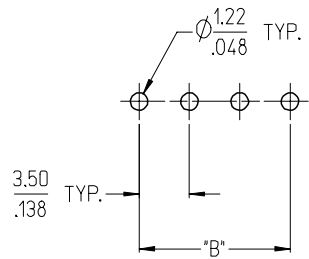

3952X & 3954X SERIES
5.00mm HEADERS
5.00mm 10 AMP FIXED

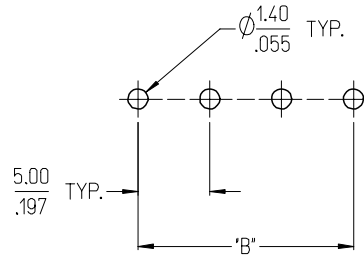

3953X SERIES
5.08mm HEADERS

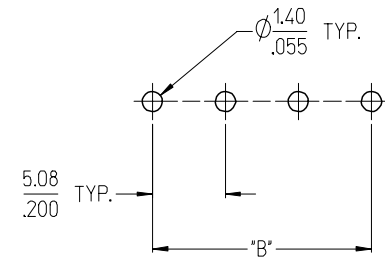

3951X SERIES
3.81mm HEADERS

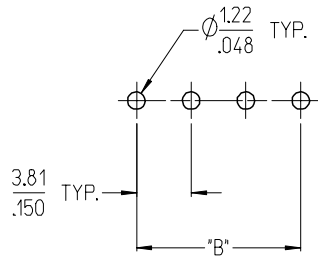

3954X SERIES
5.00mm 15 AMP FIXED

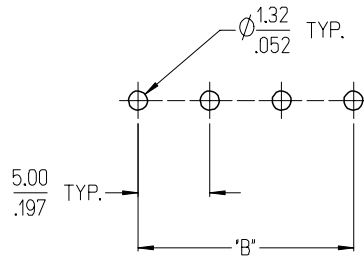

3954X SERIES
5.08mm 15 AMP FIXED

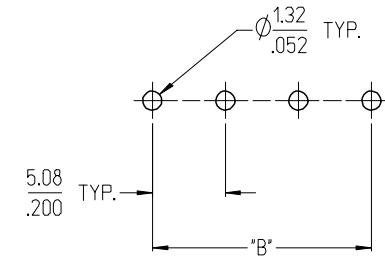

NOTES:

- REFER TO INDIVIDUAL PRODUCT SALES DRAWINGS FOR "B" DIMENSION.
- DOES NOT APPLY TO DUAL LEVEL HEADERS, SERIES 39528 AND 39538.
- TYP. = TYPICAL.

INITIAL RELEASE
EC NO: ETC2007-0096
DRWN: CLYORK 2006/10/02
CHKD: JMACNEIL 2006/10/04
APPR: JMACNEIL 2006/10/04

QUALITY SYMBOLS
 = 0
 = 0.05
 DESCRIPTION
 REV

GENERAL TOLERANCES (UNLESS SPECIFIED)	
	MM/INCH
4 PLACES	± --- ± ---
3 PLACES	± --- ± .005
2 PLACES	± 0.13 ± .01
1 PLACE	± 0.3 ± ---
ANGULAR ± 2 °	
DRAFT WHERE APPLICABLE MUST REMAIN WITHIN DIMENSIONS	

DIMENSION STYLE	
MM/IN	
DRAWN BY	DATE
C. YORK	2006/08/25
CHECKED BY	DATE
J. MACNEIL	2006/08/25
APPROVED BY	DATE
J. MACNEIL	2006/08/25
MATERIAL NO.	
--	

SCALE	DESIGN UNITS	THIRD ANGLE PROJECTION
3:1	INCH	
TITLE		
RECOMMENDED PCB LAYOUT FOR ESE TERMINAL BLOCKS		
MOLEX INCORPORATED		
DOCUMENT NO.	SHEET NO.	
SD-39501-002	1 OF 1	
SIZE B THIS DRAWING CONTAINS INFORMATION THAT IS PROPRIETARY TO MOLEX INCORPORATED AND SHOULD NOT BE USED WITHOUT WRITTEN PERMISSION		

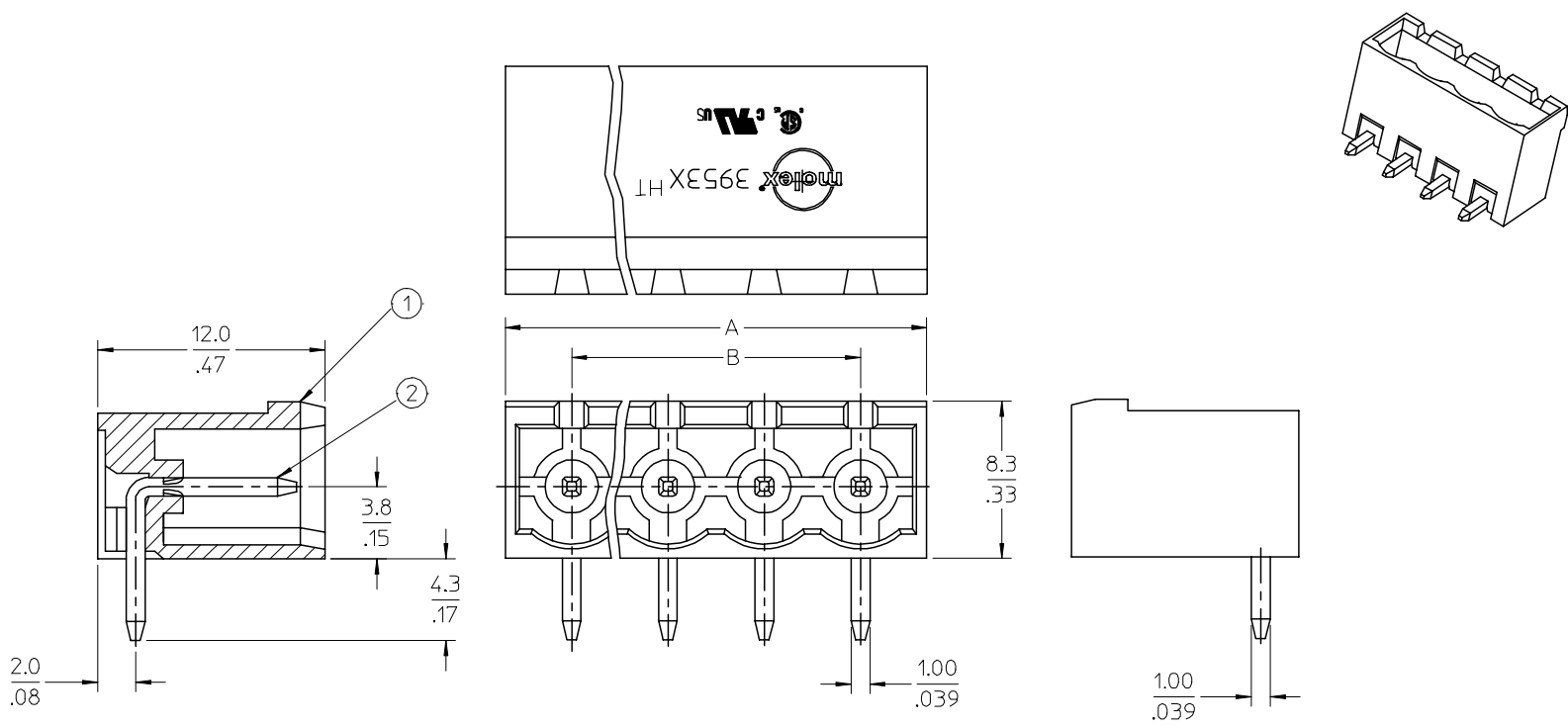

SPECIFICATIONS:

1. Material:
 - (1). Body: PA46
 - (2). Pin: Brass
2. Wire range: N/A
3. Electrical rating: 300V, 15A.
4. Wire strip length: N/A
5. Operating temperature: -40C to +140C.
6. Max torque: N/A
7. Insulation resistance: DC 500V, 500M.
8. Dielectric withstand: AC 2500V for 1 minute.
9. Breakdown voltage: 4000V.
10. $A = (N \times P) + 2.0\text{mm}$
11. $B = (N - 1) \times P$
12. P (PITCH) = 5.0mm (.197").
13. N = Number of positions available 2 through 24.

ENTER DESCRIPTION EC NO: NEO2006-0310 DRWNL: LROTHAUS 2006/01/09 CHKD: CYORK 2006/01/09 APPR: JPAMLICK 2006/01/10	QUALITY SYMBOLS = 0 = 0	GENERAL TOLERANCES (UNLESS SPECIFIED)		DIMENSION STYLE	SCALE	DESIGN UNITS	THIRD ANGLE PROJECTION	
				MM/IN	4:1	INCH		
				MM	INCH	DRAWN BY	DATE	TITLE
		4 PLACES	± ---	± .0015	LROTHAUS	12/6/05	5.0MM, EURO HEADER, RIGHT ANGLE, HI-TEMP	
3 PLACES	± 0.038	± .005	CHECKED BY	DATE	MOLEX INCORPORATED			
2 PLACES	± 0.13	± .01	C. YORK	01/06/06				
1 PLACE	± 0.3	± ---	APPROVED BY	DATE	SD-39522-001			
ANGULAR ± 2 °								
DRAFT WHERE APPLICABLE MUST REMAIN WITHIN DIMENSIONS			MATERIAL NO.	DOCUMENT NO.	SHEET NO.			
			SEE CHART	SD-39522-001	1 OF 1			
			SIZE B	THIS DRAWING CONTAINS INFORMATION THAT IS PROPRIETARY TO MOLEX INCORPORATED AND SHOULD NOT BE USED WITHOUT WRITTEN PERMISSION				

10 9 8 7 6 5 4 3 2 1

Description	Circuit size	Material Numbers												Dimensional Information				
		Black						Green										
		100% Tin			30 u" Gold			100% Tin			30 u" Gold			Dim. A		Dim B		
		Printing Options			Printing Options			Printing Options			Printing Options							
None	10A	11A	None	10A	11A	None	10A	11A	None	10A	11A	None	10A	11A	mm	inch	mm	inch
5.0mm, Euro Header, Right Angle, High Temp	2	395224002	395224102	395224202	395224502	395224602	395224702	395229002	395229102	395229202	395229502	395229602	395229702	12.00	0.472	5.00	0.197	
5.0mm, Euro Header, Right Angle, High Temp	3	395224003	395224103	395224203	395224503	395224603	395224703	395229003	395229103	395229203	395229503	395229603	395229703	17.00	0.669	10.00	0.394	
5.0mm, Euro Header, Right Angle, High Temp	4	395224004	395224104	395224204	395224504	395224604	395224704	395229004	395229104	395229204	395229504	395229604	395229704	22.00	0.866	15.00	0.591	
5.0mm, Euro Header, Right Angle, High Temp	5	395224005	395224105	395224205	395224505	395224605	395224705	395229005	395229105	395229205	395229505	395229605	395229705	27.00	1.063	20.00	0.787	
5.0mm, Euro Header, Right Angle, High Temp	6	395224006	395224106	395224206	395224506	395224606	395224706	395229006	395229106	395229206	395229506	395229606	395229706	32.00	1.260	25.00	0.984	
5.0mm, Euro Header, Right Angle, High Temp	7	395224007	395224107	395224207	395224507	395224607	395224707	395229007	395229107	395229207	395229507	395229607	395229707	37.00	1.457	30.00	1.181	
5.0mm, Euro Header, Right Angle, High Temp	8	395224008	395224108	395224208	395224508	395224608	395224708	395229008	395229108	395229208	395229508	395229608	395229708	42.00	1.654	35.00	1.378	
5.0mm, Euro Header, Right Angle, High Temp	9	395224009	395224109	395224209	395224509	395224609	395224709	395229009	395229109	395229209	395229509	395229609	395229709	47.00	1.850	40.00	1.575	
5.0mm, Euro Header, Right Angle, High Temp	10	395224010	395224110	395224210	395224510	395224610	395224710	395229010	395229110	395229210	395229510	395229610	395229710	52.00	2.047	45.00	1.772	
5.0mm, Euro Header, Right Angle, High Temp	11	395224011	395224111	395224211	395224511	395224611	395224711	395229011	395229111	395229211	395229511	395229611	395229711	57.00	2.244	50.00	1.969	
5.0mm, Euro Header, Right Angle, High Temp	12	395224012	395224112	395224212	395224512	395224612	395224712	395229012	395229112	395229212	395229512	395229612	395229712	62.00	2.441	55.00	2.165	
5.0mm, Euro Header, Right Angle, High Temp	13	395224013	395224113	395224213	395224513	395224613	395224713	395229013	395229113	395229213	395229513	395229613	395229713	67.00	2.638	60.00	2.362	
5.0mm, Euro Header, Right Angle, High Temp	14	395224014	395224114	395224214	395224514	395224614	395224714	395229014	395229114	395229214	395229514	395229614	395229714	72.00	2.835	65.00	2.559	
5.0mm, Euro Header, Right Angle, High Temp	15	395224015	395224115	395224215	395224515	395224615	395224715	395229015	395229115	395229215	395229515	395229615	395229715	77.00	3.031	70.00	2.756	
5.0mm, Euro Header, Right Angle, High Temp	16	395224016	395224116	395224216	395224516	395224616	395224716	395229016	395229116	395229216	395229516	395229616	395229716	82.00	3.228	75.00	2.953	
5.0mm, Euro Header, Right Angle, High Temp	17	395224017	395224117	395224217	395224517	395224617	395224717	395229017	395229117	395229217	395229517	395229617	395229717	87.00	3.425	80.00	3.150	
5.0mm, Euro Header, Right Angle, High Temp	18	395224018	395224118	395224218	395224518	395224618	395224718	395229018	395229118	395229218	395229518	395229618	395229718	92.00	3.622	85.00	3.346	
5.0mm, Euro Header, Right Angle, High Temp	19	395224019	395224119	395224219	395224519	395224619	395224719	395229019	395229119	395229219	395229519	395229619	395229719	97.00	3.819	90.00	3.543	
5.0mm, Euro Header, Right Angle, High Temp	20	395224020	395224120	395224220	395224520	395224620	395224720	395229020	395229120	395229220	395229520	395229620	395229720	102.00	4.016	95.00	3.740	
5.0mm, Euro Header, Right Angle, High Temp	21	395224021	395224121	395224221	395224521	395224621	395224721	395229021	395229121	395229221	395229521	395229621	395229721	107.00	4.213	100.00	3.937	
5.0mm, Euro Header, Right Angle, High Temp	22	395224022	395224122	395224222	395224522	395224622	395224722	395229022	395229122	395229222	395229522	395229622	395229722	112.00	4.409	105.00	4.134	
5.0mm, Euro Header, Right Angle, High Temp	23	395224023	395224123	395224223	395224523	395224623	395224723	395229023	395229123	395229223	395229523	395229623	395229723	117.00	4.606	110.00	4.331	
5.0mm, Euro Header, Right Angle, High Temp	24	395224024	395224124	395224224	395224524	395224624	395224724	395229024	395229124	395229224	395229524	395229624	395229724	122.00	4.803	115.00	4.528	

SEE SHEET 1 EC NO: NEC2006-0310 DRWNL: LROTHAUS 2006/01/09 CHKDC: CYORK 2006/01/09 APPR: J.P.A.M.L.C.K 2006/01/10	QUALITY SYMBOLS ▽=0 ▽=0	GENERAL TOLERANCES (UNLESS SPECIFIED)		DIMENSION STYLE		SCALE	DESIGN UNITS	THIRD ANGLE PROJECTION
				MM/IN		4:1	INCH	
				DRAWN BY DATE		TITLE		
				CHECKED BY DATE		MOLEX INCORPORATED		
		APPROVED BY DATE		MATERIAL NO.		DOCUMENT NO.		SHEET NO.
		ANGULAR ± 2 °		SEE CHART		SD-39522-001		2 OF 2
		DRAFT WHERE APPLICABLE MUST REMAIN WITHIN DIMENSIONS		THIS DRAWING CONTAINS INFORMATION THAT IS PROPRIETARY TO MOLEX INCORPORATED AND SHOULD NOT BE USED WITHOUT WRITTEN PERMISSION				

9 8 7 6 5 4 3 2 1