



Product Specifications
January 1996

(1 of 4)

800 to 2700 MHz Broadband Driver Amplifier

Features

- ❑ +17.5 dBm Output Power
- ❑ Low Current: 70 mA, Typ.
- ❑ 800 – 2700 MHz Operation
- ❑ Single +3V to +6V Supply
- ❑ Input and Output Matched to 50Ω, DC Blocked
- ❑ Low-Cost SOIC-8 Plastic Package

Applications

- ❑ Power Amplifier Drivers
- ❑ Diode-Ring Mixer Buffers
- ❑ PCS Medium Power Amplifiers
- ❑ Medium Power WLANs
- ❑ Base Station Receivers

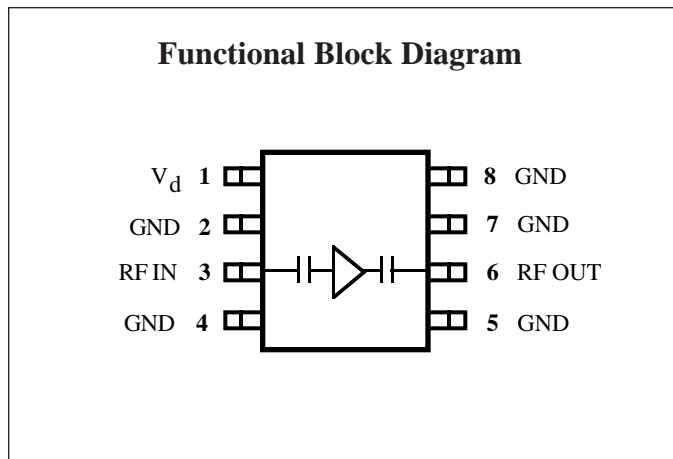

Description

The Celeritek CMM2306 is a premium performance, pin-for-pin compatible second source for the TriQuint® 9132 and the Mini-Circuits® VNA. Providing higher gain and lower noise figure than either of the existing standard amplifiers at 25% less drain current, the CMM2306 is an excellent choice for power sensitive applications, while delivering more design margin than either of the existing alternatives. This device

will drop into existing sockets and offers the same single supply, broadband, 50Ω matched and DC blocked input and output features and performance, that the industry has come to expect, with much higher efficiency and lower current.

Packaged in a low-cost surface mount SOIC-8 package, the CMM2306 offers superior performance to existing alternatives at a competitive price.

Absolute Maximum Ratings

Parameter	Rating	Parameter	Rating	Parameter	Rating
Drain Voltage (+V _d)	+7 V	Power Dissipation	1.0 W	Operating Temperature	-40°C to +80°C
Drain Current (I _d)	150 mA	Thermal Resistance	55°C/W	Channel Temperature	175°C
RF Input Power	15 dBm	Storage Temperature	-65°C to +150°C	Soldering Temperature	260°C for 5 Sec

Recommended Operating Conditions

Parameter	Typ	Units	Parameter	Typ	Units
Drain Voltage (+V _d)	3.0 to 6.0	Volts	Operating Temperature (PC Board)	-40 to +70	°C

Electrical Characteristics

The following specifications are guaranteed at room temperature with drain voltage (+V_d) = 5.0 V ±5% at 2.5 GHz.

Parameter	Condition	Min	Typ	Max	Units
Frequency Range		800		2700	MHz
Small Signal Gain		18.5	20		dB
Noise Figure			3.5		dB
Power Output @ 1 dB Compression		15.5	17		dBm
Output 3rd Order Intercept			27		dBm
Input Return Loss			8		dB
Output Return Loss			10		dB
DC Supply Current			70	80	mA
Supply Voltage		3	5	6	V

TriQuint and Mini-Circuits are trademarks of their respective corporations.

Connection Diagram and Pin Description

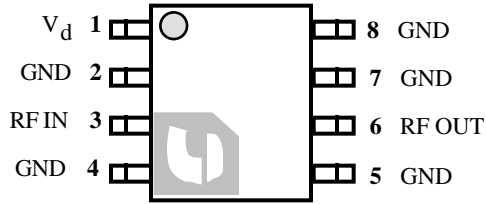

Pin #	Name	Description
1	$+V_d$	Drain voltage. Connect to positive supply.
2	GND	Ground.
3	RF IN	RF input (Internally DC blocked).
4	GND	Ground.
5	GND	Ground.
6	RF OUT	RF output (Internally DC blocked).
7	GND	Ground.
8	GND	Ground.

Typical Performance

The following typical performance parameters were tested in the test circuit shown at room temperature and with a drain voltage ($+V_d$) = 5 V, unless otherwise specified.

Test Circuit Diagram

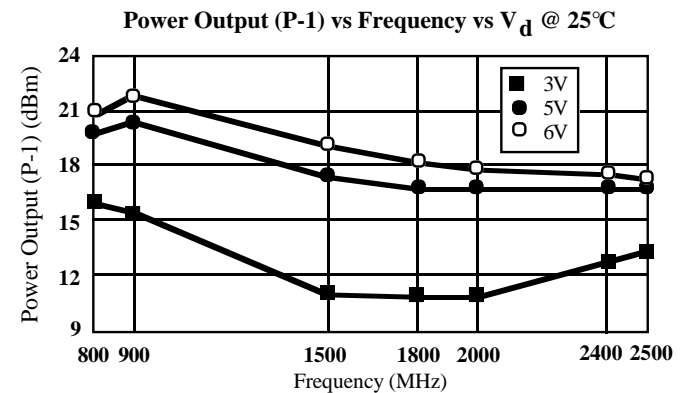
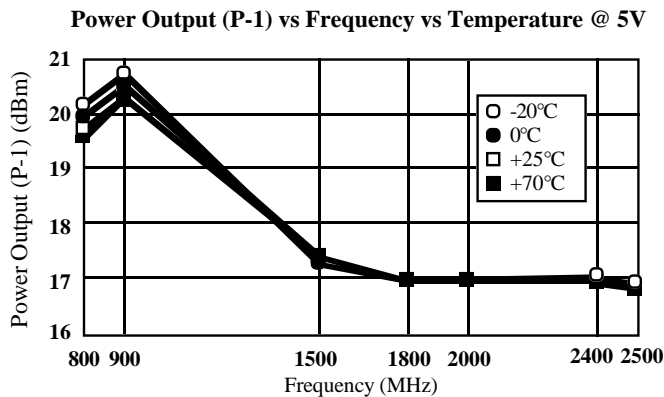
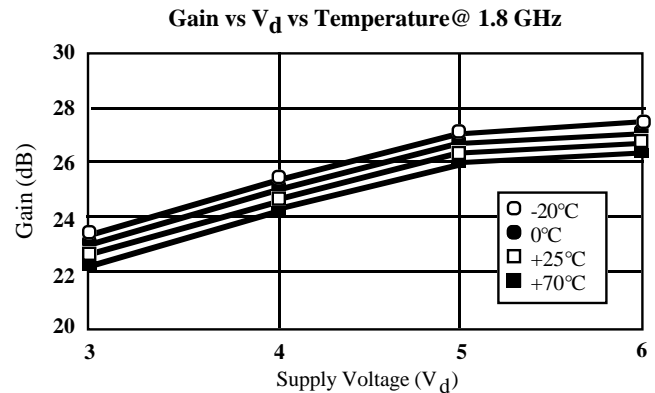
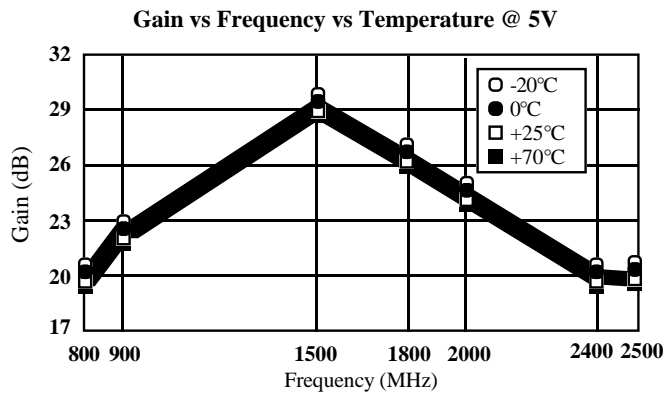
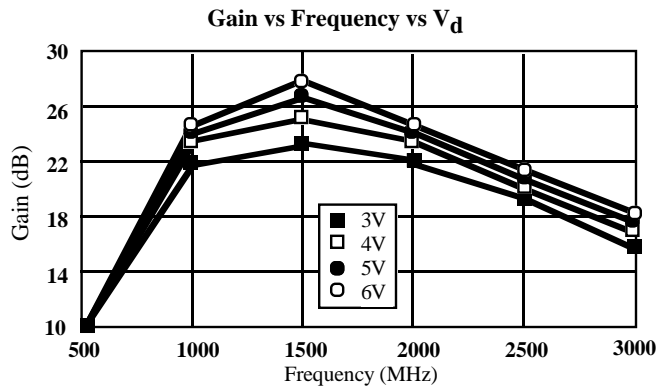
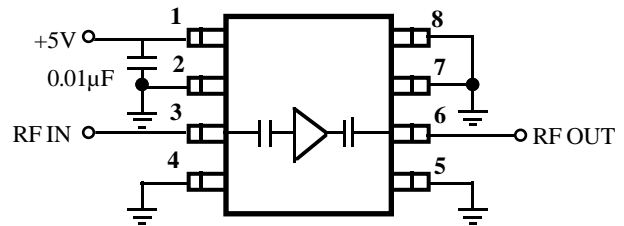



Typical Performance (Continued)

Noise Figure vs Frequency vs V_d @ 25°C

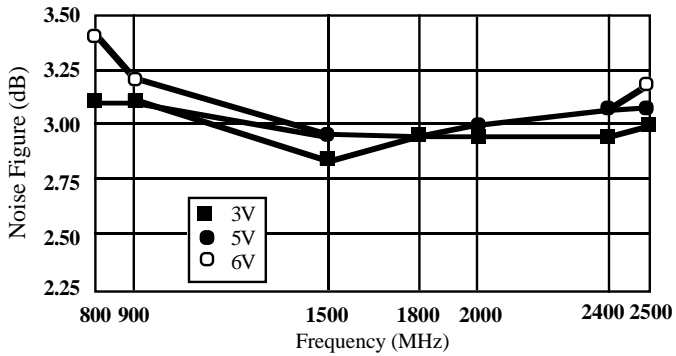

OIP3 vs Frequency vs V_d @ 25°C

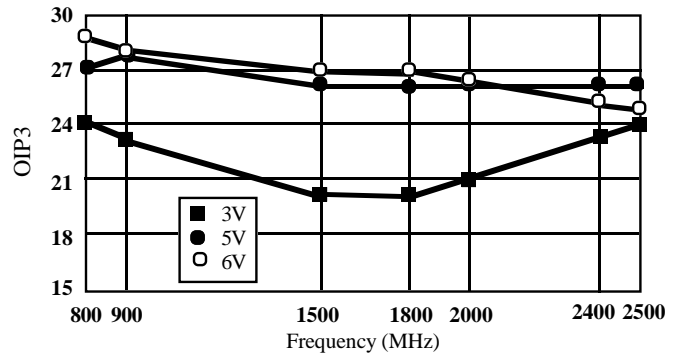

Noise Figure vs Frequency vs Temperature @ 5V

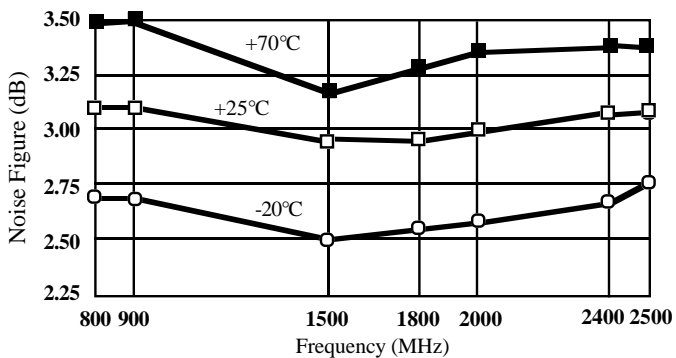

OIP3 vs Frequency vs Temperature @ 5V

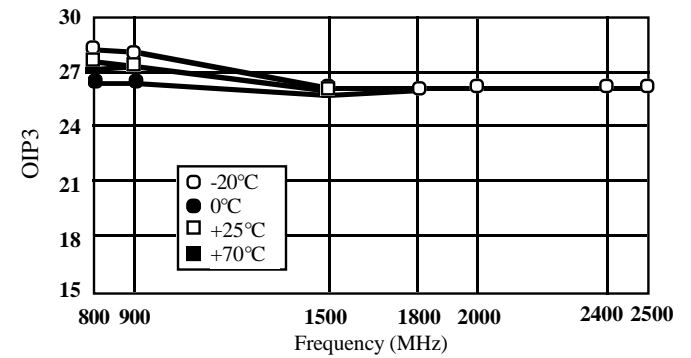

S11 vs Frequency vs V_d

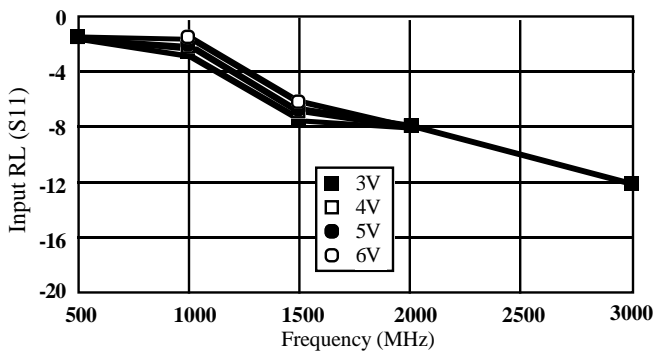

S22 vs Frequency vs V_d

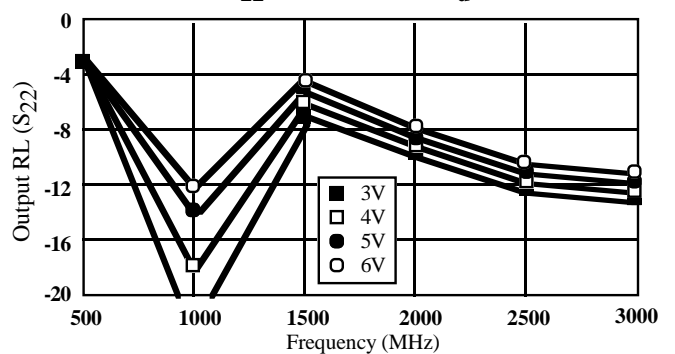

Power In vs Power Out & Efficiency

$V_d = 4.8$ V & Frequency = 1.88 GHz

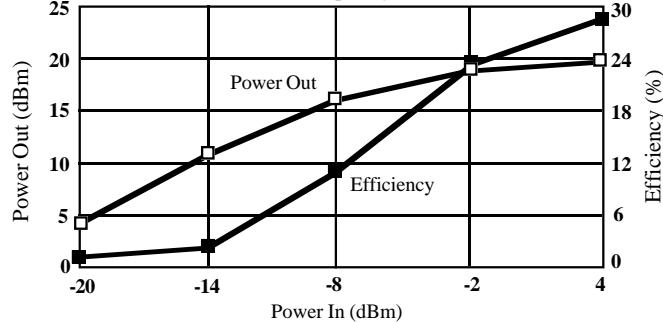

S12 vs Frequency vs V_d

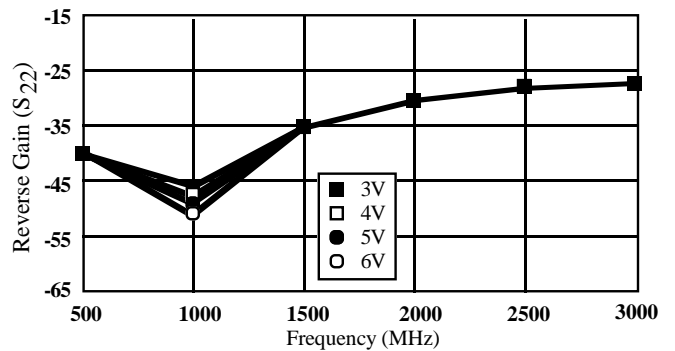

Test Configuration and Evaluation

Celeritek tests the CMM2306 on an FR4 PC test board. FR4 was chosen for its low loss characteristics at frequencies up to 2.5GHz. Plated through hole connections from the top of the board to the backside ground plane minimizes inductance in the ground connections. These through hole connections are as close as possible to each ground pin.

For evaluation purposes Celeritek offers a prototype evaluation board (PB-CMM2306-AJ) for the CMM2306. Please call the factory or a local representative for more information.

Handling Precaution

Microwave devices are sensitive to electrostatic discharge. Proper precautions should be taken to avoid ESD damage.

Physical Dimensions

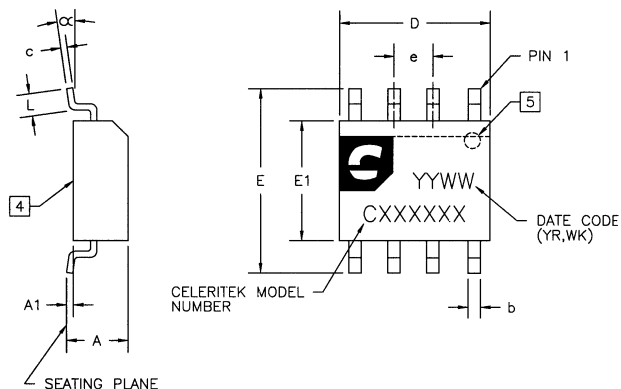

NOTES:(UNLESS OTHERWISE SPECIFIED)

1. DIMENSIONS ARE IN MILLIMETERS[INCHES].
2. LEAD MATERIAL: COPPER
3. BODY MATERIAL: PLASTIC (EPOXY).
- [4] COUNTRY OF ORIGIN, IF OTHER THAN U.S., SHALL BE MARKED ON THIS SURFACE.
- [5] PIN 1 IDENTIFICATION IS A DOT OR BEVELED EDGE.

DIMENSION	MINIMUM	NOMINAL	MAXIMUM
A	1.35[0.053]	1.63[0.064]	1.75[0.069]
A1	0.10[0.004]	0.15[0.006]	0.20[0.008]
b	0.35[0.014]		0.45[0.018]
c	0.19[0.007]		0.22[0.009]
D	4.80[0.188]	4.90[0.193]	5.00[0.197]
E	5.80[0.228]	5.99[0.236]	6.20[0.244]
E1	3.80[0.150]	3.91[0.154]	4.00[0.158]
e		1.27[0.050]	
L	0.508[0.020]	0.64[0.025]	1.143[0.045]
alpha	0°		8°

Ordering Information

The CMM2306 is available in a surface mount SOIC-8 plastic package.

Part Number for Ordering

CMM2306-AJ

CMM2306-AJ-000T

Package

SOIC-8 surface mount narrow body plastic package

SOIC-8 package in tape and reel

Celeritek reserves the right to make changes without further notice to any products herein. Celeritek makes no warranty, representation or guarantee regarding the suitability of its products for any particular purpose, nor does Celeritek assume any liability arising out of the application or use of any product or circuit, and specifically disclaims any and all liability, including without limitation consequential or incidental damages. "Typical" parameters can and do vary in different applications. All operating parameters, including "Typicals" must be validated for each customer application by customer's technical experts. Celeritek does not convey any license under its patent rights nor the rights of others. Celeritek products are not designed, intended, or authorized for use as components in systems intended for surgical implant into the body, or other applications intended to support or sustain life, or for any other application in which the failure of the Celeritek product could create a situation where personal injury or death may occur. Should Buyer purchase or use Celeritek products for any such unintended or unauthorized application, Buyer shall indemnify and hold Celeritek and its officers, employees, subsidiaries, affiliates, and distributors harmless against all claims, costs, damages, and expenses, and reasonable attorney fees arising out of, directly or indirectly, any claim of personal injury or death associated with such unintended or unauthorized use, even if such claim alleges that Celeritek was negligent regarding the design or manufacture of the part. Celeritek is a registered trademark of Celeritek, Inc. Celeritek, Inc. is an Equal Opportunity/Affirmative Action Employer.

Adjacent Channel Power $\pi/4$ DQPSK Modulation, $V_d = 4.8$ V

