

Coaxial High Pass Filter

ZX75HP-2400+

50Ω 2400 to 5925 MHz

The Big Deal

- Low insertion loss
- Sharp rejection
- Excellent passband VSWR up to 5925 MHz
- Connectorized package



CASE STYLE: HY1239

Product Overview

ZX75HP-2400+ is a High pass filter in a rugged connectorized package covering 2400 to 5925 MHz. This filter has outstanding sharp rejection, low insertion loss and power handling for use in satellite communication.

Key Features

Feature	Advantages
Low insertion loss	Can be used in high performance applications.
Good rejection	This enables the filter to attenuate spurious signals and reject harmonics for broad band frequency.
Connectorized package	The connectorized package is easy to interface with other devices and well suited for test setups.

Notes

- A. Performance and quality attributes and conditions not expressly stated in this specification document are intended to be excluded and do not form a part of this specification document.
B. Electrical specifications and performance data contained in this specification document are based on Mini-Circuit's applicable established test performance criteria and measurement instructions.
C. The parts covered by this specification document are subject to Mini-Circuits standard limited warranty and terms and conditions (collectively, "Standard Terms"); Purchasers of this part are entitled to the rights and benefits contained therein. For a full statement of the Standard Terms and the exclusive rights and remedies thereunder, please visit Mini-Circuits' website at www.minicircuits.com/MCLStore/terms.jsp



Coaxial High Pass Filter

ZX75HP-2400+

50Ω 2400 to 5925 MHz



CASE STYLE: HY1239

Connectors	Model
SMA-F	ZX75HP-2400-S+

Features

- Low insertion loss
- Sharp rejection
- Excellent passband VSWR up to 5925 MHz
- Connectorized package

Applications

- Test and measurements
- Satellite communications
- Transmitter / Receiver

Electrical Specifications at 25°C

Parameter	F#	Frequency (MHz)	Min.	Typ.	Max.	Unit	
Stop Band	Rejection Loss	DC-F1	DC-2025	25	31.9	-	dB
	VSWR	DC-F1	DC-2025	-	20	-	:1
Pass Band	Insertion Loss	F2-F3	2400-5925	-	0.7	1.5	dB
	VSWR	F2-F3	2400-5925	-	1.37	1.67	:1

Maximum Ratings

Operating Temperature	-40°C to 85°C
Storage Temperature	-55°C to 100°C
RF Power Input	2 W

Permanent damage may occur if any of these limits are exceeded.

Functional Schematic

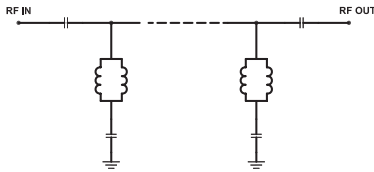

Typical Performance Data at 25°C

Frequency (MHz)	Insertion Loss (dB)	VSWR (:1)
1	91.26	6368.42
110	50.08	1620.00
380	40.05	535.68
2025	45.64	24.16
2054	30.63	20.98
2088	20.43	16.71
2140	10.02	8.54
2200	3.06	2.70
2300	0.85	1.18
2400	0.61	1.07
2500	0.52	1.14
2700	0.48	1.28
2900	0.44	1.26
3000	0.42	1.24
3200	0.40	1.17
3400	0.39	1.13
3600	0.40	1.19
4000	0.45	1.31
4500	0.45	1.29
5925	0.43	1.14

Typical Frequency Response

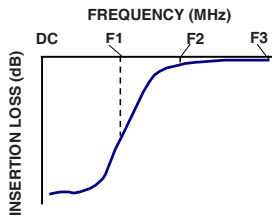

+RoHS Compliant
The +Suffix identifies RoHS Compliance. See our web site for RoHS Compliance methodologies and qualifications

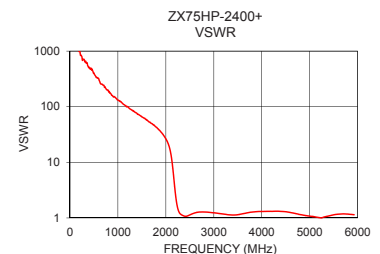
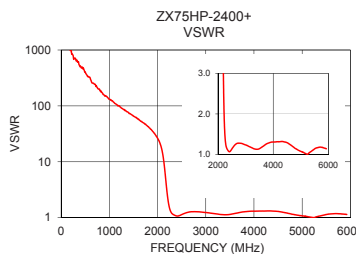
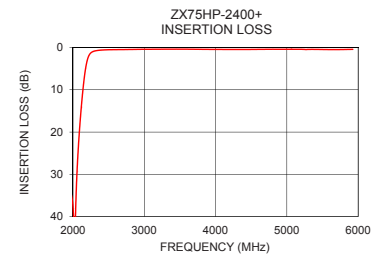
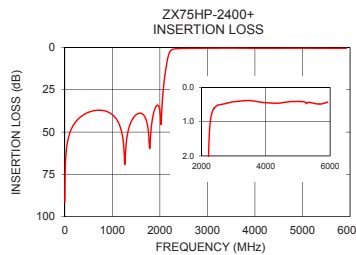

Notes

- Performance and quality attributes and conditions not expressly stated in this specification document are intended to be excluded and do not form a part of this specification document.
- Electrical specifications and performance data contained in this specification document are based on Mini-Circuits' applicable established test performance criteria and measurement instructions.
- The parts covered by this specification document are subject to Mini-Circuits standard limited warranty and terms and conditions (collectively, "Standard Terms"); Purchasers of this part are entitled to the rights and benefits contained therein. For a full statement of the Standard Terms and the exclusive rights and remedies thereunder, please visit Mini-Circuits' website at www.minicircuits.com/MCLStore/terms.jsp



Coaxial Connections

PORT 1	SMA-Female
PORT 2	SMA-Female

Outline Drawing

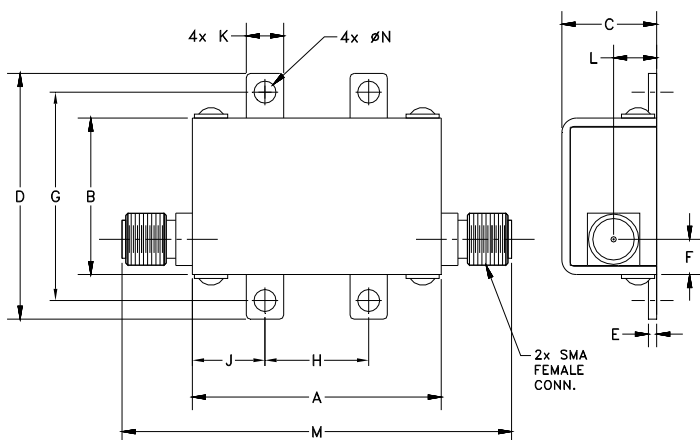

Outline Dimensions ($\frac{\text{inch}}{\text{mm}}$)

A	B	C	D	E	F	G
1.20	.75	.46	1.18	.04	.17	1.00
30.48	19.05	11.68	29.97	1.02	4.32	25.40
H	J	K	L	M	N	Wt.
.50	.35	.18	.21	1.88	.106	grams
12.70	8.89	4.57	5.28	47.75	2.69	35.0

Notes

- A. Performance and quality attributes and conditions not expressly stated in this specification document are intended to be excluded and do not form a part of this specification document.
 B. Electrical specifications and performance data contained in this specification document are based on Mini-Circuit's applicable established test performance criteria and measurement instructions.
 C. The parts covered by this specification document are subject to Mini-Circuits standard limited warranty and terms and conditions (collectively, "Standard Terms"); Purchasers of this part are entitled to the rights and benefits contained therein. For a full statement of the Standard Terms and the exclusive rights and remedies thereunder, please visit Mini-Circuits' website at www.minicircuits.com/MCLStore/terms.jsp

