

75 Ω BNC Style Connector

BNC75 Series

DDK Ltd.

Frequency Range

Characteristic Impedance

75 Ω

Lock Type
Bayonet



FEATURE

- 75 Ω of BNC style connector
- BNC style connectors can be mated.
- Bayonet coupling mechanism for reliable connection.

APPLICATIONS

Measurement Equipment, Broadcasting, HDTV

SPECIFICATIONS

Characteristic Impedance	75 Ω
Rated Voltage	500VAC(r.m.s.)
Dielectric Withstanding Voltage	1500V AC(r.m.s.)for1 minute
Insulation Resistance	1000M Ω Mim. at 500V DC
Contact Resistance	3m Ω Max.
V.S.W.R.	1.3 max. at DC to 1GHz
Operating Temperature	-55 ~ +85°C

* The specifications are typical but may not apply to all connectors. Please check the specifications on each item with its drawing from us when you use.

MATERIAL/FINISH



Item	Material / Finish
Shell (Body)	Copper Alloy / Ni or Ag Plating
Contact (Male)	Copper Alloy / Ag or Au Plating
Contact (Female)	Copper Alloy / Ag or Au Plating
Insulator	PTFE
Gasket	Silicon Rubber

© Please acknowledge that the specification etc. of this catalog might change by the improvement etc. without notice.
Moreover, the characteristic and the specification of the published product are the reference values.
Please confirm the content with the latest delivery specifications when you use the product.

▶ Straight Cable Plug

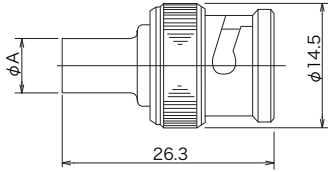

Part Number	Applicable Cable	φ A	Finish		Assembly Instruction	Crimp Tool
			Outer Conductor	Center Conductor		
BNC75-P-1.5CQEW-CF	1.5C-2W	5.50	Ni	Au		CR-H-1100
	1.5C-QEW					
BNC75-P-2.5CW-CR10B-CF	2.5C-XW	6.25	Ni	Au	1	CR-H-1105
	2.5C-2W					
BNC75-P-3CW-CR10B-CF	3C-2W	7.90	Ni	Au	1	CR-H-1132
	3C-2WS					

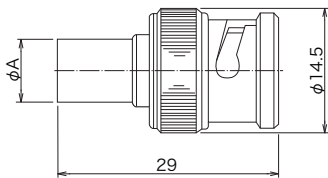

Part Number	Applicable Cable	φ A	Finish		Assembly Instruction
			Outer Conductor	Center Conductor	
BNC75-SP-3C2V-CR1-DA1	3C-2V	6.5	Ni	Au	

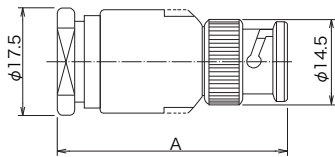

Part Number	Applicable Cable	φ A	Finish		Assembly Instruction
			Outer Conductor	Center Conductor	
BNC75-P-5-CF	5C-2V	37	Ag	Ag	
BNC75-P-5C2W-CF	5C-2W	37	Ni	Ag	3
BNC75-SP-5CFB-CF	5C-FB	39	Ni	Ag	

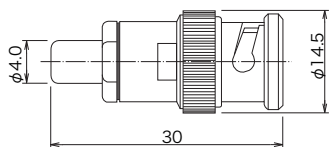

Part Number	Applicable Cable	Finish		Assembly Instruction	Crimp Tool
		Outer Conductor	Center Conductor		
BNC75-SP-1.5CCA-EXBV-CF	1.5CCA-EXBV	Ni	Au		CR-H-1101

▶ Straight Cable Jack

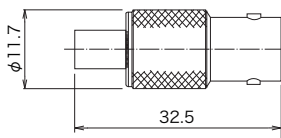

Part Number	Applicable Cable	Finish		Assembly Instruction	Crimp Tool
		Outer Conductor	Center Conductor		
BNC75-J-2.5C2W-CR10A-CF	2.5C-XW	Ni	Au		CR-H-1105
	2.5C-2W				

© Please acknowledge that the specification etc. of this catalog might change by the improvement etc. without notice.
 Moreover, the characteristic and the specification of the published product are the reference values.
 Please confirm the content with the latest delivery specifications when you use the product.

▶ Straight Bulkhead Cable Jack

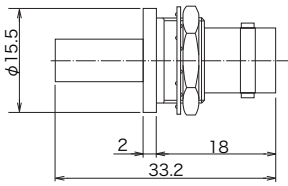

Part Number	Applicable Cable	Finish		Assembly Instruction	Crimp Tool
		Outer Conductor	Center Conductor		
BNC75-BJ-2.5C2W-CR1-CF	2.5C-2W	Ni	Au		
	2.5C-QEW				

▶ Straight Panel Cable Jack

Part Number	Applicable Cable	φ A	L	Finish		Assembly Instruction	Crimp Tool
				Outer Conductor	Center Conductor		
BNC75-PJ-3CW-CR10B-CF	3C-2WS	11.8	32.6	Ni	Au	4	CR-H1132
BNC75-PJ-3C2V-CR1-CF	3C-2V	11.3	30.0	Ni	Au		CR-H16776

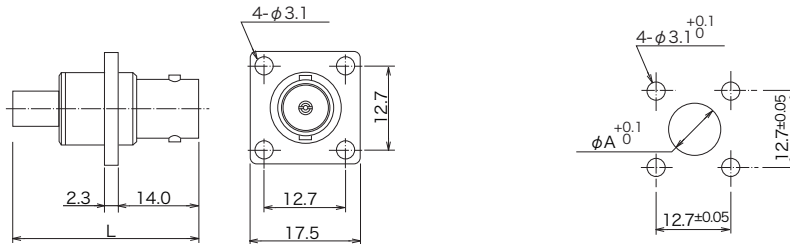

Panel Mounting Dimensions

Part Number	Applicable Cable	L	Finish		Assembly Instruction	Crimp Tool
			Outer Conductor	Center Conductor		
BNC75-PJ-1.5CCA-EXBV-CF	1.5CCA-EXBV	34.5	Ni	Au		CR-H1101
BNC75-PJ-1.5CV-CR2-CF	1.5C-2V	33.0	Ni	Au		CR-H1101
	1.5C-QEV					
BNC75-PJ-2.5V-CR-Ni-CF	2.5C-2V	34.5	Ni	Ag		CR-H1100

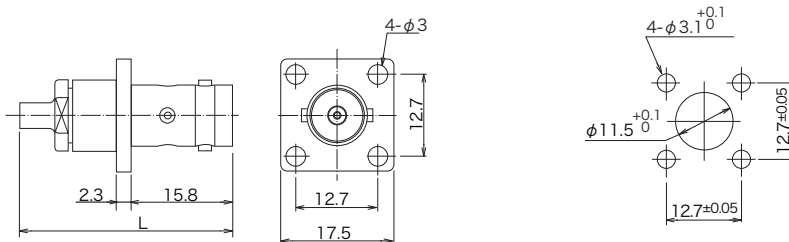

Panel Mounting Dimensions

© Please acknowledge that the specification etc. of this catalog might change by the improvement etc. without notice.
 Moreover, the characteristic and the specification of the published product are the reference values.
 Please confirm the content with the latest delivery specifications when you use the product.

▶ Receptacle Jack

Part Number	Finish	
	Outer Conductor	Center Conductor
BNC75-R-A-CF	Ni	Au

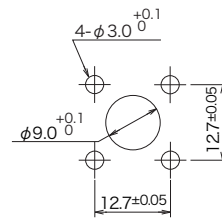
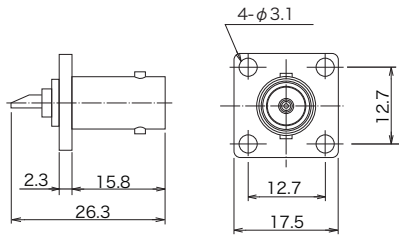

Panel Mounting Dimensions

© Please acknowledge that the specification etc. of this catalog might change by the improvement etc. without notice.
 Moreover, the characteristic and the specification of the published product are the reference values.
 Please confirm the content with the latest delivery specifications when you use the product.

▶ Assembly Instruction (1)

Parts Configuration

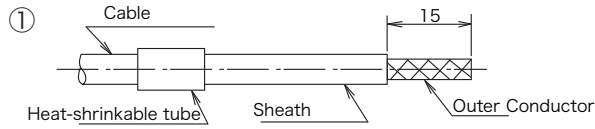
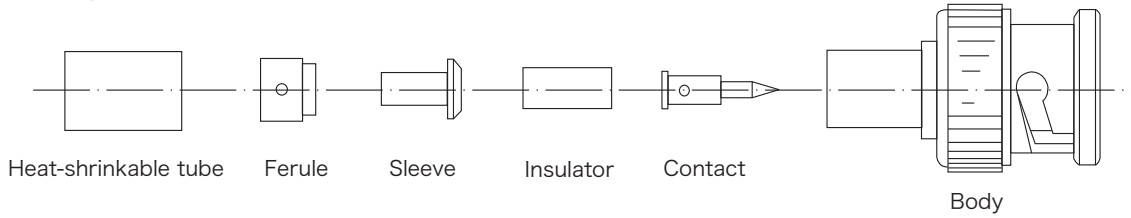

① Insert the heat-shrinkable tube into the cable and cut the cable as fig.1. Please be careful not to damage the outer conductor.

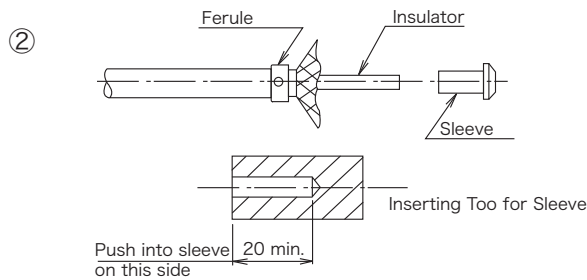

② Insert the ferule from the end of outer conductor to the sheath. Spread the top of outer conductor and insert the sleeve between insulator and outer conductor. To push the sleeve into the cable, please refer to the tool as fig.2. And cut the outer conductor along the sleeve.

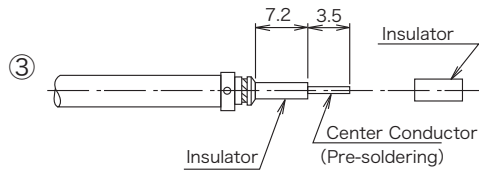

③ Cut the insulator and center conductor as fig.3. Cut the center conductor after pre-soldering.

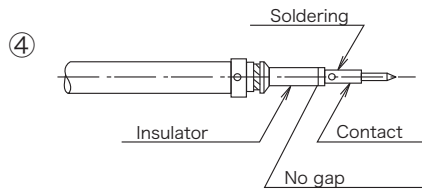

④ Insert the insulator and solder the center conductor and contact. Pre-solder the contact. Shave the extra solder from the contact along the round of contact.

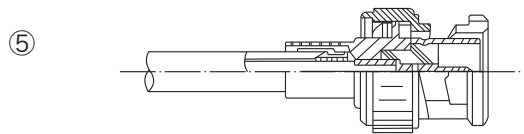

⑤ Insert above cable into the body. And insert the contact.

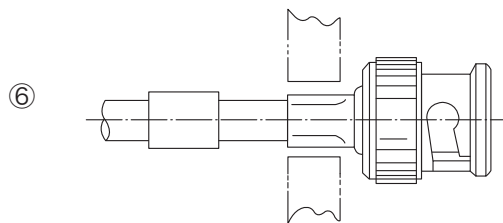

⑥ Crimping position is as fig.6.

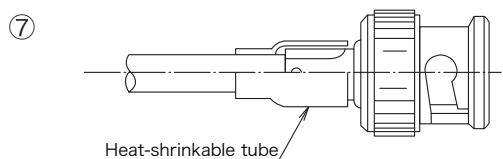

⑦ Cover the heat-shrinkable tube on the root of the connector body and heat up the tube.

Part Number	Crimp Tool
BNC75-P-2.5CW-CR10B-CF	CR-H-1105
BNC75-P-3CW-CR10B-CF	CR-H-1132

© Please acknowledge that the specification etc. of this catalog might change by the improvement etc. without notice. Moreover, the characteristic and the specification of the published product are the reference values. Please confirm the content with the latest delivery specifications when you use the product.

▶ Assembly Instruction (2)

Parts Configuration

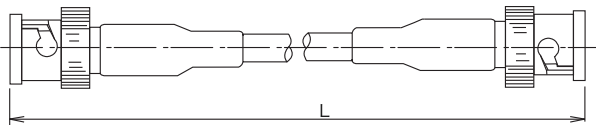
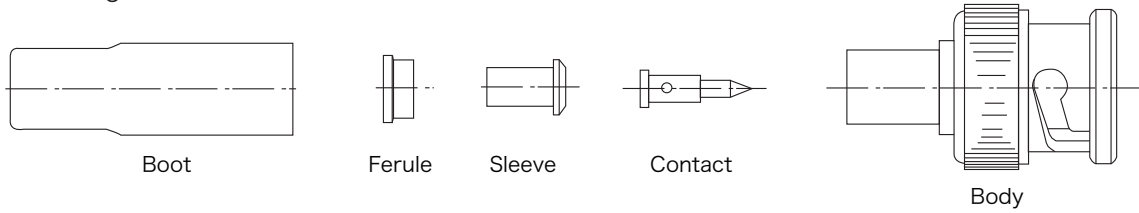

The cable length require for the double-ended cable assembly.
L-12mm

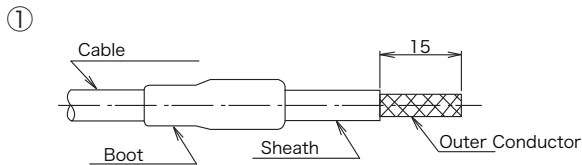

① Insert the boot into the cable and cut the cable as fig.1. Please be careful to not damage the outer conductor.

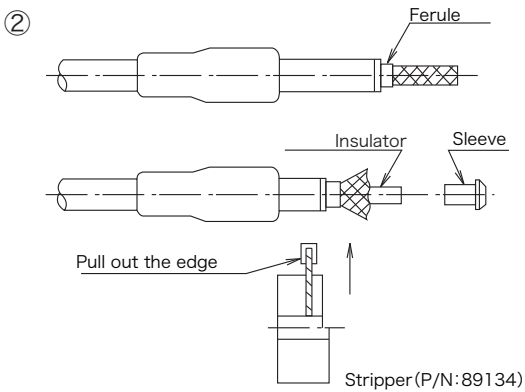

② Insert the ferule toward outer conductor. Spread the outer conductor and press in the sleeve with stripper (P/N:89134).

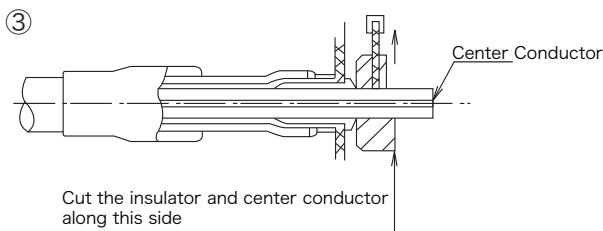

③ Cut the extra outer conductor and insulator from the stripper along the surface as fig.3.

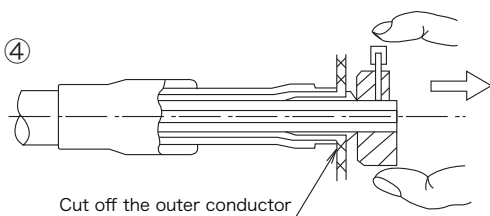

④ Push the edge of the stripper and rotate. Separate the insulator toward the arrow. Cut the outer conductor along the surface of sleeve.

© Please acknowledge that the specification etc. of this catalog might change by the improvement etc. without notice. Moreover, the characteristic and the specification of the published product are the reference values. Please confirm the content with the latest delivery specifications when you use the product.

▶ Assembly Instruction (2)

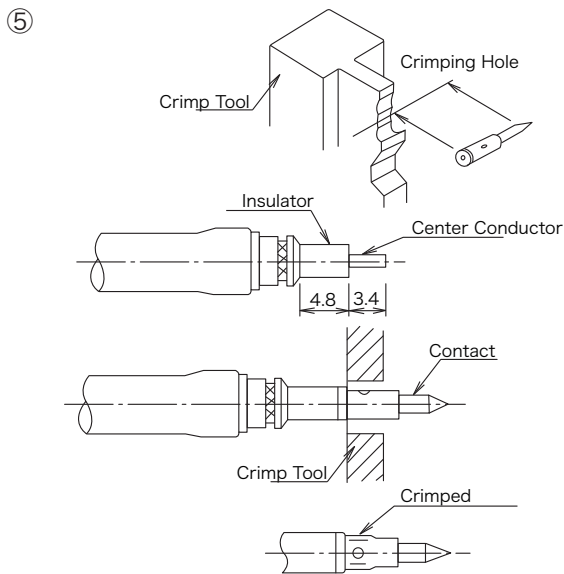

⑤ Pinch the contact in the crimping hole(center hole) and insert the center conductor of the cable. Crimp the contact (match the side hole of contact with the curve of crimping hole of tool.)

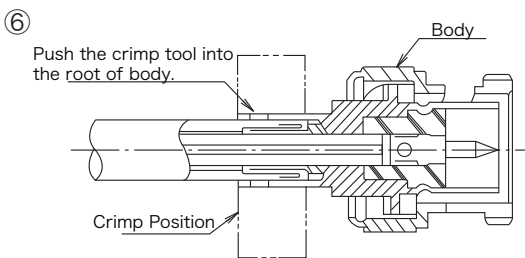

⑥ Insert the above contact into the body until the top of the contact is same level of the top of insulator. Please do not rotate the body and cable before crimping. Crimp the root of the body as fig.6.

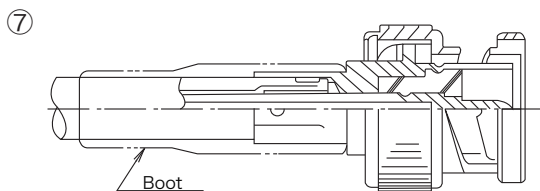

⑦ Cover the boot on the body.

▶ Assembly Instruction (3)

Parts Configuration

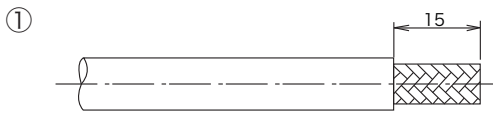
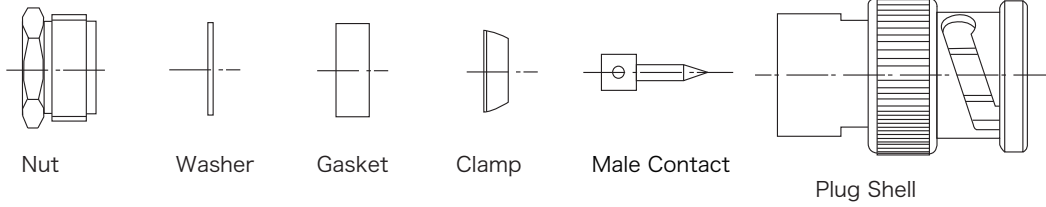

① Cut the cable as fig.1
Please be careful to not damage the outer conductor.

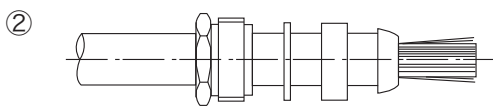

② Insert the nut, washer, gasket and clamp as fig.2. The clamp is held on the sheath and pick the outer conductor.

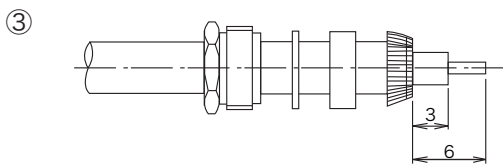

③ Cut the insulator and center conductor.
Turn down the outer conductor to the clamp and cut the outer conductor along the clamp. Cut the insulator and center conductor as fig.3.
Please be careful to not damage the center conductor.

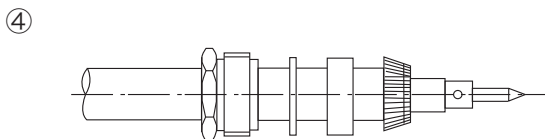

④ Solder up the contact to the center conductor.
Please be careful to not be swelled up the solder.
Please be careful to not gap between contact and insulator.
Please be careful to not deform the insulator by soldering.

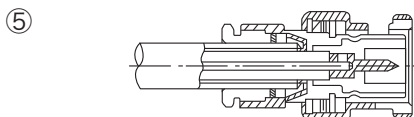

⑤ Insert the above contact into the body and screw up the nut.
Please screw up the nut by wrench.

© Please acknowledge that the specification etc. of this catalog might change by the improvement etc. without notice.
Moreover, the characteristic and the specification of the published product are the reference values.
Please confirm the content with the latest delivery specifications when you use the product.

▶ Assembly Instruction (4)

Parts Configuration

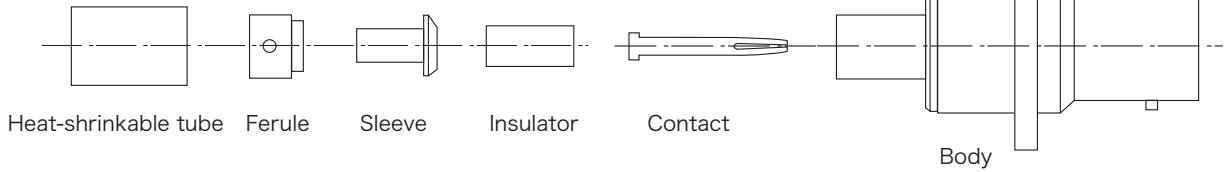

①

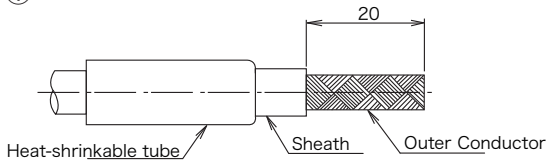

① Insert the heat-shrinkable tube into the cable and cut the cable as fig.1.

②

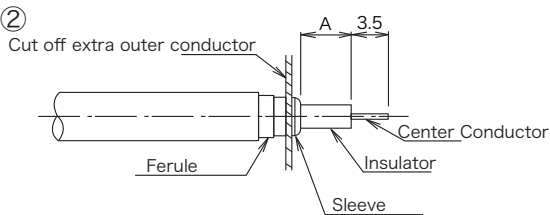

② Insert the ferule on the outer conductor. Pick the outer conductor and spread the top of center conductor. Insert the insulator from the outer conductor. Cut the extra outer conductor along the sleeve. Cut the insulator in length A. Cut the center conductor after pre-soldering.

Part Number	A
BNC75-J-2.5C2W-CR10A-CF	7.2mm
BNC75-PJ-3CW-CR10B-CF	6.8mm

③

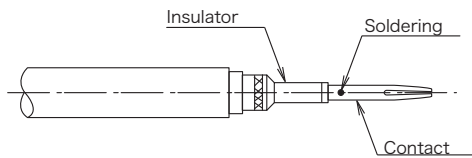

③ Insert the insulator and solder the contact.

④

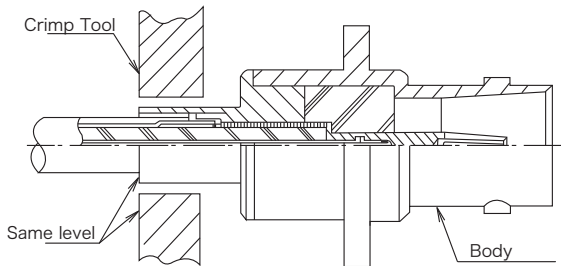

④ Insert the above contact into the body and crimp the body as fig.4.

Part Number	Crimp Tool
BNC75-J-2.5C2W-CR10A-CF	CR-H-1105
BNC75-PJ-3CW-CR10B-CF	CR-H-1132

⑤

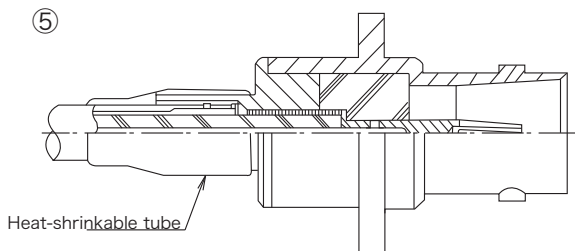

⑤ Cover the heat-shrinkable tube on the root of the connector body and heat up the tube.

© Please acknowledge that the specification etc. of this catalog might change by the improvement etc. without notice.
 Moreover, the characteristic and the specification of the published product are the reference values.
 Please confirm the content with the latest delivery specifications when you use the product.