

Three Phase Bridge + Thyristor

VRRM / VDRM 800 to 1600V
IFAV / ITAV 100Amp

Features

- Blocking voltage:800 to 1600V
- Three Phase Bridge and a Thyristor
- Isolated Module package

Applications

- Inverter for AC or DC motor control
- Current stabilized power supply
- Switching power supply
- UL E243882 approved

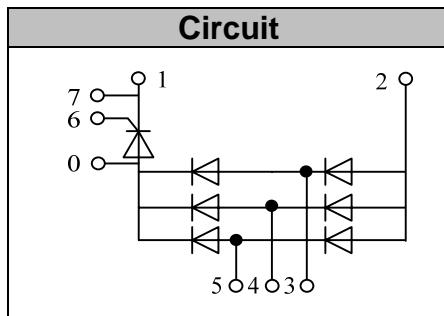

Module Type

TYPE	VRRM / VDRM	VRSM
MSDT100-08	800V	900V
MSDT100-12	1200V	1300V
MSDT100-16	1600V	1700V

◆Diode

Maximum Ratings

Symbol	Item	Conditions	Values	Units
ID	Output Current(D.C.)	Tc=100°C Three phase full wave	100	A
IFSM	Surge forward current	t=10mS Tvj =45°C	1200	A
i ² t	Circuit Fusing Consideration		7200	A ² s
Visol	Isolation Breakdown Voltage(R.M.S)	a.c.50HZ;r.m.s.;1min	3000	V
Tvj	Operating Junction Temperature		-40 to +150	°C
Tstg	Storage Temperature		-40 to +125	°C
Mt	Mounting Torque	To terminals(M5)	3±15%	Nm
Ms		To heatsink(M5)	3±15%	Nm
Weight		Module (Approximately)	210	g

Thermal Characteristics

Symbol	Item	Conditions	Values	Units
Rth(j-c)	Thermal Impedance, max.	Junction to Case(TOTAL)	0.18	°C/W
Rth(c-s)	Thermal Impedance, max.	Case to Heatsink	0.10	°C/W

Electrical Characteristics

Symbol	Item	Conditions	Values	Units
VFM	Forward Voltage Drop, max.	T=25°C IF =100A	1.35	V
I _{RRM}	Repetitive Peak Reverse Current, max.	Tvj =25°C VRD=VRRM Tvj =150°C VRD=VRRM	≤0.5 ≤6	mA mA

◆Thyristor

Maximum Ratings

Symbol	Item	Conditions	Values	Units
I_{TAV}	Average On-State Current	$T_c=92^{\circ}\text{C}$, Single Phase half wave 180° conduction	100	A
I_{TSM}	Surge On-State Current	$T_{VJ}=45^{\circ}\text{C}$ $t=10\text{ms}$ (50Hz), sine $V_R=0$	1200	A
i^2t	Circuit Fusing Consideration		7200	A^2s
Visol	Isolation Breakdown Voltage(R.M.S)	a.c.50HZ;r.m.s.;1 min	3000	V
T_{vj}	Operating Junction Temperature		-40 to +125	$^{\circ}\text{C}$
T_{stg}	Storage Temperature		-40 to +125	$^{\circ}\text{C}$
M_t	Mounting Torque	To terminals(M5)	3±15%	Nm
M_s		To heatsink(M5)	3±15%	Nm
di/dt	Critical Rate of Rise of On-State Current	$T_{VJ}=T_{VJM}$, $V_D=1/2V_{DRM}$, $I_G=100\text{mA}$ $d_i/d_t=0.1\text{A}/\mu\text{s}$	150	$\text{A}/\mu\text{s}$
dv/dt	Critical Rate of Rise of Off-State Voltage, min.	$T_J=T_{VJM}$, $V_D=2/3V_{DRM}$, linear voltage rise	500	$\text{V}/\mu\text{s}$

Electrical and Thermal Characteristics

Symbol	Item	Conditions	Values			Units
			Min.	Typ.	Max.	
V_{TM}	Peak On-State Voltage, max.	$T=25^{\circ}\text{C}$ $I_T=300\text{A}$			1.70	V
I_{RRM}/I_{DRM}	Repetitive Peak Reverse Current, max. / Repetitive Peak Off-State Current, max.	$T_{VJ}=T_{VJM}$, $V_R=V_{RRM}$, $V_D=V_{DRM}$			20	mA
V_{TO}	Threshold voltage	$T_{VJ} = T_{VJM}$			0.9	V
r_T	Slope resistance				2	$\text{m}\Omega$
V_{GT}	Gate Trigger Voltage, max.	$T_{VJ}=25^{\circ}\text{C}$, $V_D=6\text{V}$			3	V
I_{GT}	Gate Trigger Current, max.	$T_{VJ}=25^{\circ}\text{C}$, $V_D=6\text{V}$			150	mA
V_{GD}	Max. required DC gate voltage	$T_{VJ}=125^{\circ}\text{C}$, $V_D=2/3V_{DRM}$			0.25	V
I_{GD}	Max. required DC gate current	$T_{VJ}=125^{\circ}\text{C}$, $V_D=2/3V_{DRM}$			6	mA
I_L	Maximum latching current	$T_{VJ}=25^{\circ}\text{C}$, $R_G=33\Omega$	300	600		mA
I_H	Maximum holding current	$T_{VJ}=25^{\circ}\text{C}$, $V_D=6\text{V}$	150	250		mA
t_{gd}	Gate controlled delay time	$T_{VJ}=25^{\circ}\text{C}$, $I_G=1\text{A}$, $d_i/d_t=1\text{A}/\mu\text{s}$	1			μs
t_q	Circuit commutated turn-off time	$T_{VJ} = T_{VJM}$		100		μs
$R_{th(j-c)}$	Thermal Impedance, max.	Junction to Case			0.26	$^{\circ}\text{C}/\text{W}$
$R_{th(c-s)}$	Thermal Impedance, max.	Case to Heatsink			0.10	$^{\circ}\text{C}/\text{W}$

Performance Curves

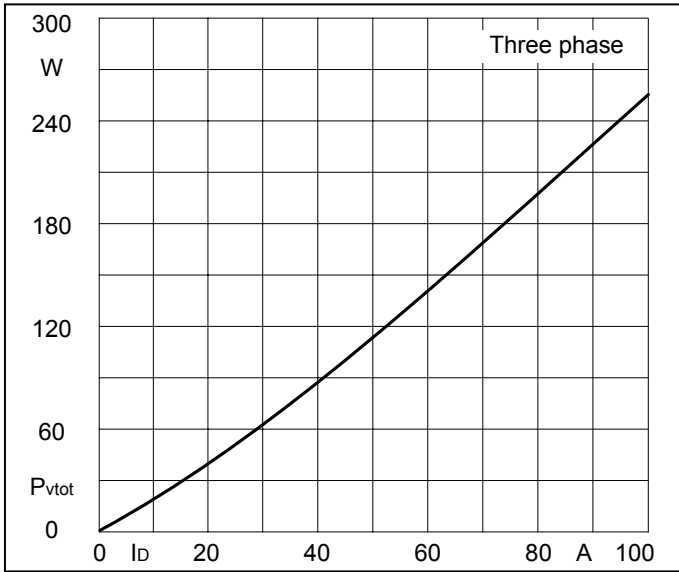

Fig1. Power dissipation

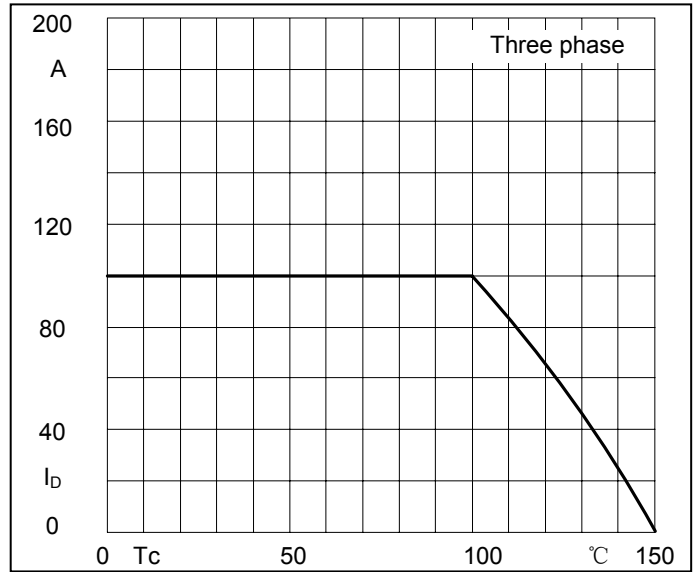

Fig2. Forward Current Derating Curve

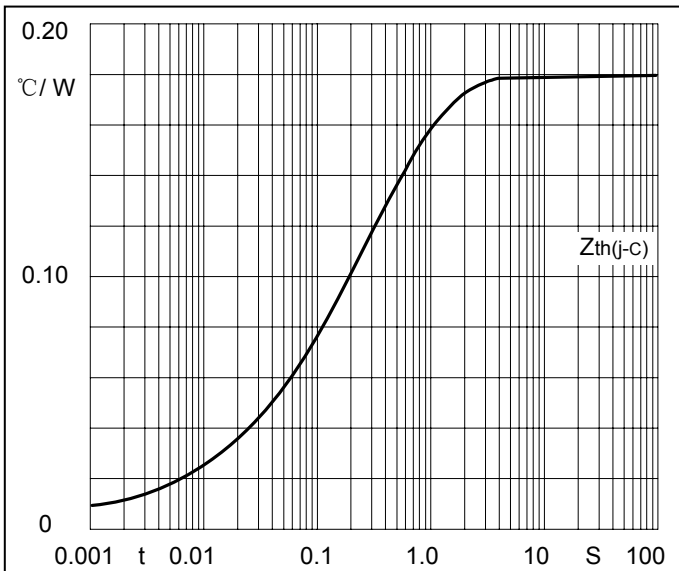

Fig3. Transient thermal impedance

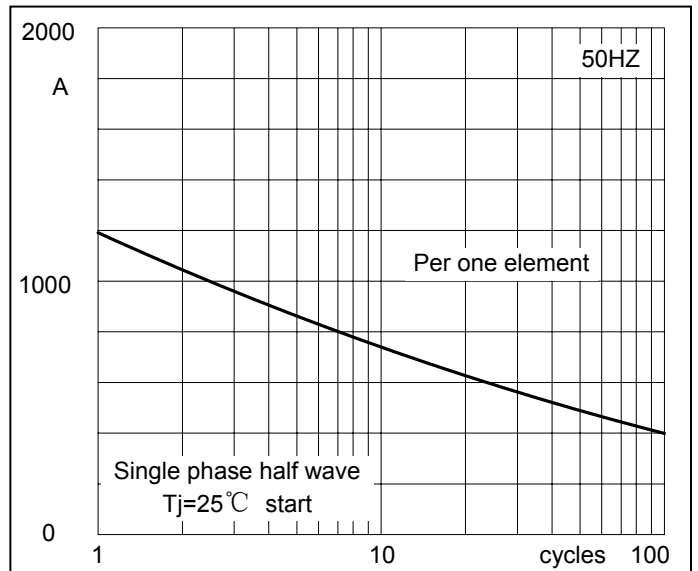

Fig4. Max Non-Repetitive Forward Surge Current

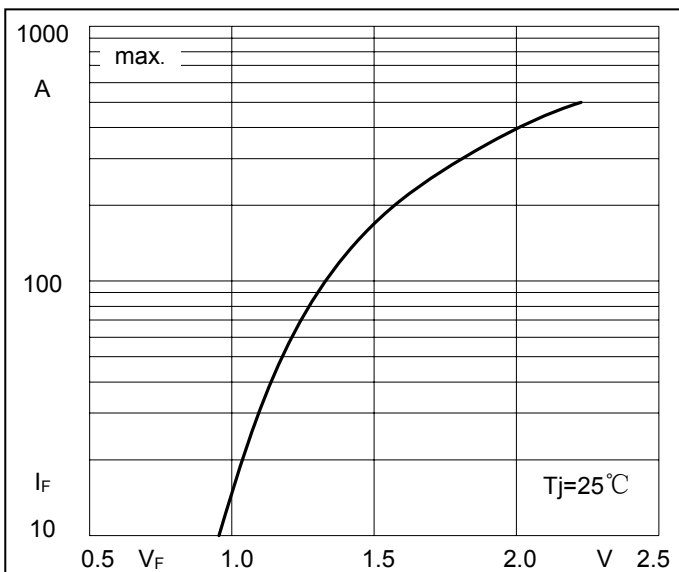

Fig5. Forward Characteristics

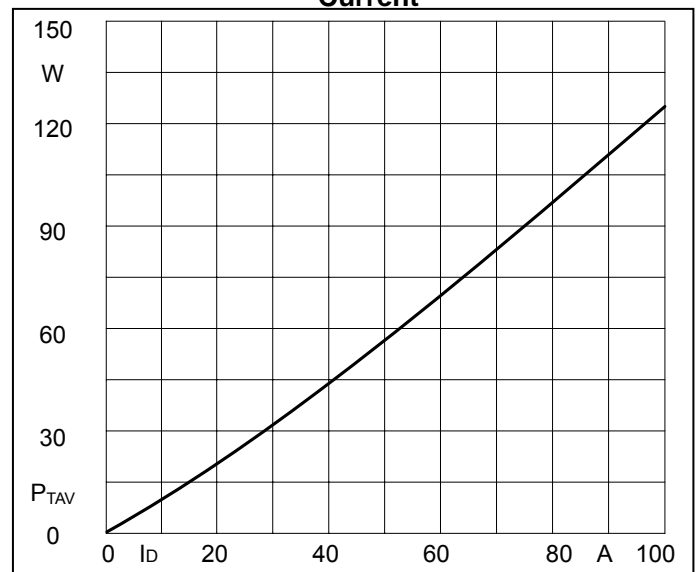

Fig6. SCR Power dissipation

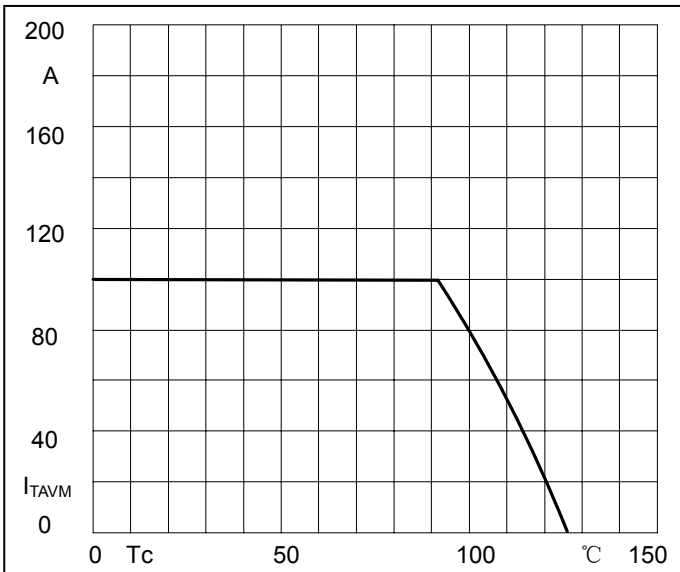

Fig7. SCR Forward Current Derating Curve

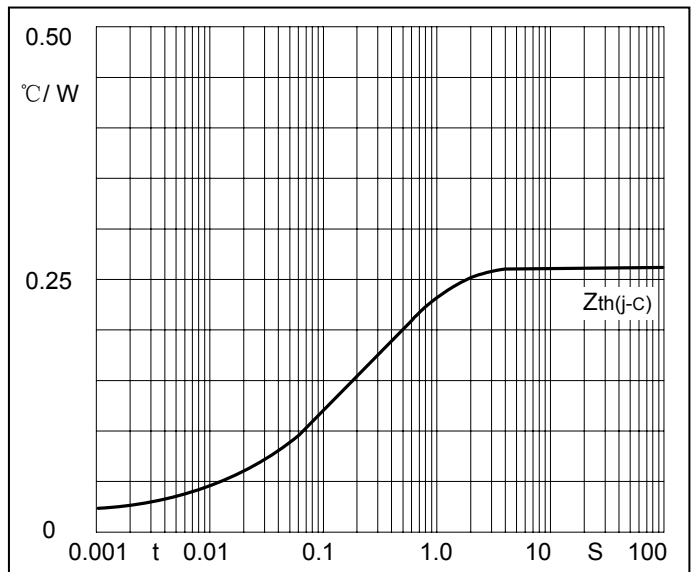

Fig8. SCR Transient thermal impedance

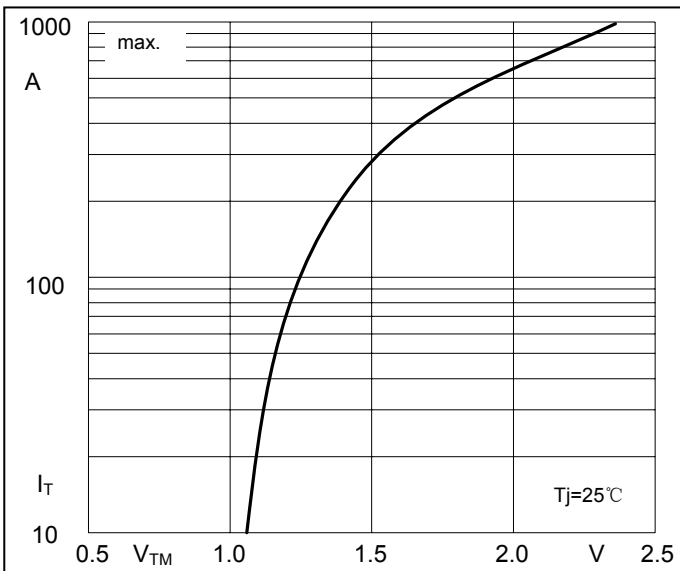

Fig9. SCR Forward Characteristics

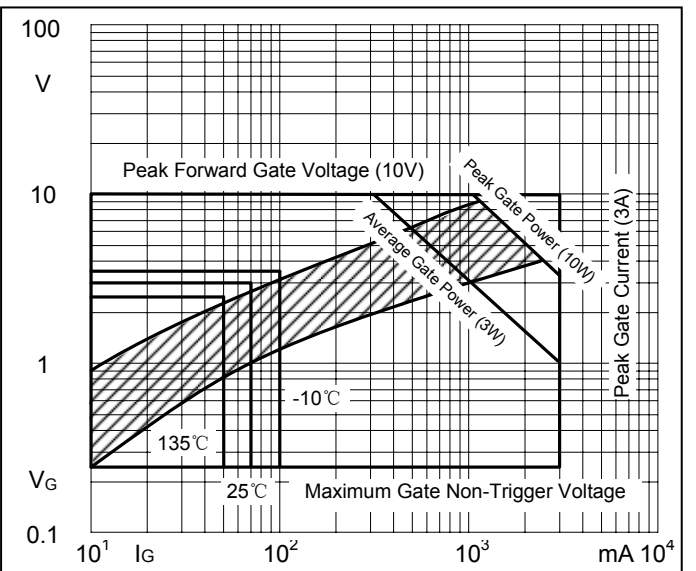

Fig10. Gate trigger Characteristics

Package Outline Information

