

DATA SHEET

E25/10/6

E cores and accessories

Supersedes data of September 2004

2008 Sep 01



FERROXCUBE
A YAGEO COMPANY

CORE SETS

Effective core parameters

SYMBOL	PARAMETER	VALUE	UNIT
$\Sigma(l/A)$	core factor (C1)	1.24	mm ⁻¹
V_e	effective volume	1930	mm ³
l_e	effective length	49.0	mm
A_e	effective area	39.5	mm ²
A_{min}	minimum area	37.0	mm ²
m	mass of core half	≈ 4.8	g

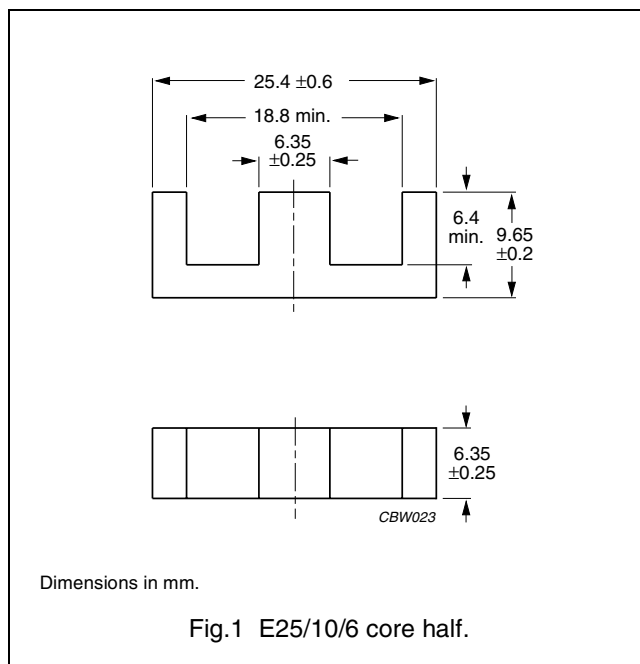

Core halves

A_L measured in combination with a non-gapped core half, clamping force for A_L measurements, 20 ± 10 N, unless otherwise stated.

GRADE	A_L (nH)	μ_e	TOTAL AIR GAP (μ m)	TYPE NUMBER
3C81	63 ± 5% ⁽¹⁾	≈ 62	≈ 1240	E25/10/6-3C81-E63
	100 ± 8%	≈ 99	≈ 660	E25/10/6-3C81-A100
	160 ± 8%	≈ 158	≈ 360	E25/10/6-3C81-A160
	250 ± 15%	≈ 247	≈ 210	E25/10/6-3C81-A250
	315 ± 15%	≈ 311	≈ 160	E25/10/6-3C81-A315
	2340 ± 25%	≈ 2310	≈ 0	E25/10/6-3C81
3C90	63 ± 5% ⁽¹⁾	≈ 62	≈ 1240	E25/10/6-3C90-E63
	100 ± 8%	≈ 99	≈ 660	E25/10/6-3C90-A100
	160 ± 8%	≈ 158	≈ 360	E25/10/6-3C90-A160
	250 ± 15%	≈ 247	≈ 210	E25/10/6-3C90-A250
	315 ± 15%	≈ 311	≈ 150	E25/10/6-3C90-A315
	1600 ± 25%	≈ 1580	≈ 0	E25/10/6-3C90
3C91 des	2340 ± 25%	≈ 2310	≈ 0	E25/10/6-3C91
3C92 des	1320 ± 25%	≈ 1300	≈ 0	E25/10/6-3C92
3C94	1600 ± 25%	≈ 1580	≈ 0	E25/10/6-3C94
3C96 des	1470 ± 25%	≈ 1450	≈ 0	E25/10/6-3C96

GRADE	A _L (nH)	μ _e	TOTAL AIR GAP (μm)	TYPE NUMBER
3F3	63 ±5% ⁽¹⁾	≈ 62	≈ 1240	E25/10/6-3F3-E63
	100 ±8%	≈ 99	≈ 660	E25/10/6-3F3-A100
	160 ±8%	≈158	≈ 360	E25/10/6-3F3-A160
	250 ±15%	≈ 247	≈ 210	E25/10/6-3F3-A250
	315 ±15%	≈ 311	≈ 150	E25/10/6-3F3-A315
	1470 ±25%	≈ 1450	≈ 0	E25/10/6-3F3
3F35 <small>des</small>	1150 ±25%	≈ 1140	≈ 0	E25/10/6-3F35

Note

1. Measured in combination with an equal gapped core half, clamping force for A_L measurements, 20 ±10 N.

Core halves of high permeability grades

Clamping force for A_L measurements, 20 ±10 N.

GRADE	A _L (nH)	μ _e	AIR GAP (μm)	TYPE NUMBER
3E27	3200 ±25%	≈ 3160	≈ 0	E25/10/6-3E27

Properties of core sets under power conditions

GRADE	B (mT) at	CORE LOSS (W) at			
	H = 250 A/m; f = 25 kHz; T = 100 °C	f = 25 kHz; B = 200 mT; T = 100 °C	f = 100 kHz; B = 100 mT; T = 100 °C	f = 100 kHz; B = 200 mT; T = 100 °C	f = 400 kHz; B = 50 mT; T = 100 °C
3C81	≥320	≤ 0.4	–	–	–
3C90	≥330	≤ 0.2	≤ 0.22	–	–
3C91	≥320	–	≤0.13 ⁽¹⁾	≤ 0.8 ⁽¹⁾	–
3C92	≥370	–	≤ 0.17	≤ 1.0	–
3C94	≥330	–	≤ 0.17	≤ 1.0	–
3C96	≥340	–	≤ 0.13	≤ 0.8	–
3F3	≥320	–	≤ 0.22	–	≤ 0.38
3F35	≥300	–	–	–	–

Properties of core sets under power conditions (continued)

GRADE	B (mT) at	CORE LOSS (W) at			
	H = 250 A/m; f = 25 kHz; T = 100 °C	f = 500 kHz; B = 50 mT; T = 100 °C	f = 500 kHz; B = 100 mT; T = 100 °C	f = 1 MHz; B = 30 mT; T = 100 °C	f = 3 MHz; B = 10 mT; T = 100 °C
3C96	≥340	≤ 0.7	–	–	–
3F3	≥320	–	–	–	–
3F35	≥300	≤ 0.26	≤ 2.0	–	–

Note

1. Measured at 60 °C.

COIL FORMERS

General data for E25/10/6 coil former without pins

PARAMETER	SPECIFICATION
Coil former material	polyamide (PA6.6), glass reinforced, flame retardant in accordance with "UL 94V-2"
Maximum operating temperature	105 °C, "IEC 60085", class A

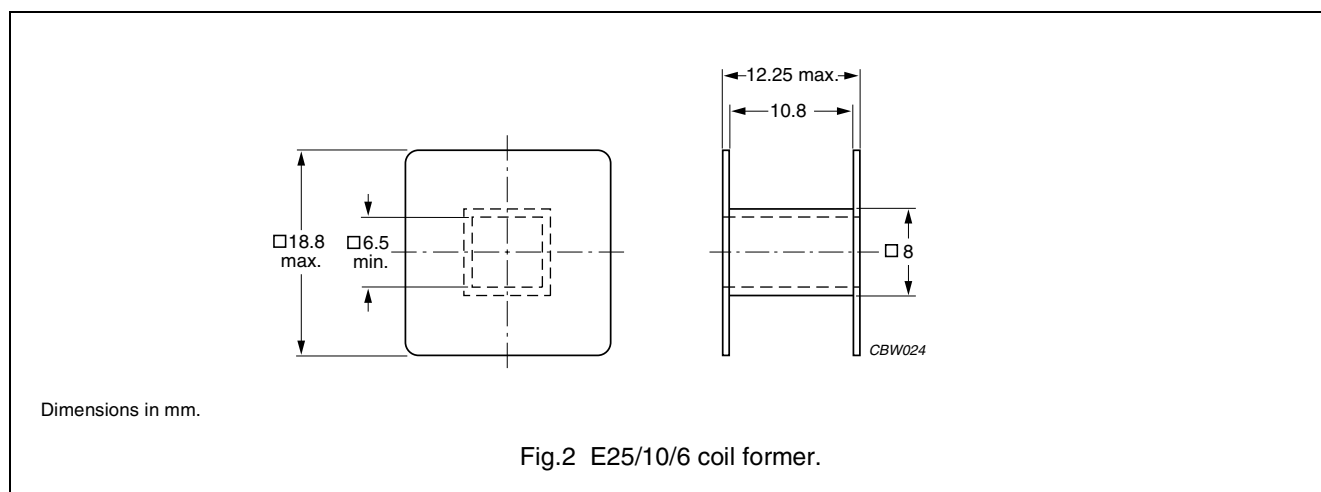

Winding data and area product for E25/10/6 coil former without pins

NUMBER OF SECTIONS	MINIMUM WINDING AREA (mm ²)	NOMINAL WINDING WIDTH (mm)	AVERAGE LENGTH OF TURN (mm)	AREA PRODUCT Ae x Aw (mm ⁴)	TYPE NUMBER
1	56.2	10.8	49.1	2220	CP-E25/10/6-1S

General data for 10-pins E25/10/6 coil former

PARAMETER	SPECIFICATION
Coil former material	polyamide (PA), glass reinforced, flame retardant in accordance with "UL 94-HB"; UL file number E41938(M)
Pin material	copper-zinc alloy (CuZn), tin (Sn) plated
Maximum operating temperature	130 °C, "IEC 60085", class B
Resistance to soldering heat	"IEC 60068-2-20", Part 2, Test Tb, method 1B: 350 °C, 3.5 s
Solderability	"IEC 60068-2-20", Part 2, Test Ta, method 1: 235 °C, 2 s

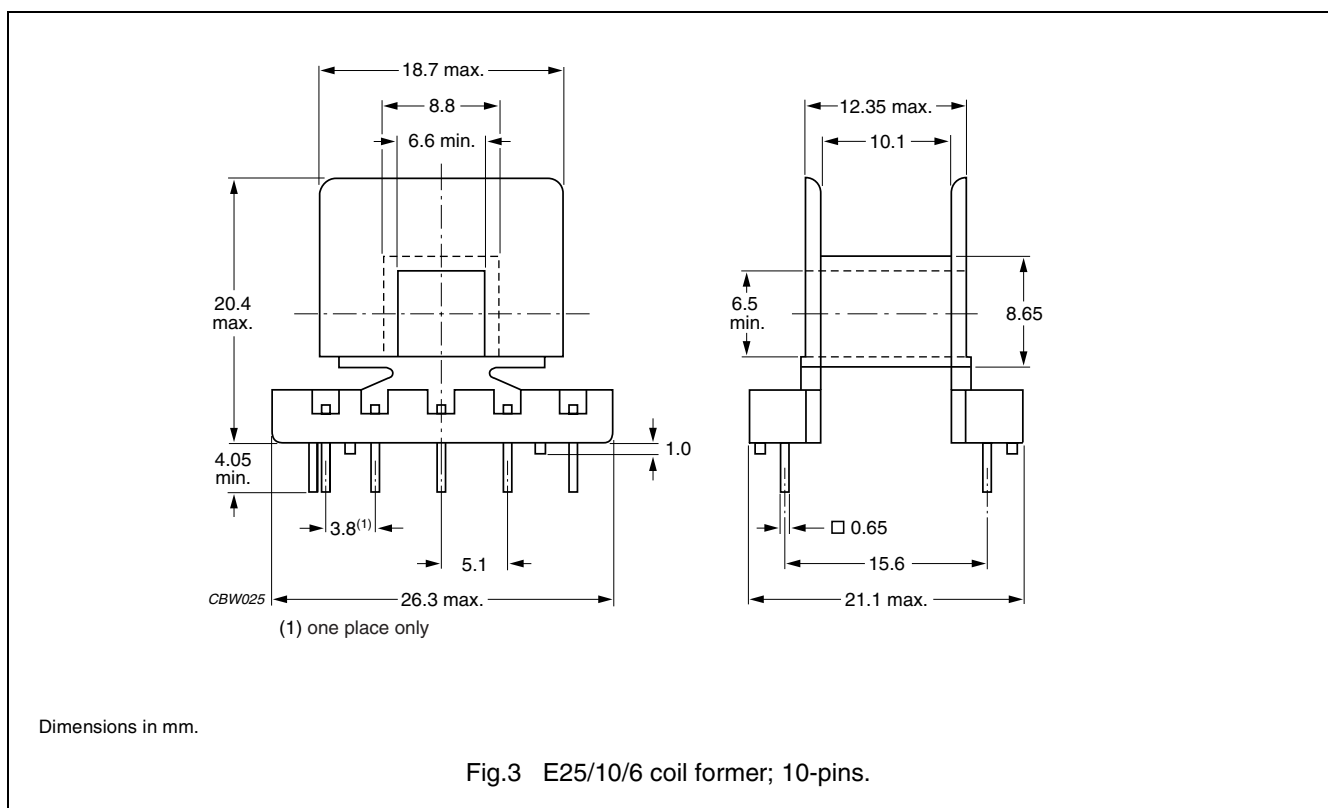

Winding data and area product for 10-pins E25/10/6 coil former

NUMBER OF SECTIONS	MINIMUM WINDING AREA (mm ²)	NOMINAL WINDING WIDTH (mm)	AVERAGE LENGTH OF TURN (mm)	AREA PRODUCT Ae x Aw (mm ⁴)	TYPE NUMBER
1	47.4	10.1	53.1	1870	CPH-E25/10/6-1S-10P-Z

MOUNTING PARTS

General data for mounting parts

ITEM	REMARKS	FIGURE	TYPE NUMBER
Clamp	stainless steel (CrNi); clamping force ≈ 30 N	3	CLM-E25/10/6

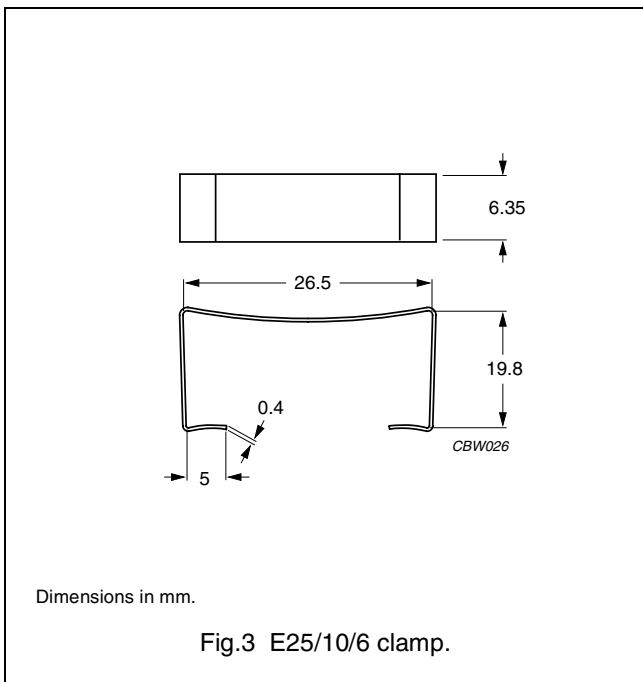



DATA SHEET STATUS DEFINITIONS

DATA SHEET STATUS	PRODUCT STATUS	DEFINITIONS
Preliminary specification	Development	This data sheet contains preliminary data. Ferroxcube reserves the right to make changes at any time without notice in order to improve design and supply the best possible product.
Product specification	Production	This data sheet contains final specifications. Ferroxcube reserves the right to make changes at any time without notice in order to improve design and supply the best possible product.

DISCLAIMER

Life support applications — These products are not designed for use in life support appliances, devices, or systems where malfunction of these products can reasonably be expected to result in personal injury. Ferroxcube customers using or selling these products for use in such applications do so at their own risk and agree to fully indemnify Ferroxcube for any damages resulting from such application.

PRODUCT STATUS DEFINITIONS

STATUS	INDICATION	DEFINITION
Prototype		These are products that have been made as development samples for the purposes of technical evaluation only. The data for these types is provisional and is subject to change.
Design-in		These products are recommended for new designs.
Preferred		These products are recommended for use in current designs and are available via our sales channels.
Support		These products are not recommended for new designs and may not be available through all of our sales channels. Customers are advised to check for availability.