

Features

- Seven Darlington pairs per package
- Output current 500 mA per driver (600 mA peak)
- Output voltage 50 V
- Integrated suppression diodes for inductive loads
- Outputs can be paralleled for higher current
- TTL/CMOS/PMOS/DTL compatible inputs
- Inputs pinned opposite outputs to simplify layout

Description

The ULN2001, ULN2002, ULN2003 and ULN2004 are high voltage, high current Darlington arrays each containing seven open collector Darlington pairs with common emitters. Each channel rated at 500 mA and can withstand peak currents of 600 mA. Suppression diodes are included for inductive load driving and the inputs are pinned opposite the outputs to simplify board layout.

The versions interface to all common logic families:

- ULN2001 (general purpose, DTL, TTL, PMOS, CMOS)
- ULN2002 (14 - 25 V PMOS)
- ULN2003 (5 V TTL, CMOS)
- ULN2004 (6 - 15 V CMOS, PMOS)

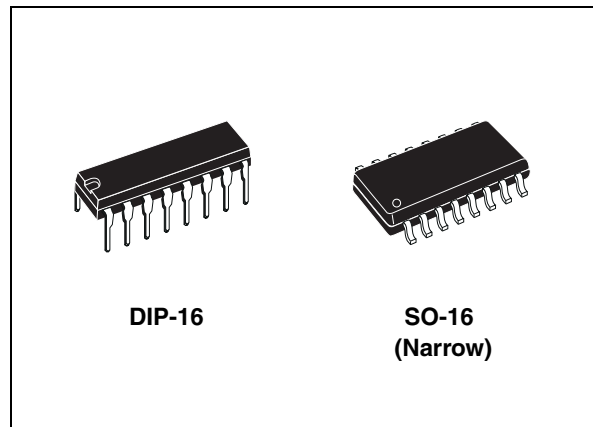

These versatile devices are useful for driving a wide range of loads including solenoids, relays DC motors, LED displays filament lamps, thermal printheads and high power buffers.

The ULN2001A/2002A/2003A and 2004A are supplied in 16 pin plastic DIP packages with a copper leadframe to reduce thermal resistance. They are available also in small outline package (SO-16) as ULN2001D1/2002D1/2003D1/2004D1

Table 1. Device summary

Order codes	
ULN2001A	ULN2001D1013TR
ULN2002A	ULN2002D1013TR
ULN2003A	ULN2003D1013TR
ULN2004A	ULN2004D1013TR

Contents

1	Diagram	3
2	Pin configuration	4
3	Maximum ratings	5
4	Electrical characteristics	6
5	Test circuits	7
6	Typical performance characteristics	9
7	Package mechanical data	11
8	Order codes	14
9	Revision history	15

1 Diagram

Figure 1. Schematic diagram

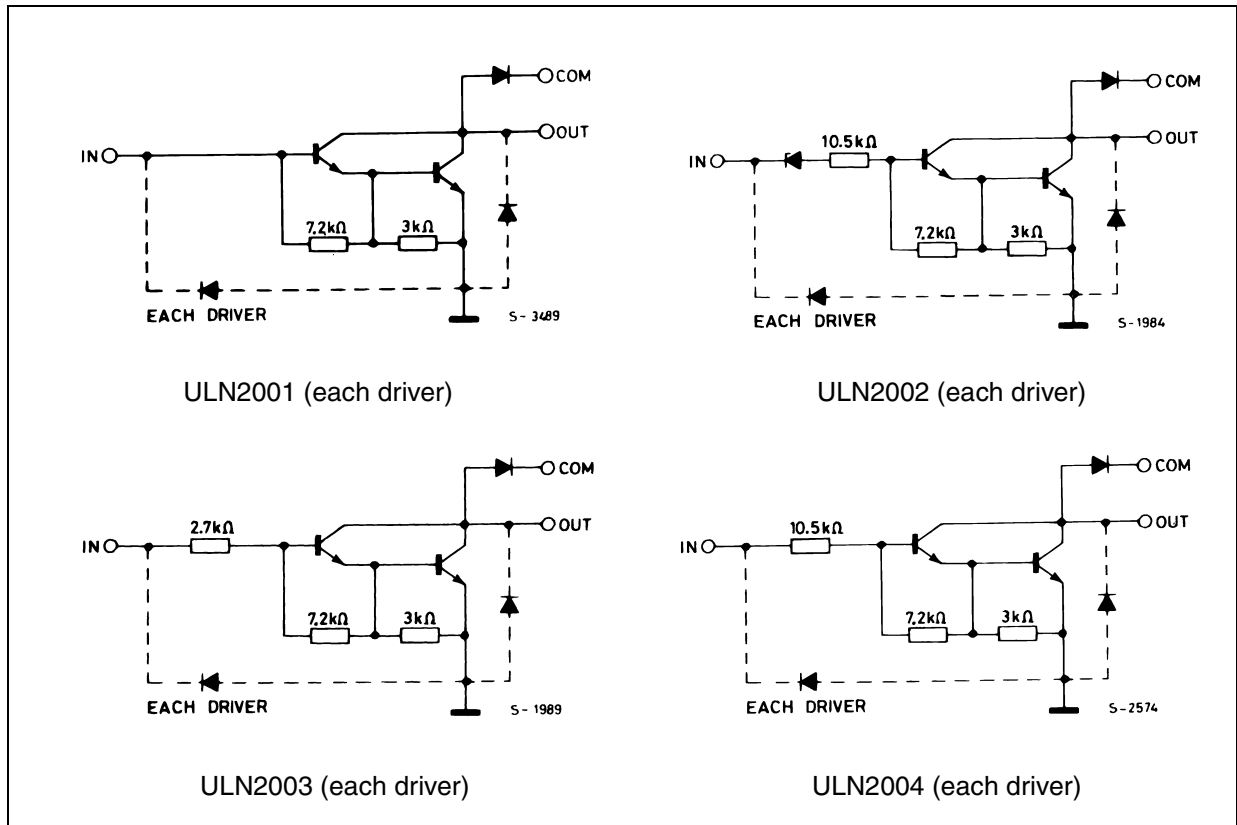

2 Pin configuration

Figure 2. Pin connections (top view)

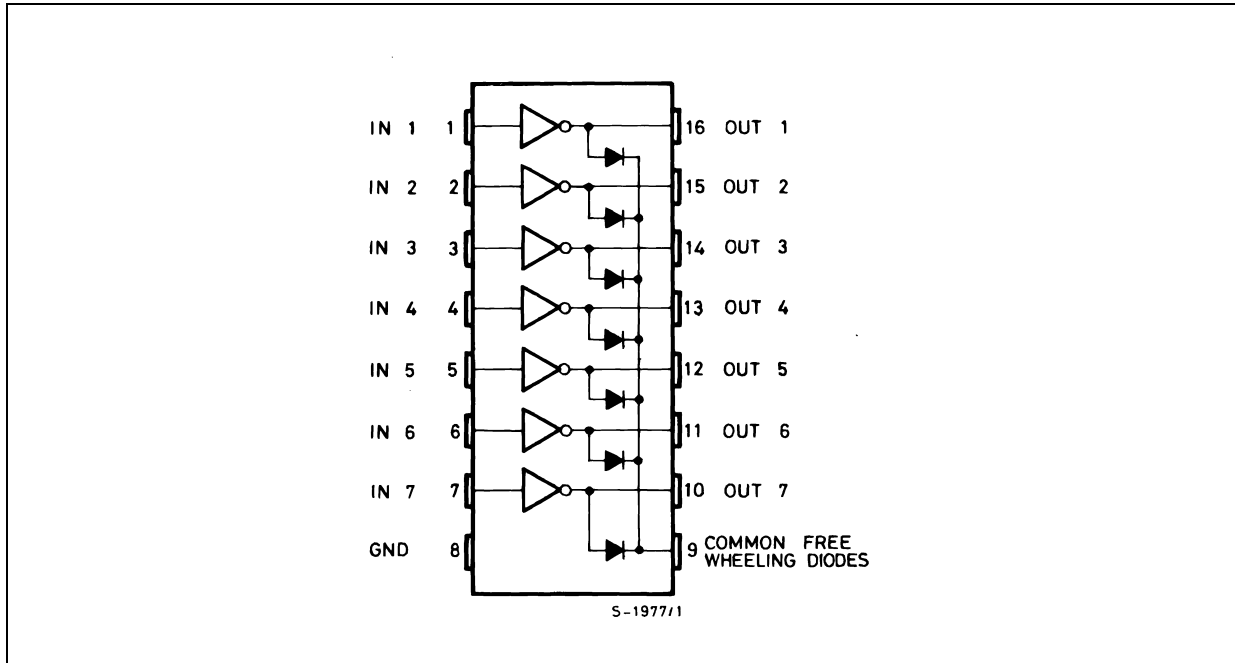

3 Maximum ratings

Table 2. Absolute maximum ratings

Symbol	Parameter	Value	Unit
V_O	Output voltage	50	V
V_I	Input voltage (for ULN2002A/D - 2003A/D - 2004A/D)	30	V
I_C	Continuous collector current	500	mA
I_B	Continuous base current	25	mA
T_A	Operating ambient temperature range	- 40 to 85	°C
T_{STG}	Storage temperature range	- 55 to 150	°C
T_J	Junction temperature	150	°C

Table 3. Thermal data

Symbol	Parameter	DIP-16	SO-16	Unit
R_{thJA}	Thermal resistance junction-ambient, Max.	70	120	°C/W

4 Electrical characteristics

$T_A = 25\text{ }^\circ\text{C}$ unless otherwise specified.

Table 4. Electrical characteristics

Symbol	Parameter	Test condition	Min.	Typ.	Max.	Unit
I_{CEX}	Output leakage current	$V_{CE} = 50\text{ V}$, (<i>Figure 3.</i>)			50	μA
		$T_A = 85^\circ\text{C}$, $V_{CE} = 50\text{ V}$ (<i>Figure 3.</i>)			100	
		$T_A = 85^\circ\text{C}$ for ULN2002, $V_{CE} = 50\text{ V}$, $V_I = 6\text{ V}$ (<i>Figure 4.</i>)			500	
		$T_A = 85^\circ\text{C}$ for ULN2002, $V_{CE} = 50\text{ V}$, $V_I = 1\text{ V}$ (<i>Figure 4.</i>)			500	
$V_{CE(SAT)}$	Collector-emitter saturation voltage (<i>Figure 5.</i>)	$I_C = 100\text{ mA}$, $I_B = 250\text{ }\mu\text{A}$		0.9	1.1	V
		$I_C = 200\text{ mA}$, $I_B = 350\text{ }\mu\text{A}$		1.1	1.3	
		$I_C = 350\text{ mA}$, $I_B = 500\text{ }\mu\text{A}$		1.3	1.6	
$I_{I(ON)}$	Input current (<i>Figure 6.</i>)	for ULN2002, $V_I = 17\text{ V}$		0.82	1.25	mA
		for ULN2003, $V_I = 3.85\text{ V}$		0.93	1.35	
		for ULN2004, $V_I = 5\text{ V}$		0.35	0.5	
		$V_I = 12\text{ V}$		1	1.45	
$I_{I(OFF)}$	Input current (<i>Figure 7.</i>)	$T_A = 85^\circ\text{C}$, $I_C = 500\text{ }\mu\text{A}$	50	65		μA
$V_{I(ON)}$	Input voltage (<i>Figure 8.</i>)	$V_{CE} = 2\text{ V}$, for ULN2002			13	V
		$I_C = 300\text{ mA}$			2.4	
		for ULN2003			2.7	
		$I_C = 200\text{ mA}$			3	
		$I_C = 250\text{ mA}$			5	
		for ULN2004			6	
		$I_C = 125\text{ mA}$			7	
		$I_C = 200\text{ mA}$			8	
h_{FE}	DC Forward current gain (<i>Figure 5.</i>)	for ULN2001, $V_{CE} = 2\text{ V}$, $I_C = 350\text{ mA}$	1000			
C_I	Input capacitance			15	25	pF
t_{PLH}	Turn-on delay time	$0.5\text{ }V_I$ to $0.5\text{ }V_O$		0.25	1	μs
t_{PHL}	Turn-off delay time	$0.5\text{ }V_I$ to $0.5\text{ }V_O$		0.25	1	μs
I_R	Clamp diode leakage current (<i>Figure 9.</i>)	$V_R = 50\text{ V}$			50	μA
		$T_A = 85^\circ\text{C}$, $V_R = 50\text{ V}$			100	
V_F	Clamp diode forward voltage (<i>Figure 10.</i>)	$I_F = 350\text{ mA}$		1.7	2	V

5 Test circuits

Figure 3. Output leakage current

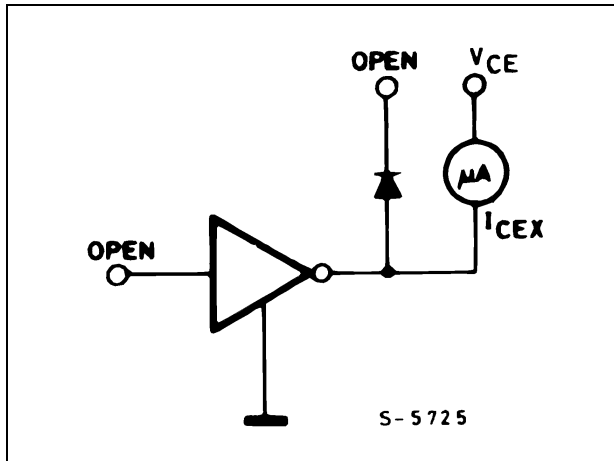

Figure 4. Output leakage current (for ULN2002 only)

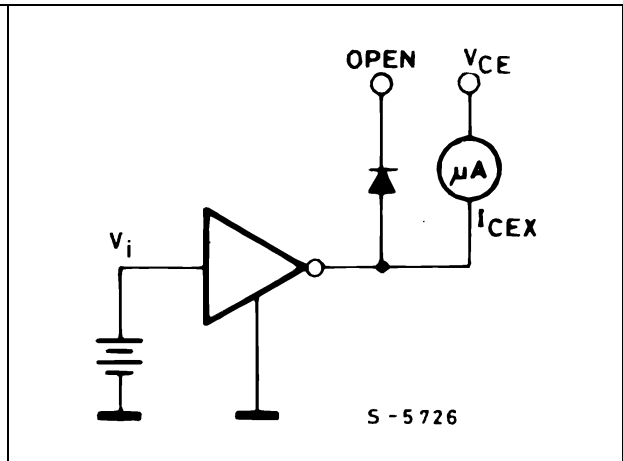

Figure 5. Collector-emitter saturation voltage Figure 6. Input current (ON)

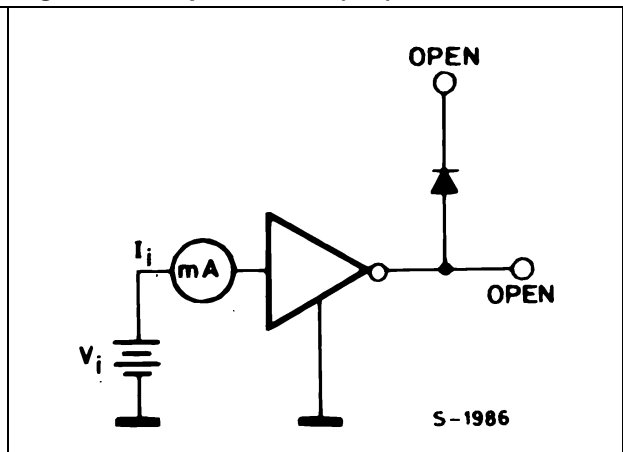
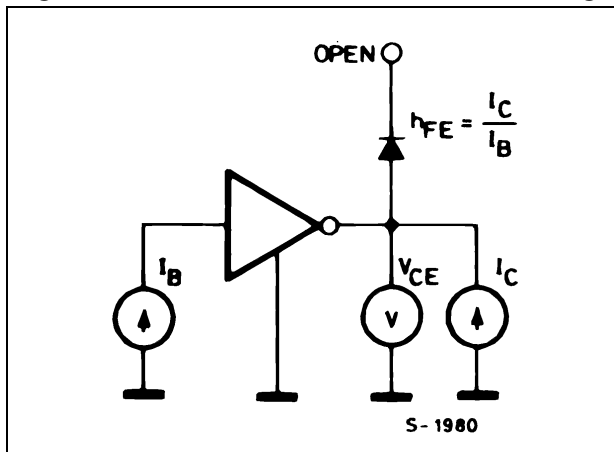

Figure 7. Input current (OFF)

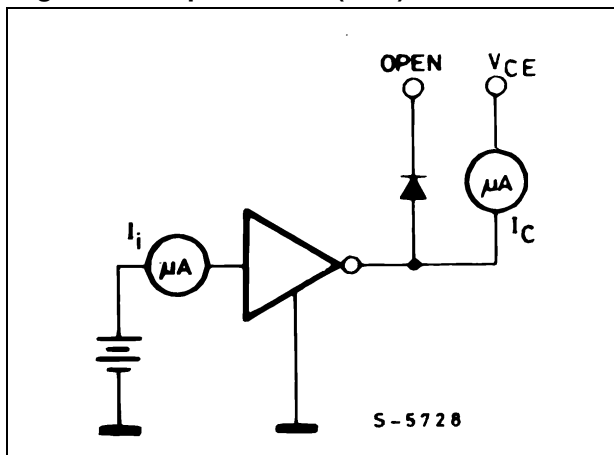

Figure 8. Input voltage

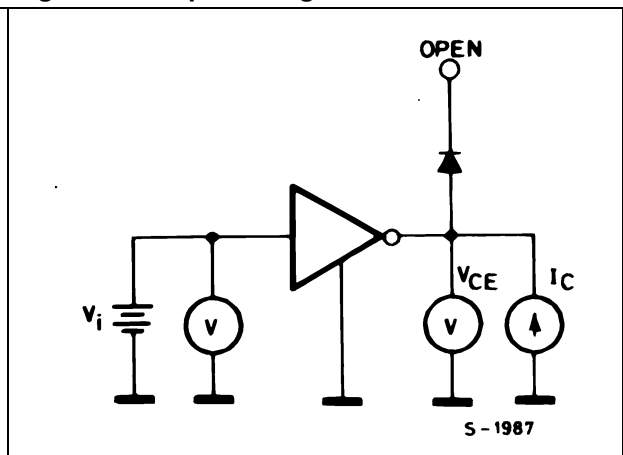

Figure 9. Clamp diode leakage current

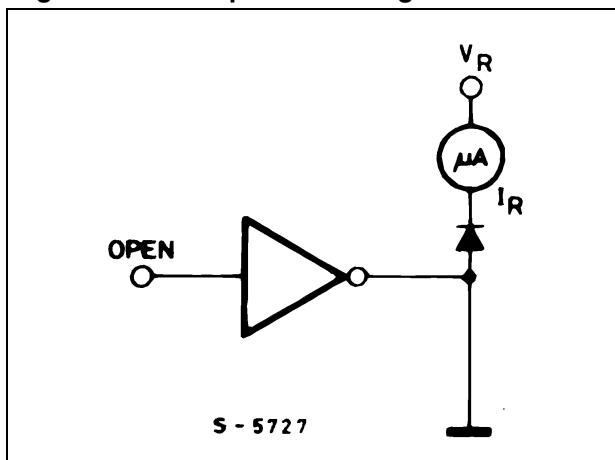
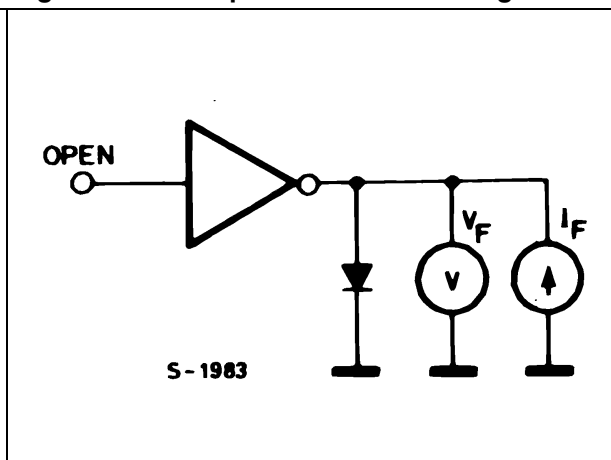

Figure 10. Clamp diode forward voltage



6 Typical performance characteristics

Figure 11. Collector current vs. saturation voltage ($T_J = 25^\circ\text{C}$)

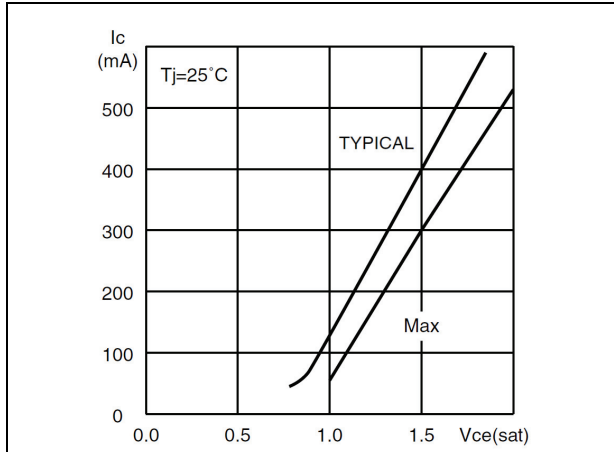

Figure 12. Collector current vs. saturation voltage

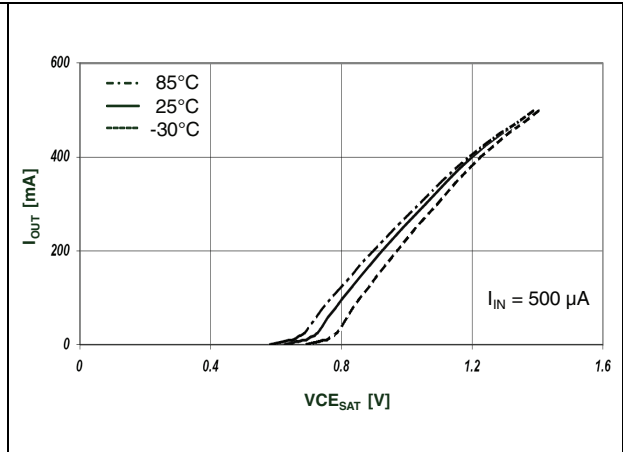

Figure 13. Input current vs. input voltage

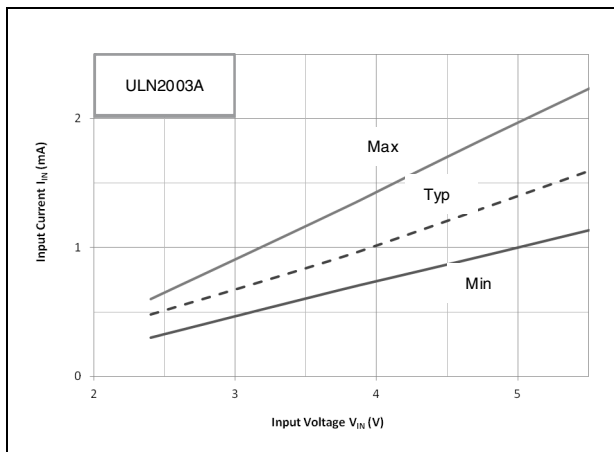

Figure 14. Input current vs. input voltage ($T_a = 25^\circ\text{C}$)

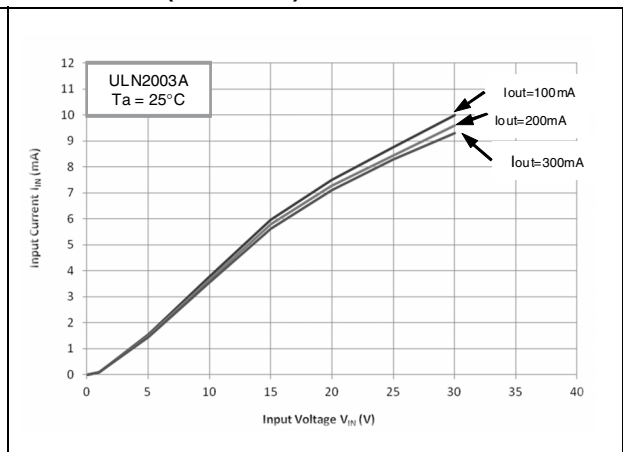

Figure 15. Collector current vs. input current

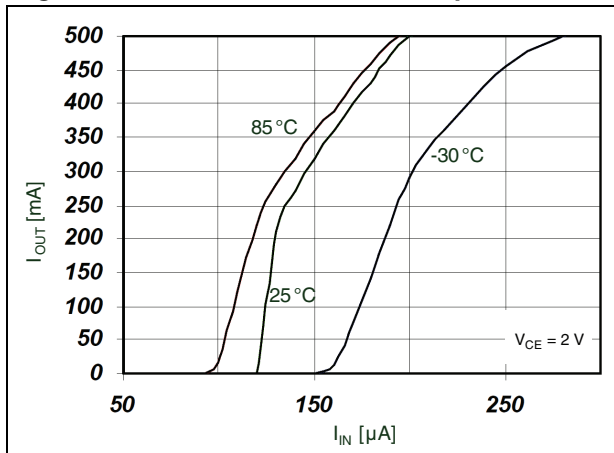

Figure 16. h_{FE} vs. output current

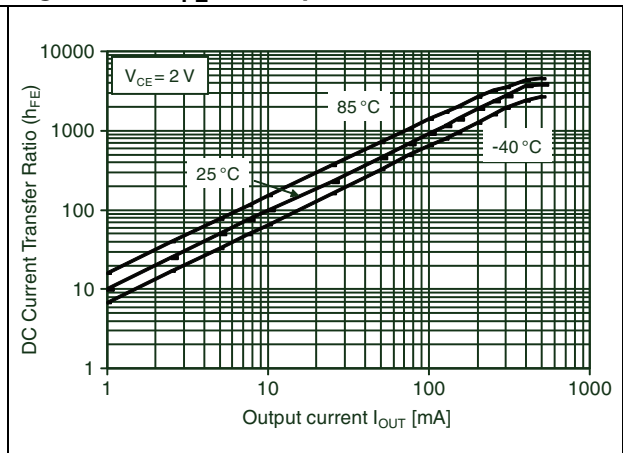

Figure 17. Peak collector current vs. duty cycle (DIP-16)

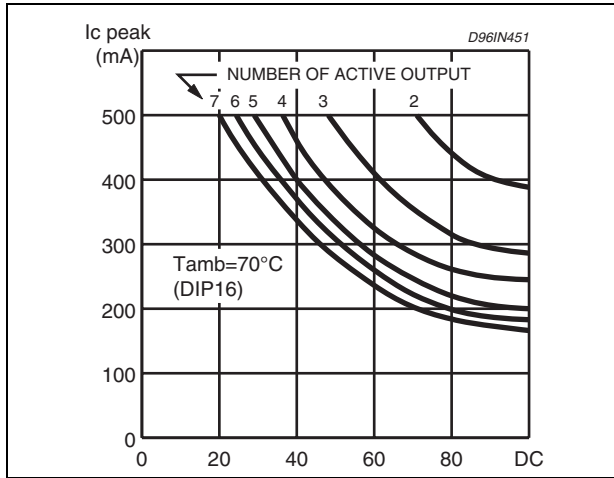
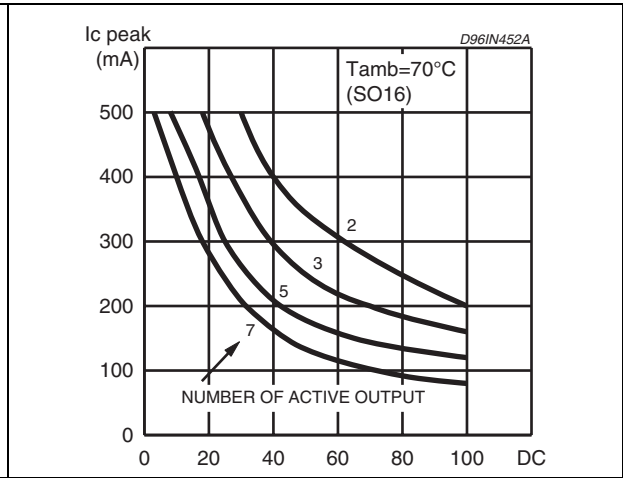

Figure 18. Peak collector current vs. duty cycle (SO-16)



7 Package mechanical data

In order to meet environmental requirements, ST offers these devices in different grades of ECOPACK® packages, depending on their level of environmental compliance. ECOPACK® specifications, grade definitions and product status are available at: www.st.com. ECOPACK® is an ST trademark.

Table 5. DIP-16L mechanical data

Dim.	mm.		
	Min.	Typ.	Max.
A			5.33
A1	0.38		
A2	2.92	3.30	4.95
b	0.36	0.46	0.56
b2	1.14	1.52	1.78
c	0.20	0.25	0.36
D	18067	19.18	19.69
E	7.62	7.87	8.26
E1	6.10	6.35	7.11
e		2.54	
e1		17.78	
eA		7.62	
eB			10.92
L	2.92	3.30	3.81

Figure 19. DIP-16L package dimensions

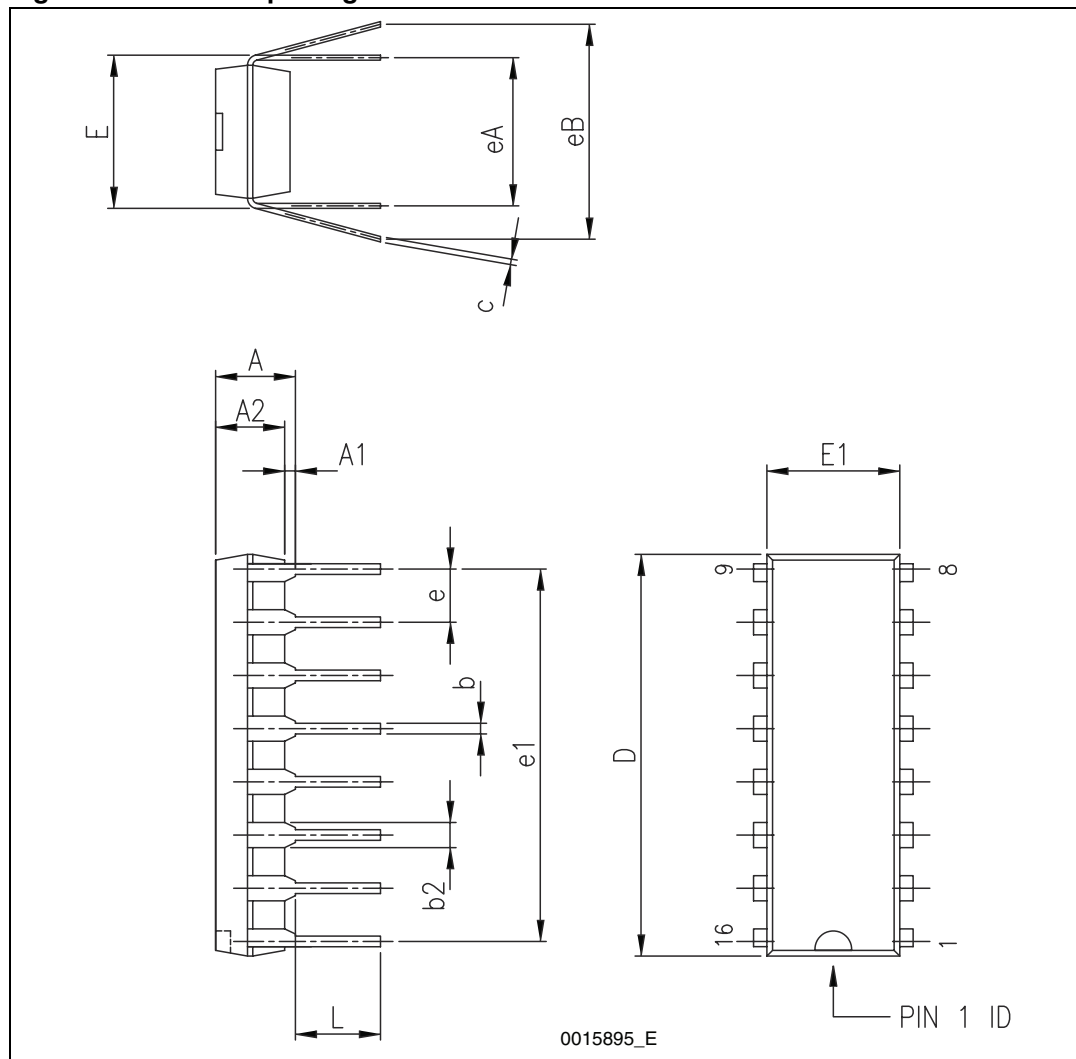
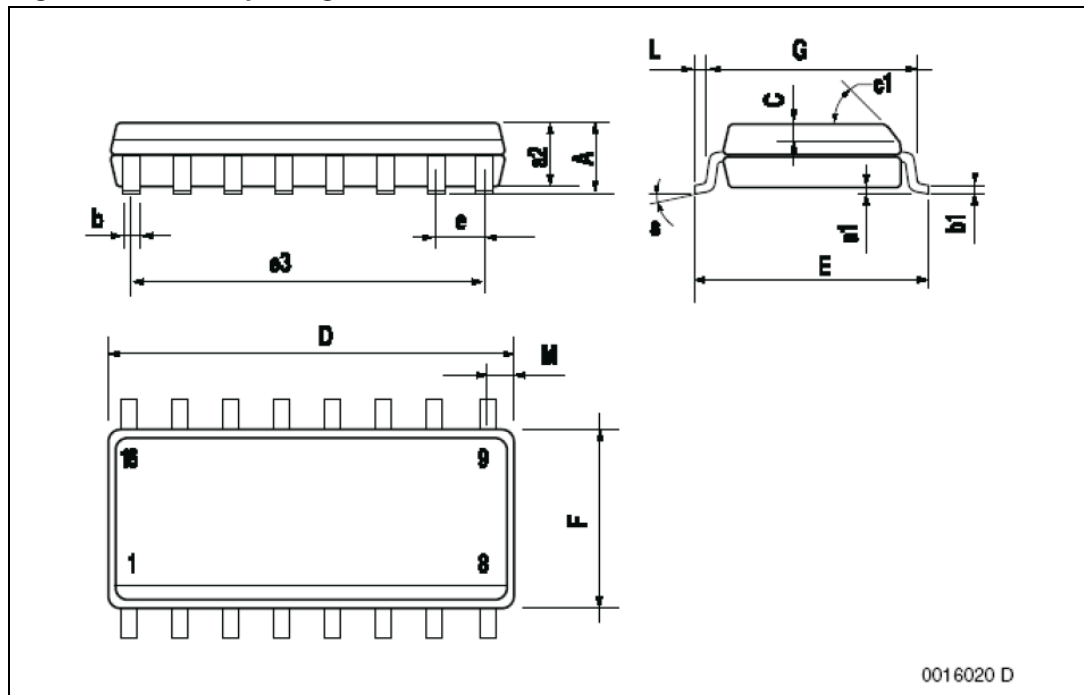

Table 6. SO-16 narrow mechanical data

Dim.	mm.			inch.		
	Min.	Typ.	Max.	Min.	Typ.	Max.
A			1.75			0.069
a1	0.1		0.25	0.004		0.009
a2			1.6			0.063
b	0.35		0.46	0.014		0.018
b1	0.19		0.25	0.007		0.010
C		0.5			0.020	
c1			45°	(typ.)		
D(1)	9.8		10	0.386		0.394
E	5.8		6.2	0.228		0.244
e		1.27			0.050	
e3		8.89			0.350	
F(1)	3.8		4.0	0.150		0.157
G	4.60		5.30	0.181		0.208
L	0.4		1.27	0.150		0.050
M			0.62			0.024
S	8° (max.)					

Figure 20. SO-16 package dimensions



0016020 D

8 Order codes

Table 7. Order codes

Part numbers	Packages
ULN2001A	DIP-16
ULN2002A	DIP-16
ULN2003A	DIP-16
ULN2004A	DIP-16
ULN2001D1013TR	SO-16 in tape and reel
ULN2002D1013TR	SO-16 in tape and reel
ULN2003D1013TR	SO-16 in tape and reel
ULN2004D1013TR	SO-16 in tape and reel

9 Revision history

Table 8. Revision history

Date	Revision	Changes
05-Dec-2006	5	Order code updated and document reformatted.
28-Aug-2007	6	Added Table 1 in cover page.
07-May-2012	7	Modified: Figure 12 on page 9 . Added: Figure 13, 14, 15 and Figure 16 on page 9 .
01-Jun-2012	8	Updated: DIP-16L package mechanical data Table 5 on page 11 and Figure 19 on page 12 .

Please Read Carefully:

Information in this document is provided solely in connection with ST products. STMicroelectronics NV and its subsidiaries ("ST") reserve the right to make changes, corrections, modifications or improvements, to this document, and the products and services described herein at any time, without notice.

All ST products are sold pursuant to ST's terms and conditions of sale.

Purchasers are solely responsible for the choice, selection and use of the ST products and services described herein, and ST assumes no liability whatsoever relating to the choice, selection or use of the ST products and services described herein.

No license, express or implied, by estoppel or otherwise, to any intellectual property rights is granted under this document. If any part of this document refers to any third party products or services it shall not be deemed a license grant by ST for the use of such third party products or services, or any intellectual property contained therein or considered as a warranty covering the use in any manner whatsoever of such third party products or services or any intellectual property contained therein.

UNLESS OTHERWISE SET FORTH IN ST'S TERMS AND CONDITIONS OF SALE ST DISCLAIMS ANY EXPRESS OR IMPLIED WARRANTY WITH RESPECT TO THE USE AND/OR SALE OF ST PRODUCTS INCLUDING WITHOUT LIMITATION IMPLIED WARRANTIES OF MERCHANTABILITY, FITNESS FOR A PARTICULAR PURPOSE (AND THEIR EQUIVALENTS UNDER THE LAWS OF ANY JURISDICTION), OR INFRINGEMENT OF ANY PATENT, COPYRIGHT OR OTHER INTELLECTUAL PROPERTY RIGHT.

UNLESS EXPRESSLY APPROVED IN WRITING BY TWO AUTHORIZED ST REPRESENTATIVES, ST PRODUCTS ARE NOT RECOMMENDED, AUTHORIZED OR WARRANTED FOR USE IN MILITARY, AIR CRAFT, SPACE, LIFE SAVING, OR LIFE SUSTAINING APPLICATIONS, NOR IN PRODUCTS OR SYSTEMS WHERE FAILURE OR MALFUNCTION MAY RESULT IN PERSONAL INJURY, DEATH, OR SEVERE PROPERTY OR ENVIRONMENTAL DAMAGE. ST PRODUCTS WHICH ARE NOT SPECIFIED AS "AUTOMOTIVE GRADE" MAY ONLY BE USED IN AUTOMOTIVE APPLICATIONS AT USER'S OWN RISK.

Resale of ST products with provisions different from the statements and/or technical features set forth in this document shall immediately void any warranty granted by ST for the ST product or service described herein and shall not create or extend in any manner whatsoever, any liability of ST.

ST and the ST logo are trademarks or registered trademarks of ST in various countries.

Information in this document supersedes and replaces all information previously supplied.

The ST logo is a registered trademark of STMicroelectronics. All other names are the property of their respective owners.

© 2012 STMicroelectronics - All rights reserved

STMicroelectronics group of companies

Australia - Belgium - Brazil - Canada - China - Czech Republic - Finland - France - Germany - Hong Kong - India - Israel - Italy - Japan - Malaysia - Malta - Morocco - Philippines - Singapore - Spain - Sweden - Switzerland - United Kingdom - United States of America

www.st.com