

CL-198N Series

Mono-Color Upward-Lighting Type **CL-198N Series**



1.6(L)×0.8(W)×0.25(H)mm

- 小型・超薄型の白色LEDです。
- Compact and ultra-thin white LED

●絶対最大定格 Absolute Maximum Rating^{※1}

(Ta 25°C)

| Product code | Pd (mW) | I _F (mA) | I _{FP} ^{※2} (mA) | V _R (V) | T _{op} (°C) | T _{st} (°C) |
|--------------|---------|---------------------|------------------------------------|--------------------|----------------------|----------------------|
| CL-198N-WS | 38 | 10 | 50 | 5 | -25~+80 | -30~+85 |

※1 1素子当たりの値です。The values are based on 1-die performance.

※2 I_{FP}の条件はduty 1/10、パルス巾30msecです。Conditions for I_{FP} are pulse of 1/10 duty and 30msec width.

●電気的光学的特性 Electro-optical Characteristics

(Ta 25°C)

| Parameter | Symbol | Conditions | MIN | TYP | MAX | Unit |
|--|----------------|---------------------|----------|-------|----------|------|
| 順電圧 Forward Voltage ^{※1} | V _F | I _F =5mA | — | 2.9 | 3.15 | V |
| 逆電流 Reverse Current ^{※1} | I _R | V _R =5V | — | — | 2 | μA |
| 光度 Luminous Intensity ^{※2} | I _v | I _F =5mA | 150 | 300 | — | mcd |
| 色度座標 Chromaticity coordinates ^{※3} | x, y | I _F =5mA | x(±0.02) | | y(±0.02) | |
| | | | a | 0.280 | 0.240 | |
| | | | b | 0.280 | 0.300 | |
| | | | c | 0.350 | 0.390 | |
| d | 0.350 | 0.290 | | | | |

※1 1素子当たりの値です。The values are based on 1-die performance.

※2 NIST規格に準拠、各素子同時点灯の値です。

Compliant with NIST. The values are based on the condition that each die lights simultaneously.

※3 色度座標は、a、b、c、dに囲まれた範囲です。

Chromaticity coordinates are surrounded by points a, b, c, and d.

●外形寸法図 Outline drawing

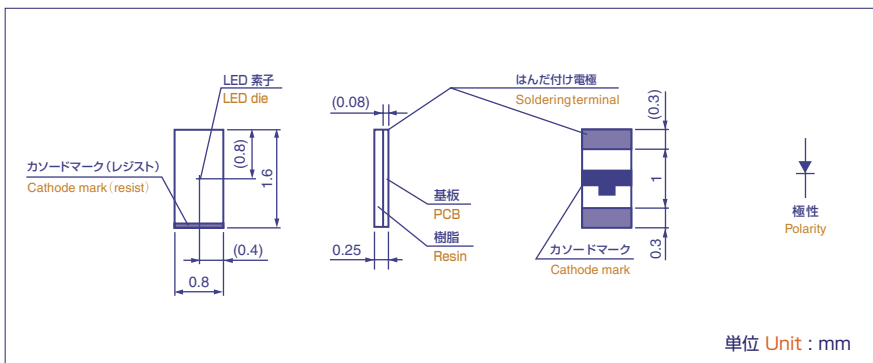

推奨はんだ付けパターン

The following soldering patterns are recommended for reflow-soldering:

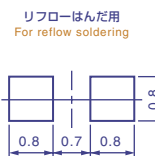

■ 諸特性 Characteristics

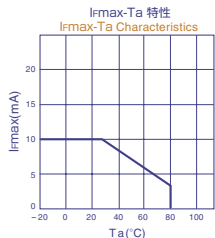
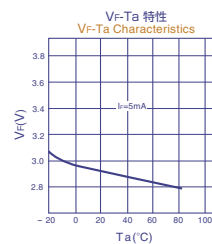
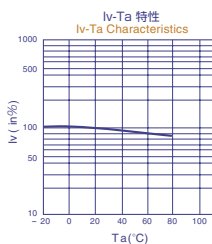
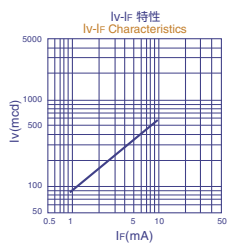
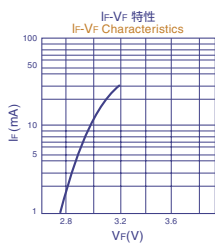

指向特性 Directive Characteristics

