

PLEASE CHECK WWW.MOLEX.COM FOR LATEST PART INFORMATION

Part Number: [5013290222](#)
Status: **Active**
Overview: [inertia lock 330mm wiretowire system](#)
Description: 3.30mm (.130") Pitch Wire-to-Wire Inertia Lock Plug Housing, Single Row, 2 Circuits, Red

Documents:

[Drawing \(PDF\)](#) [RoHS Certificate of Compliance \(PDF\)](#)
[Product Specification PS-501328-001 \(PDF\)](#)

General

Product Family Crimp Housings
 Series [501329](#)
 Overview [inertia lock 330mm wiretowire system](#)
 Product Name Inertia Lock

Physical

Circuits (maximum) 2
 Color - Resin Red
 Gender Male
 Glow-Wire Compliant No
 Lock to Mating Part Yes
 Material - Resin Nylon
 Number of Rows 1
 Packaging Type Bag
 Panel Mount No
 Pitch - Mating Interface (in) 0.130 In
 Pitch - Mating Interface (mm) 3.30 mm
 Polarized to Mating Part Yes
 Stackable No
 Temperature Range - Operating -25°C to +80°C

Electrical

Current - Maximum per Contact 4A

Material Info

Reference - Drawing Numbers

Packaging Specification SPK-501329-001
 Product Specification PS-501328-001, RPS-501328-001, RPS-501328-002, RPS-501328-003
 Sales Drawing SD-501329-001

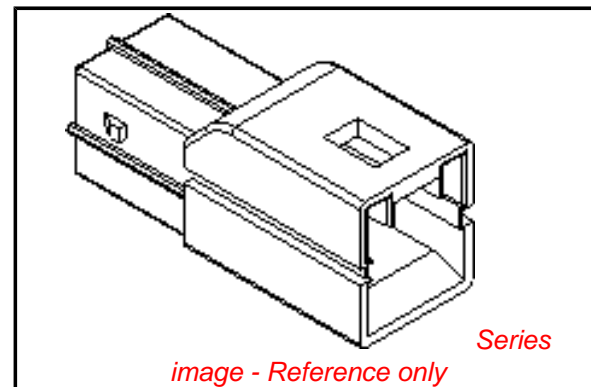

EU RoHS

ELV and RoHS Compliant
REACH SVHC
 Not Reviewed
Halogen-Free Status
 Not Reviewed

China RoHS



Need more information on product environmental compliance?

Email productcompliance@molex.com
 For a multiple part number RoHS Certificate of Compliance, [click here](#)

Please visit the [Contact Us](#) section for any non-product compliance questions.

Search Parts in this Series

[501329Series](#)

Mates With

[501328-0222](#) Receptacle Housing . [501395](#) Receptacle Terminal for AWG#18-20 . [500989](#) Receptacle Terminal for AWG#22-26

Use With

[51348-0213](#) Retainer . [56265](#) Plug Terminal for AWG#18- 20 . [56279](#) Plug Terminal for AWG#22-26

10 9 8 7 6 5 4 3 2 1

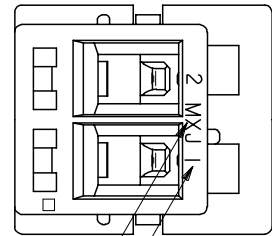

トレードマーク
TRADE MARK.

回路番号
CKT No.

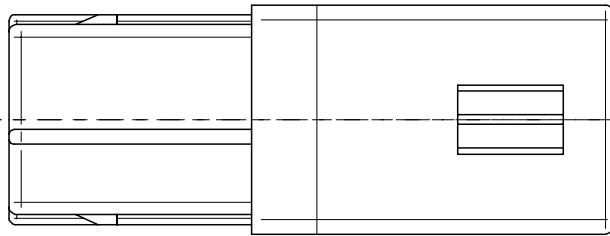

24.5

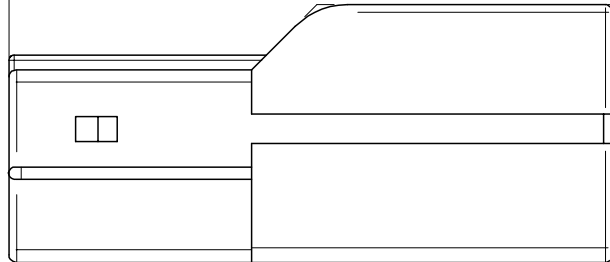

10.45

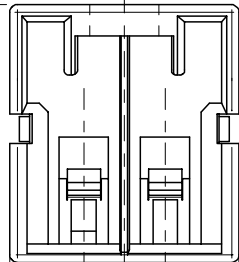

PITCH
3.3
9.3

注記
NOTES.

- △ 適合リテーナ : 51348-0213
APPLICABLE RETAINER
詳細は SD-51348-001 を参照下さい。
REFERENCE:SD-51348-001
- 2. 材料 : NYLON66,UL94V-0
MATERIAL

本形状は 501329-0200 を示す。
SHAPE OF 501329-0200

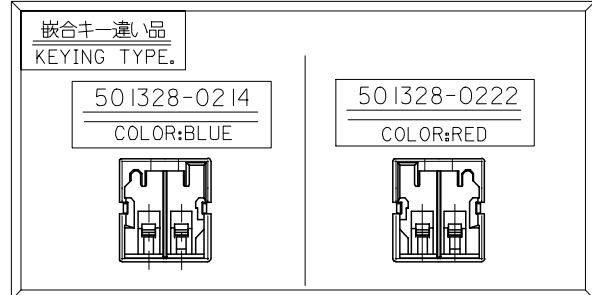
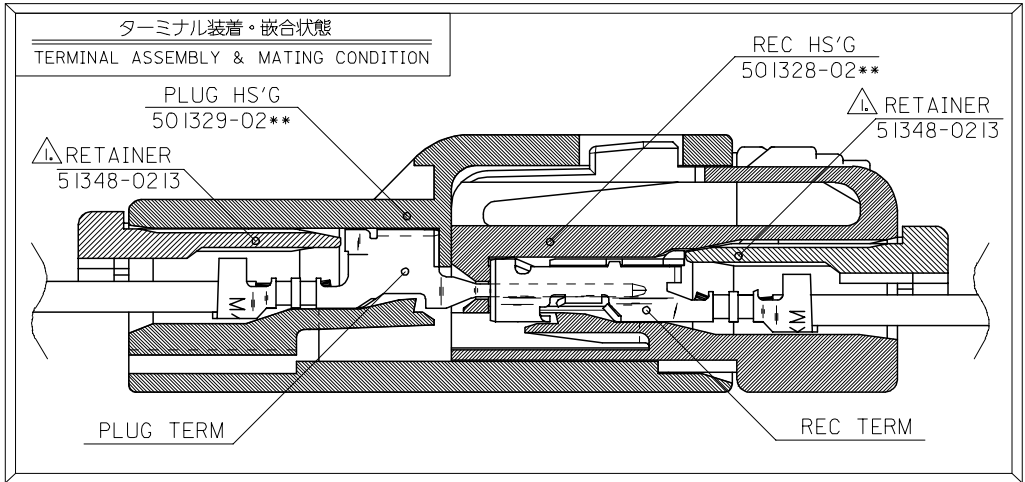

BLUE	501329-0214	501329-02**
RED	501329-0222	
WHITE	501329-0200	
COLOR	MATERIAL No.	MODEL No.

RELEASED EC NO: J2005-2177 DRWN: T.ODA 2005/03/31 CHKD: K.ASAKAWA 2005/03/31 APPR: S.ICHIKAWA 2005/03/31	GENERAL TOLERANCES (UNLESS SPECIFIED)		DIMENSION STYLE MM ONLY		SCALE 5:1	DESIGN UNITS METRIC	THIRD ANGLE PROJECTION	
	10 UNDER	±0.2	DRAWN BY T.ODA		DATE '04/09/30	TITLE 3.3 W/W INERTIA LOCK CONN PLUG 2CKT		
	10 OVER 30 UNDER	±0.25	CHECKED BY K.ASAKAWA		DATE '04/09/30	MOLEX INCORPORATED		
	30 OVER	±0.3	APPROVED BY S.ICHIKAWA		DATE '04/09/30	DOCUMENT NO. SD-501329-001	SHEET NO. 1 OF 1	
	ANGULAR	±3 °	MATERIAL NO. SEE CHART					
DRAFT WHERE APPLICABLE MUST REMAIN WITHIN DIMENSIONS		SIZE A3		THIS DRAWING CONTAINS INFORMATION THAT IS PROPRIETARY TO MOLEX INCORPORATED AND SHOULD NOT BE USED WITHOUT WRITTEN PERMISSION				