

ATF-53189

Enhancement Mode^[1] Pseudomorphic HEMT in SOT 89 Package



Data Sheet

Description

Avago Technologies's ATF-53189 is a single-voltage high linearity, low noise E-pHEMT FET packaged in a low cost surface mount SOT89 package. The device is ideal as a high-linearity, low noise, medium-power amplifier. Its operating frequency range is from 50 MHz to 6 GHz.

ATF-53189 is ideally suited for Cellular/PCS and WCDMA wireless infrastructure, WLAN, WLL and MMDS application, and general-purpose discrete E-pHEMT amplifiers that require medium power and high linearity. All devices are 100% RF and DC tested.

Pin Connections and Package Marking

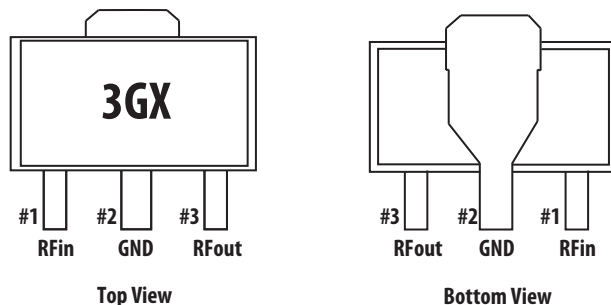

Notes:

Package marking provides orientation and identification:

"3G" = Device Code

"x" = Month code indicates the month of manufacture.

D = Drain

S = Source

G = Gate

Features

- Single voltage operation
- High Linearity and Gain
- Low Noise Figure
- Excellent uniformity in product specifications
- SOT 89 standard package
- Point MTTF > 300 years^[2]
- MSL-1 and lead-free
- Tape-and-Reel packaging option available

Specifications

2 GHz, 4.0V, 135 mA (Typ.)

- 40.0 dBm Output IP3
- 23.0 dBm Output Power at 1dB gain compression
- 0.85 dB Noise Figure
- 15.5 dB Gain
- 46% PAE at P1dB
- LFOM^[3] 12.7 dB

Applications

- Front-end LNA Q1 and Q2, Driver or Pre-driver Amplifier for Cellular/PCS and WCDMA wireless infrastructure
- Driver Amplifier for WLAN, WLL/RLL and MMDS applications
- General purpose discrete E-pHEMT for other high linearity applications

Notes:

1. Enhancement mode technology employs a single positive V_{gs} , eliminating the need of negative gate voltage associated with conventional depletion mode devices.

2. Refer to reliability datasheet for detailed MTTF data.

3. Linearity Figure of Merit (LFOM) is OIP3 divided by DC bias power.

ATF-53189 Absolute Maximum Ratings^[1]

Symbol	Parameter	Units	Absolute Maximum
V_{ds}	Drain-Source Voltage ^[2]	V	7
V_{gs}	Gate-Source Voltage ^[2]	V	-5 to 1.0
V_{gd}	Gate Drain Voltage ^[2]	V	-5 to 1.0
I_{ds}	Drain Current ^[2]	mA	300
I_{gs}	Gate Current	mA	20
P_{diss}	Total Power Dissipation ^[3]	W	1.0
$P_{in\ max.}$	RF Input Power	dBm	+24
T_{ch}	Channel Temperature	°C	150
T_{stg}	Storage Temperature	°C	-65 to 150

Thermal Resistance^[2,4]

$$\theta_{ch-b} = 70^{\circ}\text{C}/\text{W}$$

Notes:

1. Operation of this device above any one of these parameters may cause permanent damage.
2. Assuming DC quiescent conditions.
3. Board (package belly) temperature T_B is 25°C. Derate 14.30 mW/°C for $T_B > 80^{\circ}\text{C}$.
4. Channel-to-board thermal resistance measured using 150°C Liquid Crystal Measurement method.

ATF-53189 Electrical Specifications

$T_A = 25^{\circ}\text{C}$, DC bias for RF parameters is $V_{ds} = 4.0\text{V}$ and $I_{ds} = 135\text{ mA}$ unless otherwise specified.

Symbol	Parameters and Test Conditions	Units	Min.	Typ.	Max.	
V_{gs}	Operational Gate Voltage	$V_{ds} = 4.0\text{V}, I_{ds} = 135\text{ mA}$	V	—	0.65	—
V_{th}	Threshold Voltage	$V_{ds} = 4.0\text{V}, I_{ds} = 8\text{ mA}$	V	—	0.30	—
I_{ds}	Drain to Source Current	$V_{ds} = 4.0\text{V}, V_{gs} = 0\text{V}$	μA	—	3.70	—
G_m	Transconductance	$V_{ds} = 4.0\text{V}, G_m = \Delta I_{ds} / \Delta V_{gs};$ $\Delta V_{gs} = V_{gs1} - V_{gs2}$ $V_{gs1} = 0.6\text{V}, V_{gs2} = 0.55\text{V}$	mmho	—	650	—
I_{gss}	Gate Leakage Current	$V_{ds} = 0\text{V}, V_{gs} = -4\text{V}$	μA	-10.0	-0.34	—
NF	Noise Figure	f=900 MHz f=2.0 GHz f=2.4 GHz	dB	—	0.80 0.85 1.00	— 1.3 —
G	Gain ^[1]	f=900 MHz f=2.0 GHz f=2.4 GHz	dB	— 14.0 —	17.2 15.5 15.0	— 17.0 —
OIP3	Output 3rd Order Intercept Point ^[1]	f=900 MHz f=2.0 GHz f=2.4 GHz	dBm	— 36.0 —	42.0 40.0 38.6	— — —
P1dB	Output 1dB Compressed ^[1]	f=900 MHz f=2.0 GHz f=2.4 GHz	dBm	— — —	21.7 23.0 23.2	— — —
PAE	Power Added Efficiency	f=900 MHz f=2.0 GHz f=2.4 GHz	%	— — —	33.8 46.0 49.0	— — —
ACLR	Adjacent Channel Leakage Power Ratio ^[1,2]	Offset BW = 5 MHz Offset BW = 10 MHz	dBc	— —	-54.0 -64.0	— —

Notes:

1. Measurements at 2 GHz obtained using production test board described in Figure 1.
2. ACLR test spec is based on 3GPP TS 25.141 V5.3.1 (2002-06)
 - Test Model 1
 - Active Channels: PCCPCH + SCH + CPICH + PICH + SCCPCH + 64 DPCH (SF=128)
 - Freq = 2140 MHz
 - Pin = -8 dBm
 - Channel Integrate Bandwidth = 3.84 MHz

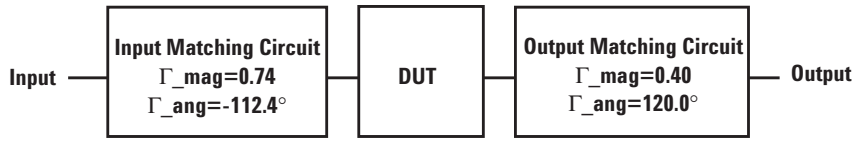

Figure 1. Block diagram of the 2 GHz production test board used for NF, Gain, OIP3, P1dB, PAE and ACLR measurements. This circuit achieves a trade-off between optimal OIP3, P1dB and VSWR. Circuit losses have been de-embedded from actual measurements.

Product Consistency Distribution Charts ^[1,2]

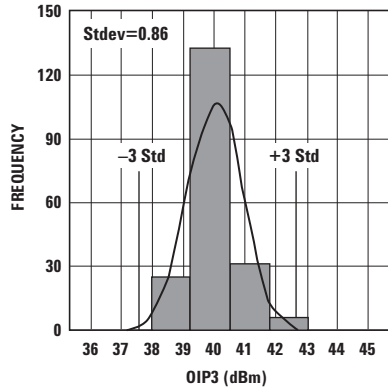

Figure 2. OIP3 @ 2 GHz, 4V, 135 mA.
LSL = 36 dBm, Nominal = 40 dBm.

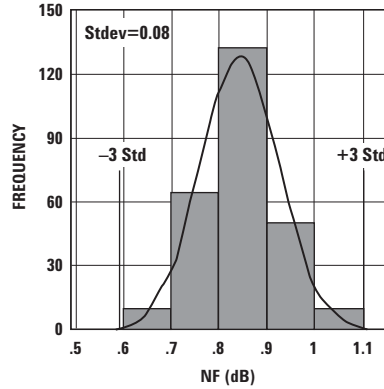

Figure 3. NF @ 2 GHz, 4V, 135 mA.
USL = 1.30 dBm, Nominal = 0.84 dBm.

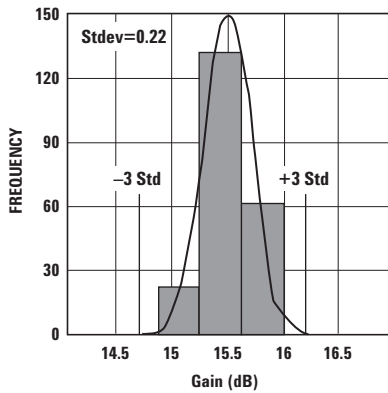

Figure 4. Gain @ 2 GHz, 4V, 135 mA.
LSL = 14 dBm, Nominal = 15.5 dBm,
USL = 17 dBm.

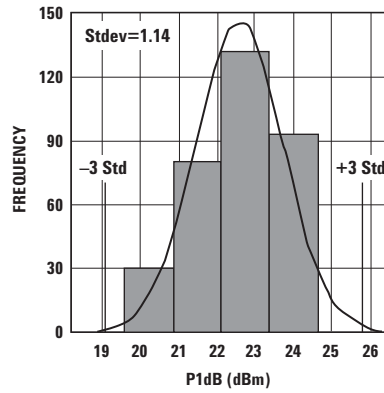

Figure 5. P1dB @ 2 GHz, 4V, 135 mA.
Nominal = 23 dBm.

Notes:

1. Distribution data sample size is 500 samples taken from 3 different wafers. Future wafers allocated to this product may have nominal values anywhere between the upper and lower limits.
2. Measurements are made on production test board, which represents a trade-off between optimal OIP3, P1dB and VSWR. Circuit losses have been de-embedded from actual measurements.

Gamma Load and Source at Optimum OIP3 Tuning Conditions

The device's optimum OIP3 measurements were determined using a Maury Load Pull System at 4.0V, 135 mA quiesent bias.

Typical Gammas at Optimum OIP3^[1]

Freq (GHz)	Gamma Source		Gamma Load		OIP3 (dBm)	Gain (dB)	P1dB (dBm)	PAE (%)
	Mag	Ang (deg)	Mag	Ang (deg)				
0.9	0.8179	-143.28	0.0721	124.08	42.0	17.2	21.7	33.8
2.0	0.7411	-112.36	0.4080	119.91	41.6	15.6	23.4	44.2
3.9	0.6875	-94.23	0.4478	174.74	41.3	11.2	23.1	41.4
5.8	0.5204	-75.91	0.3525	-120.13	36.9	5.6	22.4	25.7

Note:

1. Typical describes additional product performance information that is not covered by the product warranty.

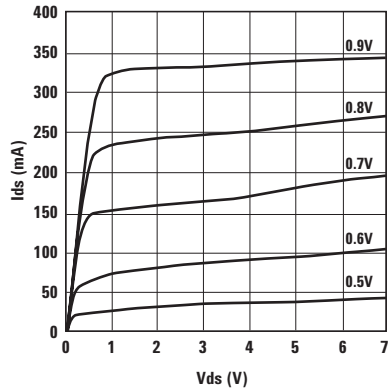

Figure 6. Typical IV Curve.

ATF-53189 Typical Performance Curves (at 25°C unless specified otherwise)

Tuned for Optimal OIP3 at $V_d = 4.0V$, $I_{ds} = 135\text{ mA}$.

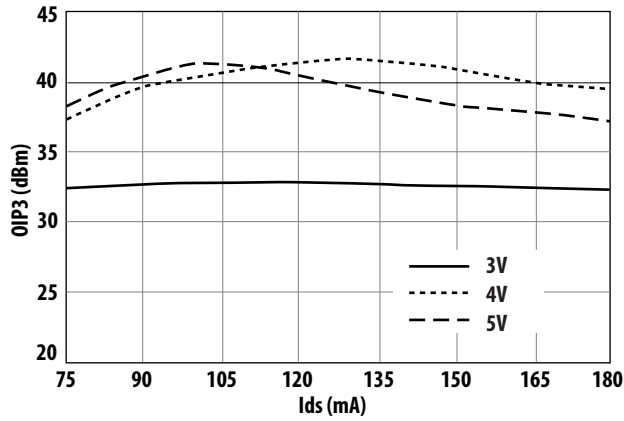

Figure 7. OIP3 vs. I_{ds} and V_{ds} at 900 MHz

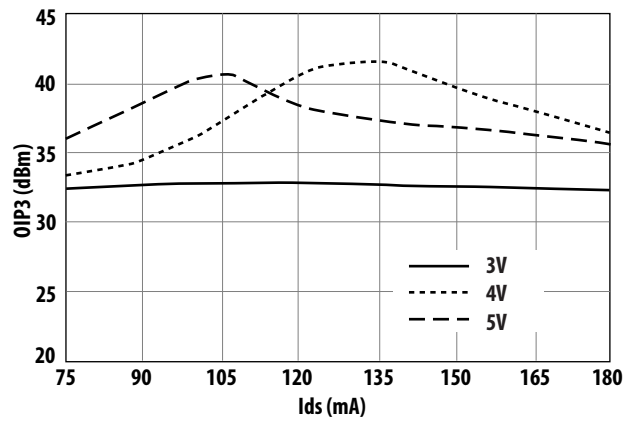

Figure 8. OIP3 vs. I_{ds} and V_{ds} at 2 GHz

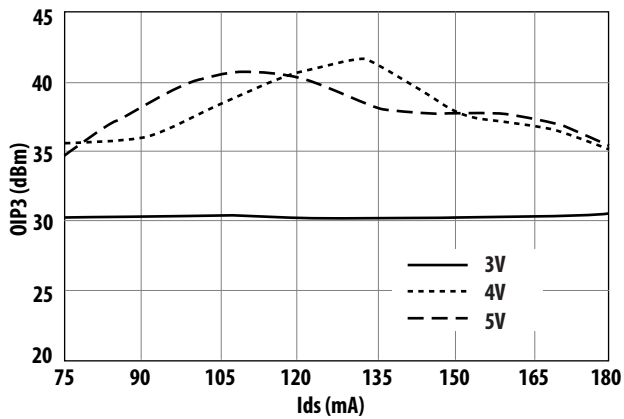

Figure 9. OIP3 vs. I_{ds} and V_{ds} at 3.9 GHz

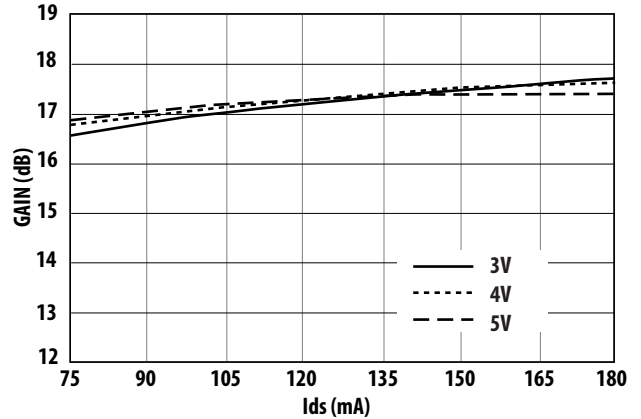

Figure 10. Small Signal Gain vs. I_{ds} and V_{ds} at 900 MHz

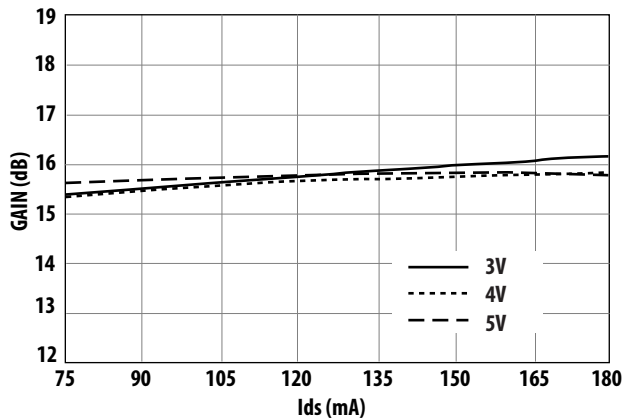

Figure 11. Small Signal Gain vs. I_{ds} and V_{ds} at 2 GHz

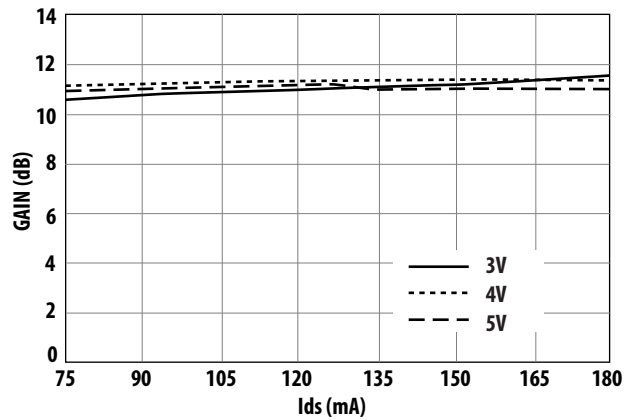

Figure 12. Small Signal Gain vs. I_{ds} and V_{ds} at 3.9 GHz

Note:

Bias current for these charts are quiescent conditions. Actual level may increase depending on amount of RF drive.

ATF-53189 Typical Performance Curves (at 25°C unless specified otherwise), continued
Tuned for Optimal OIP3 at Vd = 4.0V, Ids = 135 mA.

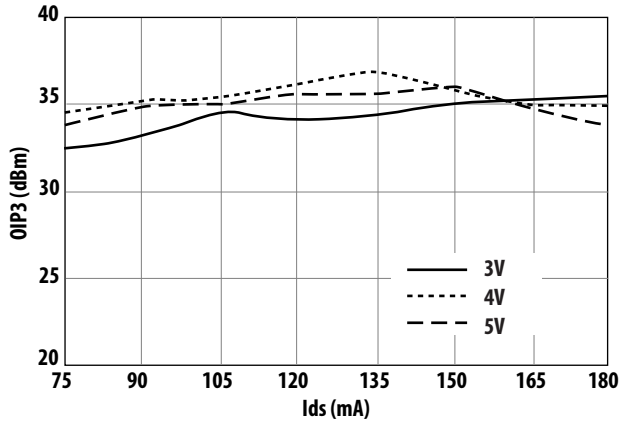

Figure 13. OIP3 vs. Ids and Vds at 5.8 GHz

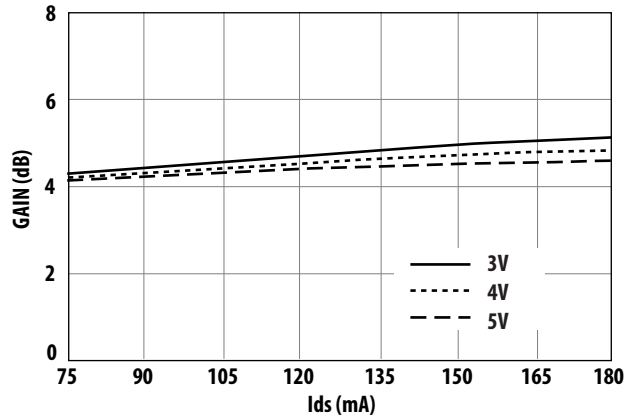

Figure 14. Small Signal Gain vs. Ids and Vds at 5.8 GHz

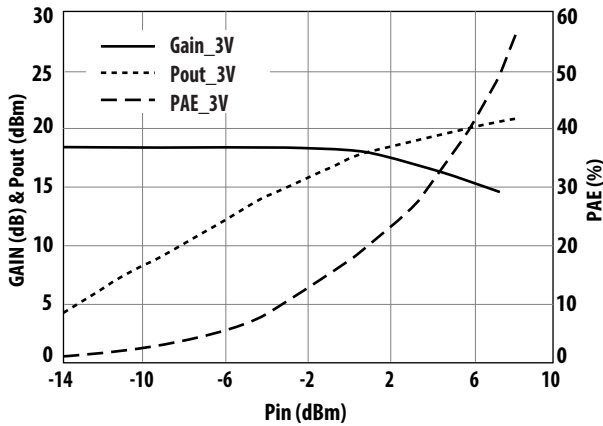

Figure 15. Small Signal Gain/Pout/PAE vs. Pin at Vds=3V and Freq=900 MHz

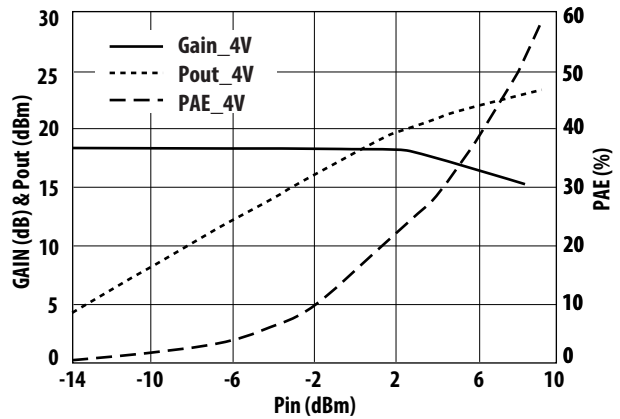

Figure 16. Small Signal Gain/Pout/PAE vs. Pin at Vds=4V and Freq=900 MHz

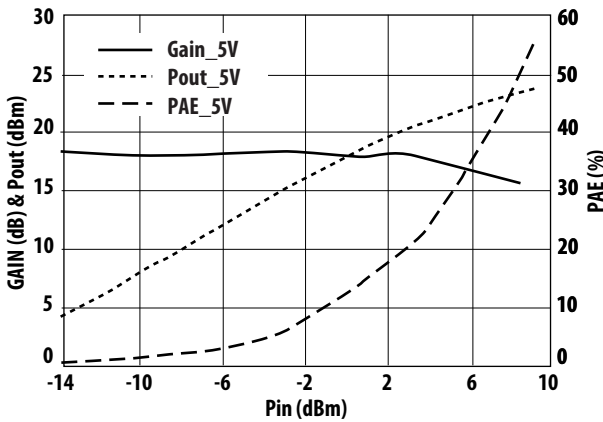

Figure 17. Small Signal Gain/Pout/PAE vs. Pin at Vds=5V and Freq=900 MHz

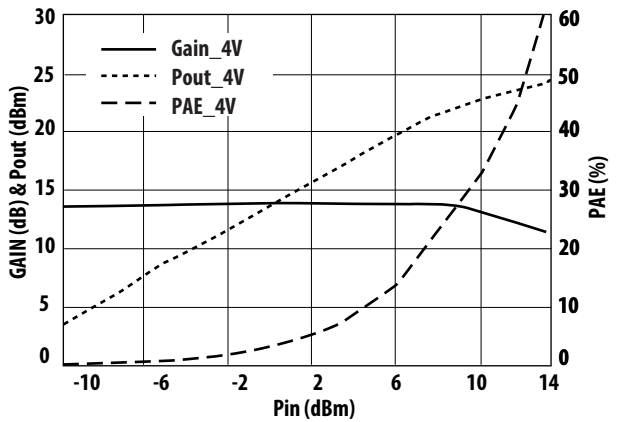

Figure 18. Small Signal Gain/Pout/PAE vs. Pin at Vds=3V and Freq=2 GHz

Note:

Bias current for these charts are quiescent conditions. Actual level may increase depending on amount of RF drive.

ATF-53189 Typical Performance Curves (at 25°C unless specified otherwise), continued
Tuned for Optimal OIP3 at Vd = 4.0V, Ids = 135 mA.

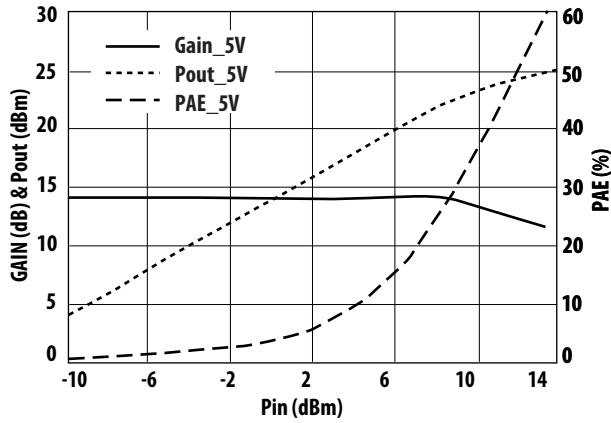

Figure 19. Small Signal Gain/Pout/PAE vs. Pin at Vds=4V and Freq = 2 GHz

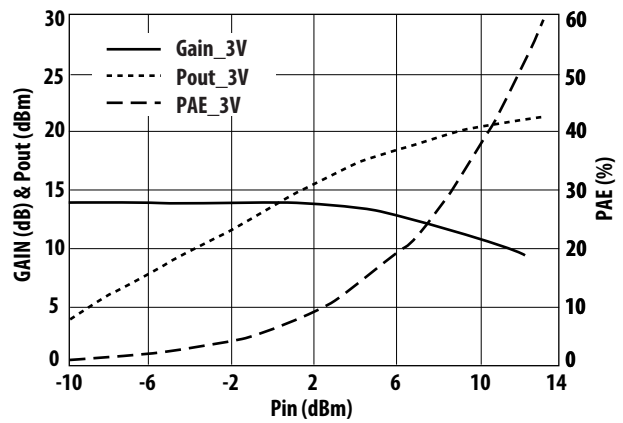

Figure 20. Small Signal Gain/Pout/PAE vs. Pin at Vds=5V and Freq = 2 GHz

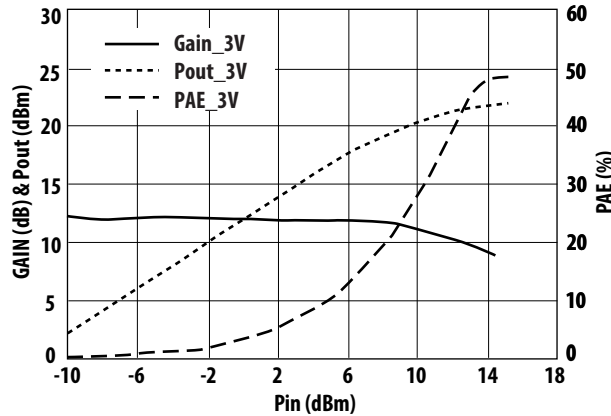

Figure 21. Small Signal Gain/Pout/PAE vs. Pin at Vds=3V and Freq=3.9 GHz

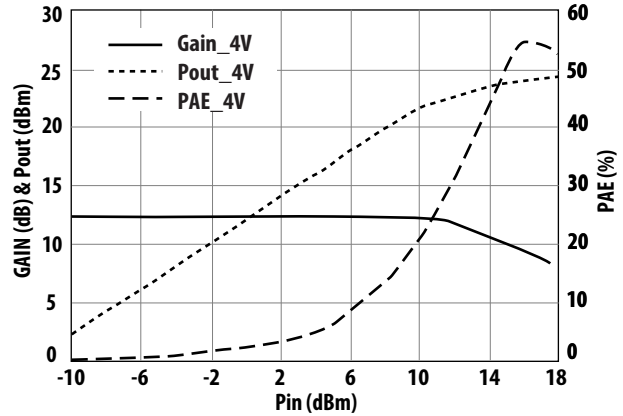

Figure 22. Small Signal Gain/Pout/PAE vs. Pin at Vds=4V and Freq=3.9 GHz

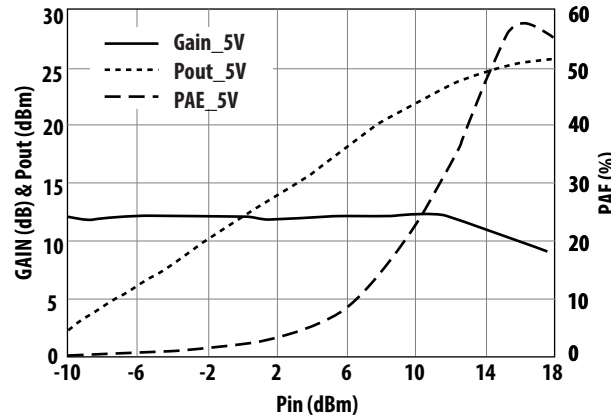

Figure 23. Small Signal Gain/Pout/PAE vs. Pin at Vds=5V and Freq=3.9 GHz

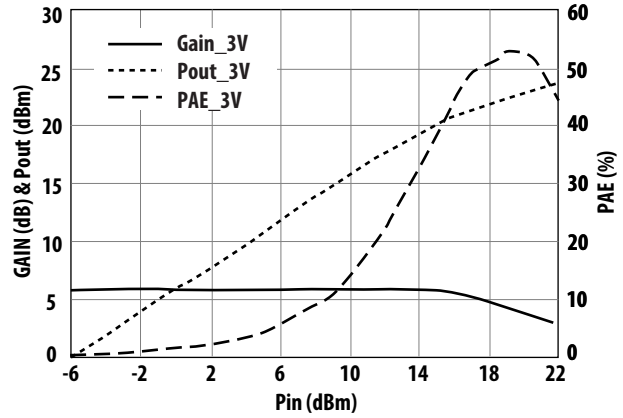

Figure 24. Small Signal Gain/Pout/PAE vs. Pin at Vds=3V and Freq=5.8 GHz

Note:

Bias current for the above charts are quiescent conditions. Actual level may increase depending on amount of RF drive.

ATF-53189 Typical Performance Curves (at 25°C unless specified otherwise), continued
Tuned for Optimal OIP3 at Vd = 4.0V, Ids = 135 mA.

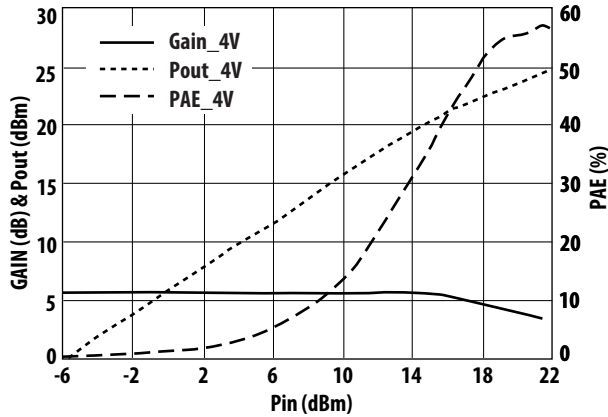

Figure 25. Small Signal Gain/Pout/PAE vs. Pin at Vds=4V and Freq=5.8 GHz

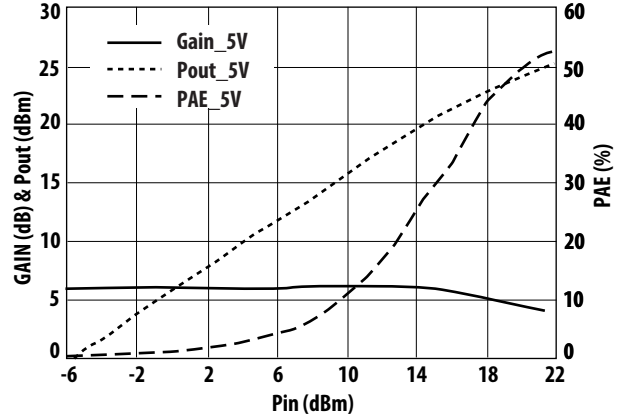

Figure 26. Small Signal Gain/Pout/PAE vs. Pin at Vds=5V and Freq=5.8 GHz

ATF-53189 Typical Performance Curves, continued
Tuned for Optimal OIP3 at Vd = 4.0V, Ids = 135 mA, Over Temperature and Frequency

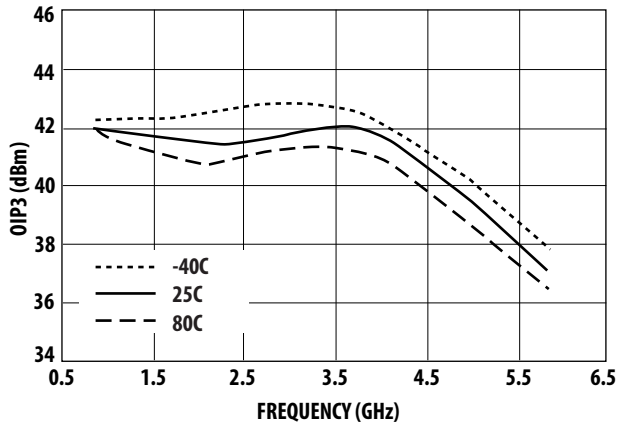

Figure 27. OIP3 vs. Temperature and Frequency at optimum OIP3

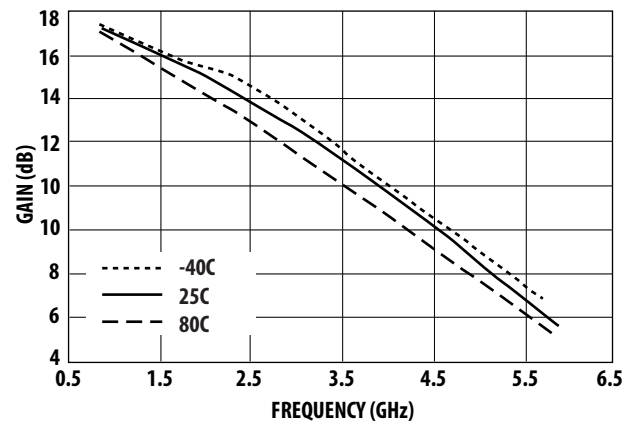

Figure 28. Gain vs. Temperature and Frequency at optimum OIP3

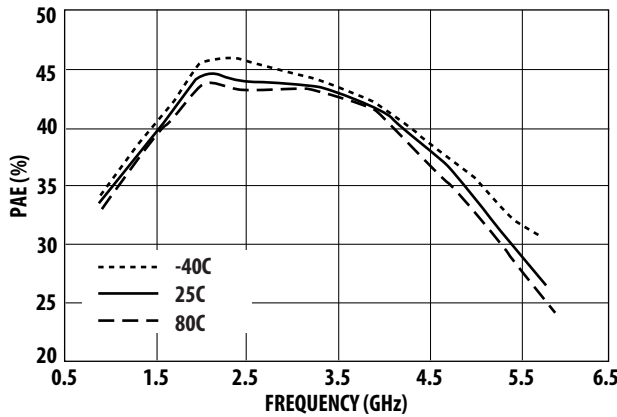

Figure 29. PAE vs. Temperature and Frequency at optimum OIP3

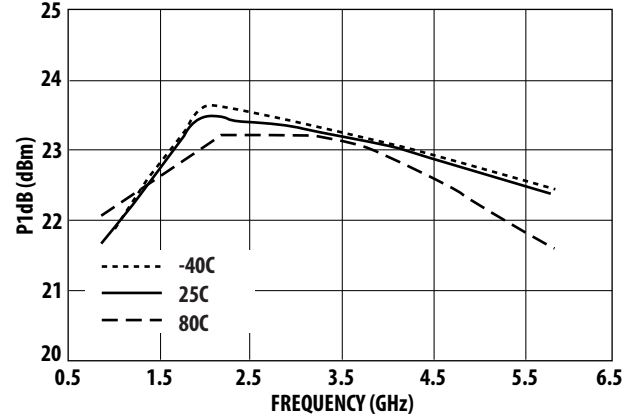
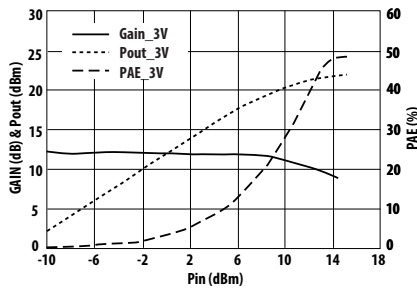
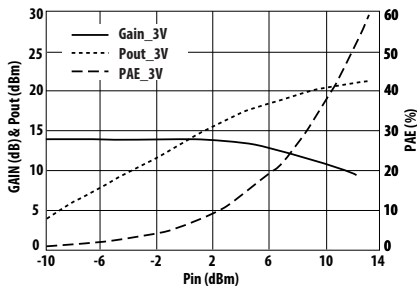
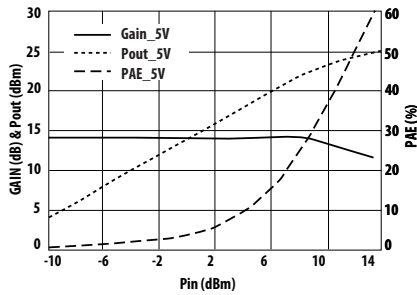
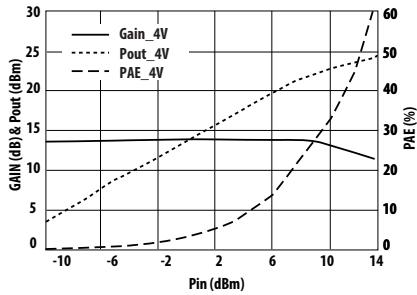
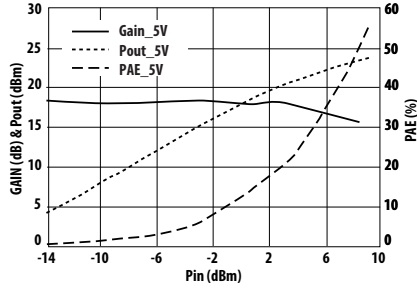
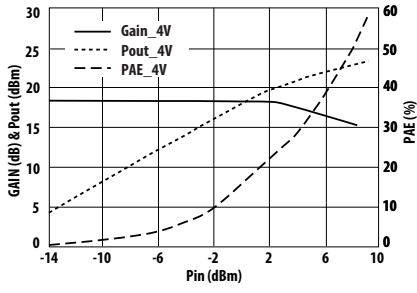

Figure 30. P1dB vs. Temperature and Frequency at optimum OIP3

Note:

Bias current for the above charts are quiescent conditions. Actual level may increase depending on amount of RF drive.

ATF-53189 Typical Performance Curves (at 25°C unless specified otherwise), continued
Tuned for Optimal OIP3 at Vd = 4.0V, Ids = 135 mA



Note:

Bias current for the above charts are quiescent conditions. Actual level may increase depending on amount of RF drive.

ATF-53189 Typical Scattering and Noise Parameters at 25°C, $V_{DS} = 4.0V$, $I_{DS} = 180\text{ mA}$

Freq. GHz	S_{11}			S_{21}			S_{12}		S_{22}		MSG/MAG dB
	Mag.	Ang.	dB	Mag.	Ang.	dB	Mag.	Ang.	Mag.	Ang.	
0.1	0.776	-48.1	32.2	40.839	154.1	-38.4	0.012	65.5	0.428	-39.3	35.3
0.2	0.798	-84.7	30.7	34.138	135.6	-34.0	0.02	50.5	0.411	-71.3	32.3
0.3	0.818	-110.2	29.0	28.059	121.7	-32.0	0.025	39.4	0.396	-94.8	30.5
0.4	0.832	-128.2	27.3	23.278	111.2	-31.4	0.027	31.7	0.384	-111.6	29.4
0.5	0.835	-151.9	24.8	17.424	100.1	-31.7	0.026	23.3	0.397	-146.6	28.3
0.6	0.84	-160.3	23.4	14.811	94.8	-31.7	0.026	20.5	0.401	-153.7	27.6
0.7	0.842	-166.9	22.2	12.876	90.2	-31.4	0.027	18.6	0.403	-159	26.8
0.8	0.843	-172.2	21.1	11.394	86.3	-31.4	0.027	17.5	0.402	-163.3	26.3
0.9	0.844	-176.9	20.2	10.225	82.7	-31.1	0.028	16.5	0.4	-166.8	25.6
1.0	0.847	178.8	19.3	9.256	79.3	-31.1	0.028	15.7	0.398	-169.8	25.2
1.5	0.847	161.9	16.0	6.316	64.7	-30.2	0.031	13.4	0.389	178.4	23.1
2.0	0.847	147.6	13.7	4.818	51.4	-29.4	0.034	11	0.377	169.3	21.5
2.5	0.843	133.8	11.9	3.928	38.4	-28.6	0.037	7.6	0.367	160.5	18.9
3.0	0.841	119.8	10.6	3.369	25.2	-28.0	0.04	2.5	0.365	152.5	17.0
3.5	0.851	110	9.6	3.036	14.5	-27.5	0.042	-2.4	0.385	143.8	16.3
4.0	0.862	100.1	8.6	2.702	3.7	-27.3	0.043	-7.3	0.405	135.2	15.5
5.0	0.882	80.4	6.2	2.034	-17.9	-26.9	0.045	-17.2	0.446	117.8	13.5
6.0	0.903	60.7	2.7	1.367	-39.4	-26.4	0.048	-27	0.486	100.5	10.8
7.0	0.939	44	0.2	1.027	-59.4	-27.1	0.044	-37.6	0.544	87.1	10.5
8.0	0.956	31.8	-2.1	0.786	-77.8	-27.7	0.041	-48.7	0.607	72.6	10.0
9.0	0.94	23.2	-4.6	0.586	-94.2	-29.1	0.035	-61.5	0.669	57.9	6.7
10.0	0.948	13.6	-6.8	0.459	-110	-30.8	0.029	-79	0.721	45.5	6.1
11.0	0.942	2.6	-8.7	0.368	-126.9	-34.0	0.02	-117	0.756	35.1	4.8
12.0	0.92	-4.3	-10.3	0.305	-141.2	-38.4	0.012	-172.6	0.784	24.8	2.3
13.0	0.959	-15.4	-12.3	0.244	-161.1	-35.4	0.017	104.4	0.794	15.1	3.7
14.0	0.952	-20.1	-14.3	0.193	-171.7	-35.4	0.017	73.2	0.812	7.6	0.8
15.0	0.943	-21	-15.5	0.168	179.4	-35.9	0.016	82.9	0.847	1.3	-0.3
16.0	0.956	-24.2	-16.2	0.155	169.6	-34.0	0.02	81.5	0.852	-2.9	0.3
17.0	0.959	-31.9	-16.0	0.159	155.5	-31.4	0.027	87	0.865	-7.8	1.5
18.0	0.918	-43.5	-15.7	0.164	137.8	-28.4	0.038	78.1	0.847	-14.7	-2.0

Freq GHz	Fmin dB	Gamma Opt		Rn/50	Ga dB
		Mag	Ang		
0.5	0.65	0.394	163.6	0.11	25.82
0.9	0.76	0.417	172.4	0.09	21.83
1.0	0.79	0.423	175.3	0.08	21.71
1.5	0.86	0.465	-165.4	0.08	18.70
2.0	0.94	0.509	-147.7	0.06	17.63
2.4	1.00	0.545	-134.6	0.08	16.45
3.0	1.10	0.600	-116.7	0.16	14.90
3.5	1.17	0.645	-103.3	0.28	13.53
5.0	1.41	0.777	-70.0	0.35	11.35
5.8	1.53	0.840	-56.1	0.41	10.31
6.0	1.56	0.855	-52.9	0.42	10.38
7.0	1.72	0.920	-39.0	0.51	9.79
8.0	1.87	0.970	-27.5	0.97	7.91
9.0	2.03	0.993	-19.1	1.88	6.11
10.0	2.18	0.997	-7.5	2.54	4.56

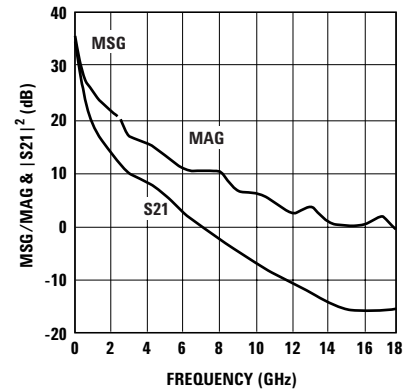

Figure 36. MSG/MAG & $|S_{21}|^2$ vs. and Frequency at 4.0V/180 mA.

Notes:

1. F_{min} values at 2 GHz and higher are based on measurements while the F_{min} below 2 GHz have been extrapolated. The F_{min} values are based on a set of 16 noise figure measurements made at 16 different impedances using an ATN NP5 test system. From these measurements a true F_{min} is calculated. Refer to the noise parameter application section for more information.
2. S and noise parameters are measured on a microstrip line made on 0.025 inch thick alumina carrier. The input reference plane is at the end of the gate lead. The output reference plane is at the end of the drain lead.

ATF-53189 Typical Scattering and Noise Parameters at 25°C, $V_{DS} = 4.0V$, $I_{DS} = 135$ mA

Freq. GHz	S_{11}			S_{21}			S_{12}		S_{22}		MSG/MAG dB
	Mag.	Ang.	dB	Mag.	Ang.	dB	Mag.	Ang.	Mag.	Ang.	
0.1	0.916	-47.6	32.6	42.775	152.6	-37.7	0.013	66.7	0.458	-40.7	35.2
0.2	0.897	-83.9	30.9	35.086	133.4	-33.2	0.022	49.5	0.43	-73.3	32.0
0.3	0.885	-109.5	29.1	28.4	119.5	-31.4	0.027	37.8	0.407	-96.8	30.2
0.4	0.878	-127.5	27.4	23.322	109.2	-30.8	0.029	29.9	0.39	-113.4	29.1
0.5	0.859	-151.3	24.8	17.286	98.2	-31.4	0.027	21.3	0.399	-148.1	28.1
0.6	0.857	-159.9	23.3	14.647	93.1	-31.1	0.028	18.6	0.401	-155	27.2
0.7	0.855	-166.5	22.1	12.703	88.7	-31.1	0.028	16.9	0.402	-160.1	26.6
0.8	0.854	-171.9	21.0	11.225	84.9	-30.8	0.029	15.6	0.4	-164.3	25.9
0.9	0.852	-176.6	20.1	10.065	81.5	-30.8	0.029	14.6	0.398	-167.7	25.4
1.0	0.854	179.1	19.2	9.101	78.2	-30.8	0.029	13.9	0.396	-170.6	25.0
1.5	0.851	162.1	15.8	6.197	63.9	-29.9	0.032	11.3	0.386	178	22.9
2.0	0.85	147.7	13.5	4.726	50.7	-29.4	0.034	9	0.374	169	21.4
2.5	0.846	133.9	11.7	3.851	37.7	-28.4	0.038	5.7	0.364	160.4	19.3
3.0	0.844	119.8	10.4	3.301	24.6	-28.0	0.04	0.8	0.362	152.4	17.0
3.5	0.854	110	9.4	2.968	13.9	-27.7	0.041	-4	0.382	143.7	16.2
4.0	0.863	100.2	8.4	2.636	3.1	-27.5	0.042	-8.7	0.401	135	15.3
5.0	0.883	80.5	5.9	1.972	-18.5	-26.9	0.045	-18.1	0.441	117.6	13.3
6.0	0.902	60.8	2.3	1.308	-40	-26.6	0.047	-27.6	0.48	100.2	10.3
7.0	0.939	44.1	0.0	1.005	-60	-27.1	0.044	-38.6	0.542	87.3	10.3
8.0	0.956	31.8	-2.3	0.769	-78.3	-27.7	0.041	-49.6	0.605	72.8	9.8
9.0	0.94	23.2	-4.8	0.573	-95	-29.1	0.035	-62.1	0.668	58.1	6.6
10.0	0.948	13.6	-7.0	0.448	-110.5	-30.8	0.029	-80	0.721	45.6	5.9
11.0	0.942	2.6	-8.9	0.36	-127.7	-34.0	0.02	-118.6	0.757	35.2	4.6
12.0	0.92	-4.2	-10.5	0.297	-141.8	-38.4	0.012	-173.3	0.784	24.8	2.1
13.0	0.959	-15.4	-12.4	0.239	-161.9	-34.9	0.018	105	0.794	15.1	3.5
14.0	0.951	-20	-14.5	0.188	-172.9	-35.4	0.017	74	0.812	7.7	0.4
15.0	0.942	-21.1	-15.7	0.164	178.7	-35.4	0.017	84.5	0.847	1.4	-0.6
16.0	0.956	-24.2	-16.5	0.149	167.8	-34.0	0.02	82.4	0.853	-2.9	0.0
17.0	0.958	-31.8	-16.2	0.155	154.1	-31.4	0.027	87.3	0.866	-7.8	1.2
18.0	0.92	-43.5	-15.9	0.161	136.9	-28.4	0.038	78.5	0.848	-14.7	-2.1

Freq GHz	Fmin dB	Gamma Opt		Rn/50	Ga dB
		Mag	Ang		
0.5	0.30	0.162	150.8	0.05	26.27
0.9	0.41	0.291	161.3	0.05	22.12
1.0	0.44	0.302	164.2	0.05	22.02
1.5	0.53	0.369	-174.2	0.04	18.95
2.0	0.62	0.433	-154.6	0.04	17.05
2.4	0.69	0.484	-140.2	0.05	15.87
3.0	0.80	0.556	-120.6	0.10	14.63
3.5	0.89	0.613	-106.1	0.19	13.21
5.0	1.16	0.764	-71.0	0.26	11.19
5.8	1.31	0.832	-56.6	0.30	10.26
6.0	1.34	0.848	-53.4	0.30	10.04
7.0	1.52	0.914	-39.3	0.39	9.64
8.0	1.71	0.963	-27.9	0.77	8.68
9.0	1.89	0.991	-18.2	0.96	6.57
10.0	2.07	0.998	-9.2	1.58	4.51

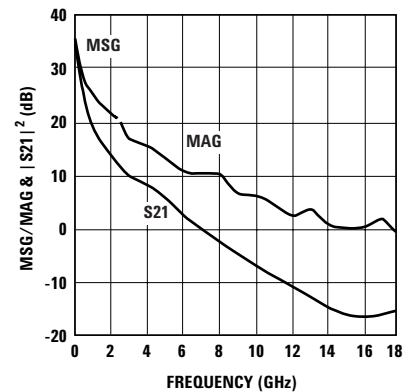

Figure 37. MSG/MAG & $|S_{21}|^2$ vs. and Frequency at 4.0V/135 mA.

Notes:

1. F_{min} values at 2 GHz and higher are based on measurements while the F_{min} below 2 GHz have been extrapolated. The F_{min} values are based on a set of 16 noise figure measurements made at 16 different impedances using an ATN NP5 test system. From these measurements a true F_{min} is calculated. Refer to the noise parameter application section for more information.
2. S and noise parameters are measured on a microstrip line made on 0.025 inch thick alumina carrier. The input reference plane is at the end of the gate lead. The output reference plane is at the end of the drain lead.

ATF-53189 Typical Scattering and Noise Parameters at 25°C, $V_{DS} = 4.0V$, $I_{DS} = 75\text{ mA}$

Freq. GHz	S_{11}			S_{21}			S_{12}		S_{22}		MSG/MAG dB
	Mag.	Ang.	dB	Mag.	Ang.	dB	Mag.	Ang.	Mag.	Ang.	
0.1	0.926	-80.9	33.5	47.17	135.8	-35.9	0.016	51.6	0.389	-96	34.7
0.2	0.891	-121.5	29.9	31.192	114.3	-33.2	0.022	34.6	0.447	-131.4	31.5
0.3	0.882	-142.5	27.0	22.457	102.7	-32.0	0.025	26.7	0.471	-147.6	29.5
0.4	0.879	-155.4	24.8	17.36	94.8	-31.7	0.026	22.2	0.482	-157	28.2
0.5	0.885	-169.7	21.7	12.12	88.9	-32.8	0.023	19.7	0.551	-172.5	27.2
0.6	0.886	-175.4	20.1	10.145	85	-32.4	0.024	19	0.555	-176	26.3
0.7	0.886	-180	18.8	8.743	81.6	-32.4	0.024	18.6	0.557	-178.8	25.6
0.8	0.886	176.1	17.7	7.695	78.4	-32.0	0.025	18.5	0.557	178.7	24.9
0.9	0.885	172.5	16.8	6.883	75.3	-31.7	0.026	18.4	0.555	176.5	24.2
1.0	0.887	169.3	15.9	6.209	72.4	-31.7	0.026	18.3	0.554	174.4	23.8
1.5	0.884	155.1	12.5	4.212	58.8	-30.5	0.03	17.8	0.548	165.1	21.5
2.0	0.884	142.1	10.1	3.21	45.7	-29.1	0.035	15.6	0.538	156.3	19.2
2.5	0.88	129.1	8.4	2.618	32.5	-28.0	0.04	11.2	0.532	147.4	16.2
3.0	0.875	115.5	7.0	2.246	18.9	-27.1	0.044	4.9	0.532	139	14.4
3.5	0.882	106.2	6.1	2.018	8.1	-26.7	0.046	-1.1	0.549	130.5	13.8
4.0	0.889	96.8	5.1	1.791	-2.8	-26.6	0.047	-7.1	0.567	122	13.0
5.0	0.903	78.1	2.5	1.337	-24.5	-26.0	0.05	-19	0.603	105.1	11.1
6.0	0.917	59.4	-1.1	0.882	-46.2	-25.5	0.053	-31	0.638	88.1	8.2
7.0	0.947	43.5	-3.6	0.658	-65.5	-26.2	0.049	-42.2	0.681	75.1	7.9
8.0	0.959	31.7	-6.0	0.501	-83.3	-26.7	0.046	-53.9	0.725	61.6	7.2
9.0	0.941	23.4	-8.6	0.37	-98.9	-28.4	0.038	-65.8	0.77	48.2	4.0
10.0	0.946	14.1	-10.7	0.292	-114.3	-29.6	0.033	-82.9	0.805	36.9	3.3
11.0	0.936	3.1	-12.5	0.236	-131.4	-33.2	0.022	-116.4	0.826	27.2	1.7
12.0	0.914	-3.7	-14.2	0.194	-146	-37.7	0.013	-159.1	0.843	17.2	-0.7
13.0	0.951	-14.9	-16.2	0.154	-166.9	-37.7	0.013	104.3	0.843	8	-0.3
14.0	0.948	-19.8	-18.3	0.121	-175.3	-39.2	0.011	56.9	0.85	1.2	-2.9
15.0	0.937	-21.1	-19.0	0.112	176.1	-40.9	0.009	79.5	0.877	-4.2	-3.5
16.0	0.949	-24.5	-19.7	0.104	167.9	-43.1	0.007	74.4	0.878	-8.2	-3.2
17.0	0.947	-32.9	-18.6	0.118	154.7	-37.7	0.013	117.9	0.887	-13.1	-1.6
18.0	0.906	-45.1	-17.8	0.129	138.1	-33.6	0.021	111.8	0.862	-21.1	-4.1

Freq GHz	Fmin dB	Gamma Opt		Rn/50	Ga dB
		Mag	Ang		
0.5	0.32	0.175	127.6	0.05	26.45
0.9	0.41	0.224	143.8	0.04	21.98
1.0	0.43	0.235	148.3	0.03	21.50
1.5	0.49	0.306	173.6	0.03	18.55
2.0	0.56	0.375	-163.6	0.03	16.33
2.4	0.61	0.428	-147.2	0.04	15.18
3.0	0.69	0.507	-125.3	0.08	13.86
3.5	0.75	0.569	-109.3	0.14	12.68
5.0	0.95	0.738	-72.0	0.20	10.81
5.8	1.05	0.814	-57.4	0.24	10.64
6.0	1.08	0.831	-54.2	0.24	9.97
7.0	1.21	0.907	-40.5	0.30	9.25
8.0	1.34	0.961	-29.3	0.60	7.78
9.0	1.47	0.992	-19.3	0.71	6.96
10.0	1.60	0.996	-8.9	1.01	4.46

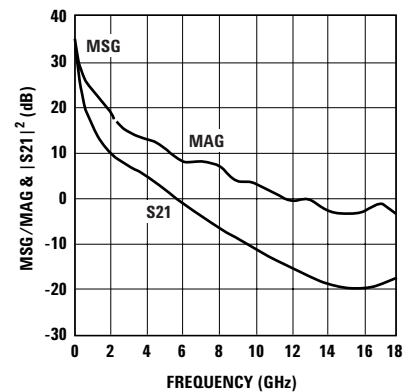

Figure 38. MSG/MAG & $|S_{21}|^2$ vs. and Frequency at 4.0V/75 mA.

Notes:

1. F_{min} values at 2 GHz and higher are based on measurements while the F_{min} below 2 GHz have been extrapolated. The F_{min} values are based on a set of 16 noise figure measurements made at 16 different impedances using an ATN NP5 test system. From these measurements a true F_{min} is calculated. Refer to the noise parameter application section for more information.
2. S and noise parameters are measured on a microstrip line made on 0.025 inch thick alumina carrier. The input reference plane is at the end of the gate lead. The output reference plane is at the end of the drain lead.

ATF-53189 Typical Scattering and Noise Parameters at 25°C, $V_{DS} = 5.0V$, $I_{DS} = 135$ mA

Freq. GHz	S_{11}			S_{21}			S_{12}		S_{22}		MSG/MAG dB
	Mag.	Ang.	dB	Mag.	Ang.	dB	Mag.	Ang.	Mag.	Ang.	
0.1	0.903	-47.8	32.5	42.048	152.7	-37.7	0.013	66.6	0.466	-39.6	35.1
0.2	0.889	-84.2	30.8	34.523	133.5	-33.2	0.022	49.3	0.432	-71.6	32.0
0.3	0.879	-109.8	28.9	27.96	119.5	-31.4	0.027	37.6	0.404	-94.7	30.2
0.4	0.874	-127.8	27.2	22.97	109.2	-30.8	0.029	29.8	0.385	-111.3	29.0
0.5	0.857	-151.5	24.6	17.06	98.2	-31.4	0.027	21.2	0.388	-146.6	28.0
0.6	0.856	-160	23.2	14.454	93.1	-31.1	0.028	18.5	0.389	-153.7	27.1
0.7	0.854	-166.6	22.0	12.541	88.7	-31.1	0.028	16.7	0.39	-158.9	26.5
0.8	0.853	-172	20.9	11.079	84.9	-30.8	0.029	15.4	0.388	-163.2	25.8
0.9	0.852	-176.7	19.9	9.935	81.4	-30.8	0.029	14.3	0.386	-166.6	25.3
1.0	0.854	179.1	19.1	8.984	78.1	-30.5	0.03	13.6	0.383	-169.5	24.8
1.5	0.852	162	15.7	6.117	63.7	-29.9	0.032	11	0.373	179.1	22.8
2.0	0.851	147.6	13.4	4.662	50.4	-29.4	0.034	8.7	0.361	170.2	21.4
2.5	0.846	133.8	11.6	3.798	37.4	-28.6	0.037	5.3	0.352	161.7	18.8
3.0	0.844	119.8	10.3	3.257	24.2	-28.0	0.04	0.6	0.35	153.9	16.8
3.5	0.854	110	9.3	2.934	13.4	-27.7	0.041	-4.1	0.371	145.2	16.1
4.0	0.864	100.1	8.3	2.611	2.5	-27.5	0.042	-8.8	0.392	136.6	15.3
5.0	0.883	80.3	5.9	1.965	-19.1	-26.9	0.045	-18.3	0.433	119.2	13.3
6.0	0.903	60.6	2.4	1.319	-40.8	-26.6	0.047	-27.7	0.475	101.9	10.5
7.0	0.939	44	-0.1	0.989	-60.9	-27.1	0.044	-37.9	0.536	88.4	10.2
8.0	0.957	31.7	-2.4	0.756	-79.4	-27.7	0.041	-49	0.601	73.8	9.8
9.0	0.941	23	-5.0	0.562	-96.1	-29.1	0.035	-61.5	0.666	58.9	6.5
10.0	0.948	13.6	-7.1	0.441	-112	-30.8	0.029	-79.3	0.72	46.2	5.8
11.0	0.941	2.5	-9.0	0.353	-129.2	-34.0	0.02	-117.6	0.757	35.7	4.4
12.0	0.919	-4.4	-10.8	0.29	-143.9	-38.4	0.012	-172.8	0.785	25.2	1.9
13.0	0.958	-15.5	-12.7	0.231	-163.8	-34.9	0.018	105.3	0.796	15.4	3.1
14.0	0.951	-20.1	-14.8	0.183	-174.6	-35.4	0.017	74.4	0.814	7.9	0.2
15.0	0.942	-21.1	-15.9	0.16	175.9	-35.4	0.017	84	0.849	1.6	-0.8
16.0	0.956	-24.2	-16.7	0.147	166	-34.0	0.02	81.8	0.855	-2.7	-0.2
17.0	0.957	-31.9	-16.5	0.149	152.8	-31.4	0.027	87	0.868	-7.7	0.7
18.0	0.917	-43.6	-16.1	0.156	134.6	-28.4	0.038	77.6	0.851	-14.6	-2.5

Freq GHz	Fmin dB	Gamma Opt		Rn/50	Ga dB
		Mag	Ang		
0.5	0.36	0.266	149.9	0.05	26.51
0.9	0.46	0.315	162.4	0.04	22.79
1.0	0.49	0.327	165.6	0.04	22.09
1.5	0.59	0.388	-172.7	0.04	18.92
2.0	0.69	0.448	-153.0	0.04	17.04
2.4	0.77	0.495	-138.6	0.06	15.87
3.0	0.88	0.563	-116.3	0.12	14.50
3.5	0.98	0.617	-104.9	0.21	13.11
5.0	1.28	0.764	-70.5	0.31	11.19
5.8	1.44	0.830	-56.5	0.37	10.10
6.0	1.48	0.845	-53.4	0.38	10.08
7.0	1.68	0.912	-39.7	0.42	9.39
8.0	1.88	0.960	-28.3	0.84	8.78
9.0	2.08	0.988	-18.3	1.24	8.05
10.0	2.28	0.994	-8.5	1.78	4.74

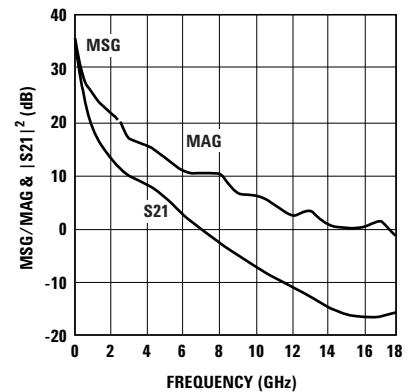

Figure 39. MSG/MAG & $|S_{21}|^2$ vs. and Frequency at 5.0V/135 mA.

Notes:

1. F_{min} values at 2 GHz and higher are based on measurements while the F_{min} below 2 GHz have been extrapolated. The F_{min} values are based on a set of 16 noise figure measurements made at 16 different impedances using an ATN NP5 test system. From these measurements a true F_{min} is calculated. Refer to the noise parameter application section for more information.
2. S and noise parameters are measured on a microstrip line made on 0.025 inch thick alumina carrier. The input reference plane is at the end of the gate lead. The output reference plane is at the end of the drain lead.

ATF-53189 Typical Scattering and Noise Parameters at 25°C, $V_{DS} = 3.0V$, $I_{DS} = 135\text{ mA}$

Freq. GHz	S_{11}			S_{21}			S_{12}		S_{22}		MSG/MAG dB
	Mag.	Ang.	dB	Mag.	Ang.	dB	Mag.	Ang.	Mag.	Ang.	
0.1	0.925	-47.5	32.6	42.873	152.7	-37.7	0.013	66.6	0.435	-44	35.2
0.2	0.904	-83.8	30.9	35.157	133.4	-33.2	0.022	49.4	0.425	-78.6	32.0
0.3	0.889	-109.3	29.1	28.44	119.5	-31.4	0.027	37.7	0.416	-102.6	30.2
0.4	0.882	-127.4	27.4	23.35	109.2	-30.5	0.03	29.8	0.41	-119.1	28.9
0.5	0.861	-151.3	24.7	17.223	98.3	-31.1	0.028	21.4	0.433	-151.6	27.9
0.6	0.859	-159.8	23.3	14.586	93.2	-31.1	0.028	18.7	0.437	-158.2	27.2
0.7	0.856	-166.5	22.0	12.655	88.9	-30.8	0.029	17	0.439	-163	26.4
0.8	0.855	-171.8	21.0	11.183	85.2	-30.8	0.029	15.7	0.438	-167.1	25.9
0.9	0.853	-176.7	20.0	10.027	81.7	-30.5	0.03	14.8	0.436	-170.4	25.2
1.0	0.855	179.1	19.1	9.067	78.4	-30.5	0.03	14	0.435	-173.3	24.8
1.5	0.851	162.1	15.8	6.179	64.3	-29.6	0.033	11.4	0.425	175.3	22.7
2.0	0.851	147.6	13.5	4.713	51.2	-29.1	0.035	8.9	0.413	166	21.3
2.5	0.845	133.8	11.7	3.846	38.4	-28.2	0.039	5	0.403	157.1	19.6
3.0	0.843	119.8	10.4	3.299	25.4	-27.5	0.042	-0.1	0.401	148.8	17.0
3.5	0.853	110	9.5	2.972	14.8	-27.3	0.043	-5.1	0.419	140.2	16.3
4.0	0.862	100.1	8.4	2.645	4.1	-27.1	0.044	-10.2	0.438	131.6	15.4
5.0	0.882	80.4	6.0	1.99	-17.1	-26.7	0.046	-20.2	0.475	114.3	13.4
6.0	0.901	60.7	2.5	1.336	-38.4	-26.4	0.048	-30.3	0.512	97.1	10.5
7.0	0.938	44.1	0.1	1.006	-58	-27.1	0.044	-40.8	0.565	84	10.3
8.0	0.955	31.8	-2.3	0.771	-76	-27.7	0.041	-51.6	0.622	70	9.7
9.0	0.938	23.1	-4.8	0.576	-92.2	-29.4	0.034	-64	0.681	55.7	6.5
10.0	0.946	13.6	-6.9	0.453	-107.4	-30.8	0.029	-82	0.729	43.6	5.8
11.0	0.94	2.6	-8.8	0.364	-124.6	-34.0	0.02	-121.6	0.76	33.5	4.6
12.0	0.92	-4.2	-10.4	0.302	-138.3	-37.7	0.013	-176.6	0.785	23.3	2.3
13.0	0.958	-15.5	-12.4	0.241	-157.7	-34.9	0.018	105.2	0.794	13.8	3.6
14.0	0.952	-20.1	-14.4	0.191	-167.9	-35.4	0.017	74.2	0.81	6.6	0.7
15.0	0.943	-21.2	-15.5	0.167	-177	-35.4	0.017	85.1	0.844	0.5	-0.3
16.0	0.955	-24.2	-16.2	0.154	173.2	-34.0	0.02	83.1	0.849	-3.7	0.1
17.0	0.958	-31.9	-16.0	0.159	159.5	-31.4	0.027	89	0.861	-8.5	1.5
18.0	0.918	-43.5	-15.7	0.165	141.4	-28.4	0.038	79.5	0.843	-15.5	-2.0

Freq GHz	Fmin dB	Gamma Opt		Rn/50	Ga dB
		Mag	Ang		
0.5	0.34	0.225	146.2	0.05	26.30
0.9	0.43	0.282	157.0	0.04	22.19
1.0	0.45	0.296	160.2	0.04	22.07
1.5	0.53	0.362	-177.0	0.03	19.00
2.0	0.61	0.427	-156.3	0.03	17.13
2.4	0.68	0.478	-141.3	0.05	15.89
3.0	0.78	0.551	-121.1	0.09	14.59
3.5	0.86	0.608	-106.2	0.17	13.17
5.0	1.10	0.763	-70.8	0.24	11.22
5.8	1.24	0.832	-56.6	0.28	10.16
6.0	1.27	0.848	-53.5	0.30	9.93
7.0	1.43	0.915	-39.7	0.38	9.57
8.0	1.60	0.964	-28.4	0.74	8.78
9.0	1.76	0.991	-18.5	0.95	7.27
10.0	1.93	0.995	-8.6	1.55	3.39

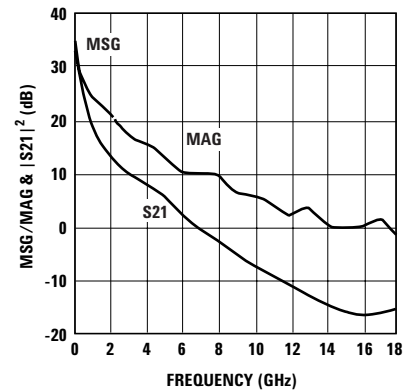

Figure 40. MSG/MAG & $|S_{21}|^2$ vs. and Frequency at 3.0V/135 mA.

Notes:

1. F_{min} values at 2 GHz and higher are based on measurements while the F_{min} below 2 GHz have been extrapolated. The F_{min} values are based on a set of 16 noise figure measurements made at 16 different impedances using an ATN NP5 test system. From these measurements a true F_{min} is calculated. Refer to the noise parameter application section for more information.
2. S and noise parameters are measured on a microstrip line made on a 0.025 inch thick alumina carrier. The input reference plane is at the end of the gate lead. The output reference plane is at the end of the drain lead.

Device Models, PCB Layout and Stencil Device

Refer to Avago's Web Site: http://www.avagotech.com/pages/en/rf_microwave

Ordering Information

Part Number	No. of Devices	Container
ATF-53189-TR1	3000	13" Reel
ATF-53189-BLK	100	Anti-static bag

SOT89 Package Dimensions

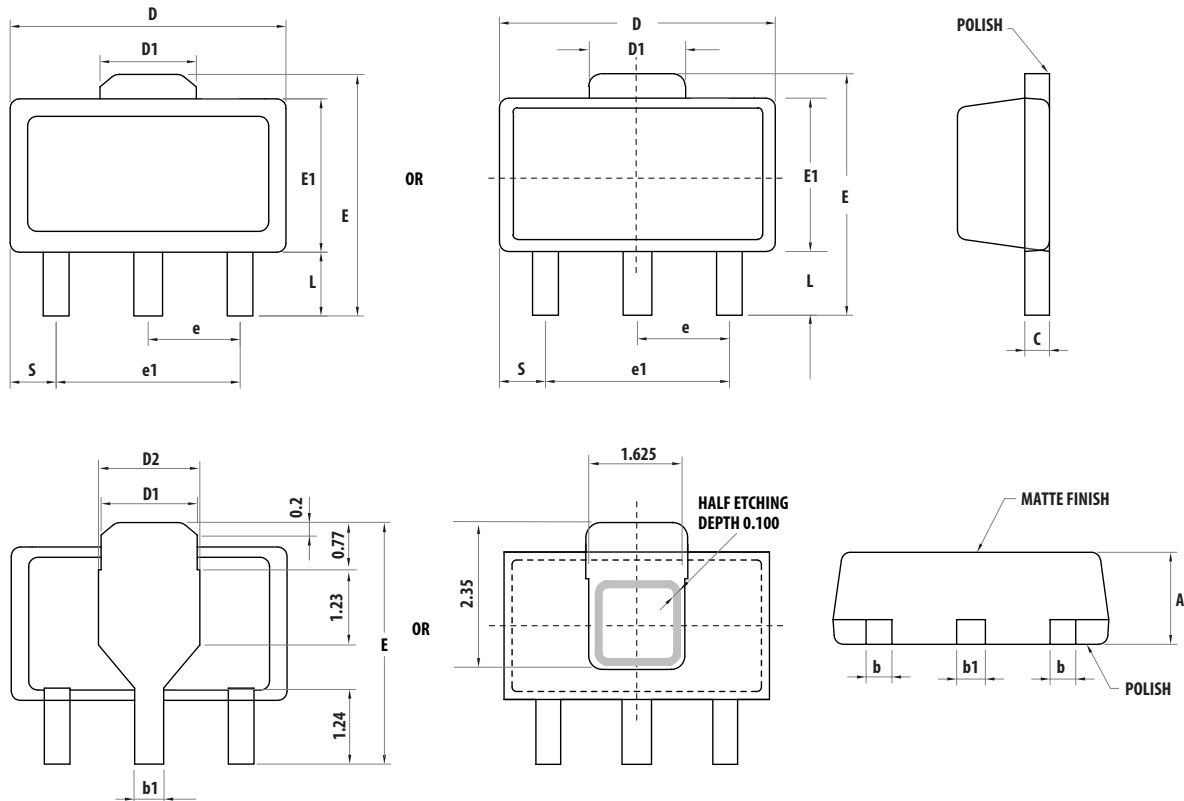

Symbols	Dimensions in mm			Dimensions in inches		
	Minimum	Nominal	Maximum	Minimum	Nominal	Maximum
A	1.40	1.50	1.60	0.055	0.059	0.063
L	0.89	1.04	1.20	0.0350	0.041	0.047
b	0.36	0.42	0.48	0.014	0.016	0.018
b1	0.41	0.47	0.53	0.016	0.018	0.030
C	0.38	0.40	0.43	0.014	0.015	0.017
D	4.40	4.50	4.60	0.173	0.177	0.181
D1	1.40	1.60	1.75	0.055	0.062	0.069
D2	1.45	1.65	1.80	0.055	0.062	0.069
E	3.94	-	4.25	0.155	-	0.167
E1	2.40	2.50	2.60	0.094	0.098	0.102
e1	2.90	3.00	3.10	0.114	0.118	0.122
S	0.65	0.75	0.85	0.026	0.030	0.034
e	1.40	1.50	1.60	0.054	0.059	0.063

Device Orientation

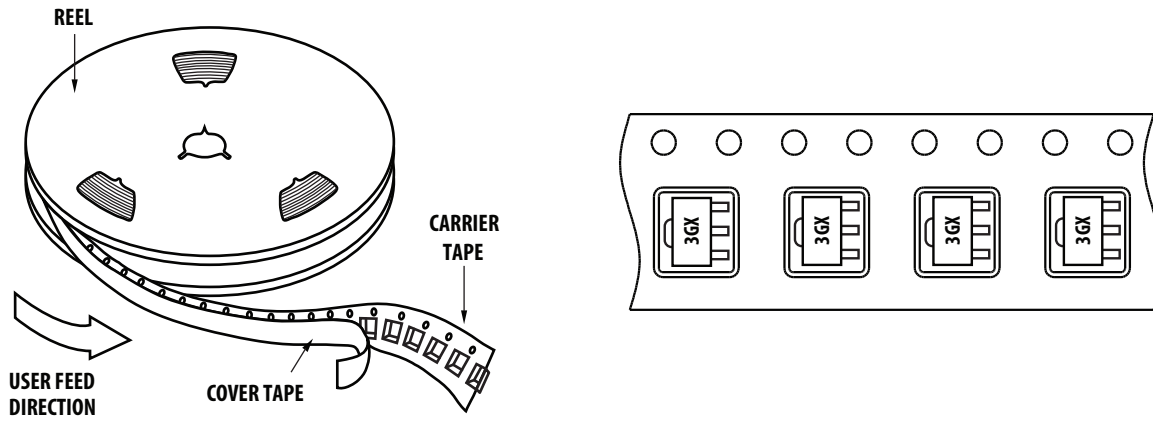

Tape Dimensions

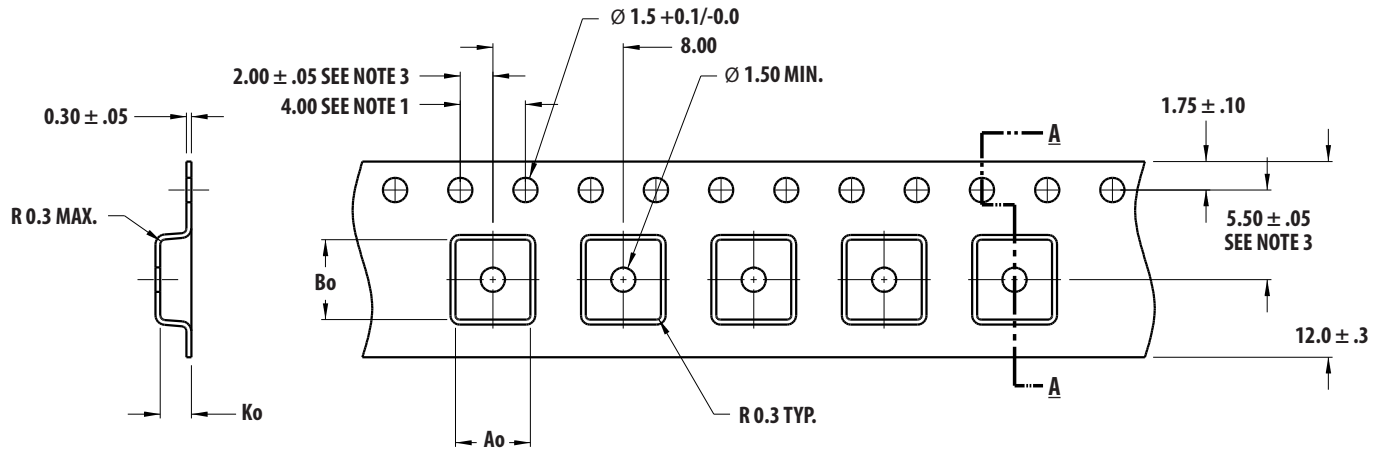

Ao = 4.60
Bo = 4.90
Ko = 1.90

DIMENSIONS IN MM

NOTES:

1. 10 SPROCKET HOLE PITCH CUMULATIVE TOLERANCE ± 0.2
2. CAMBER IN COMPLIANCE WITH EIA 481
3. POCKET POSITION RELATIVE TO SPROCKET HOLE MEASURED AS TRUE POSITION OF POCKET, NOT POCKET HOLE

