

**891-008 and -009**  
**Series 89 Nanominiature Connectors**  
**Double Row Thru Hole Right Angle Printed Circuit Board**

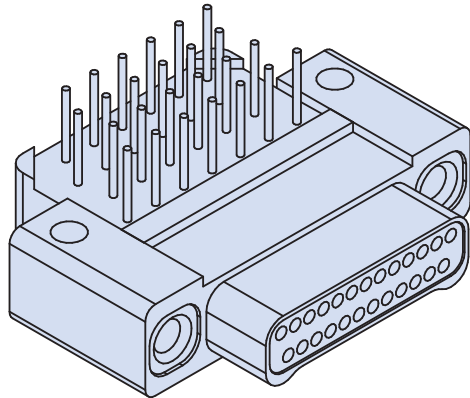

Double Row Connectors



**Right Angle Mount PCB Nano Connectors** feature gold alloy TwistPin contacts. These nanominiature connectors offer premium performance and reliability for demanding applications. Available with #0-80 female threads, or with jackscrews for use with flexible circuits.

**Pre-Tinned PC Tails** are coated with Sn63Pb37 tin-lead for excellent solderability.

**Choose Aluminum, Titanium or Stainless Steel Shells** in seven layouts from 9 to 51 contacts. Complies to the requirements of MIL-DTL-32139. These connectors are intermateable with any corresponding Glenair Series 891 Double row metal shell nanominiature connector.

**HOW TO ORDER RIGHT ANGLE MOUNT PCB CONNECTORS**

Series	Insert Arrangement/ Contact Type	Shell Material and Finish	Termination Type	PC Tail Length	Hardware
<b>891-008</b> Plug, Pin Contacts, Double Row, Right Angle PCB Nanominiature	Plugs (891-008) <b>9P</b> <b>15P</b> <b>21P</b> <b>25P</b> <b>31P</b> <b>37P</b> <b>51P</b>	<b>A1</b> Aluminum Shell, Cadmium Plating	<b>BRT</b> "Board Right Angle Thru-Hole"	<b>1</b> .110 Inch (2.79 mm)	<b>J</b> Jackscrew, #0-80
		<b>A2</b> Aluminum Shell, Electroless Nickel Plating		<b>2</b> .172 Inch (4.37 mm)	<b>T</b> #0-80 Female Thread
		<b>T</b> Titanium Shell, Unplated			
		<b>S</b> Stainless Steel Shell, Passivated			
<b>891-009</b> Receptacle, Socket Contacts, Double Row, Right Angle PCB Nanominiature	Receptacles (891-009) <b>9S</b> <b>15S</b> <b>21S</b> <b>25S</b> <b>31S</b> <b>37S</b> <b>51S</b>				
<b>Sample Part Number</b>					
<b>891-009</b>	<b>— 31S</b>	<b>T</b>	<b>—BRT</b>	<b>1</b>	<b>T</b>

**MATERIALS AND FINISHES**

Connector Shell	See Ordering Information
Insulator	Liquid Crystal Polymer (LCP), 30% Glass-Filled
Contacts	Gold Alloy, Unplated
Hardware	300 Series Stainless Steel
PC Tails	#30 (.010 Dia.) Copper Wire, Solder Dipped
PCB Trays	Liquid Crystal Polymer (LCP) or Epoxy
Encapsulant	Epoxy

**SPECIFICATIONS**

Durability	200 Cycles Minimum
Current Rating	1 AMP Maximum
Voltage Rating (DWV)	300 VAC RMS Sea Level
Insulation Resistance	5000 Megohms Minimum
Operating Temperature	-55° C. to +125° C.
Contact Resistance	71 mV. @1 AMP #30 AWG Wire
Thermal Vacuum Outgassing	1.0% Max TML, 0.1% Max.

DOUBLE ROW RIGHT ANGLE PCB NANO DIMENSIONS

Plug (Pin) Connectors

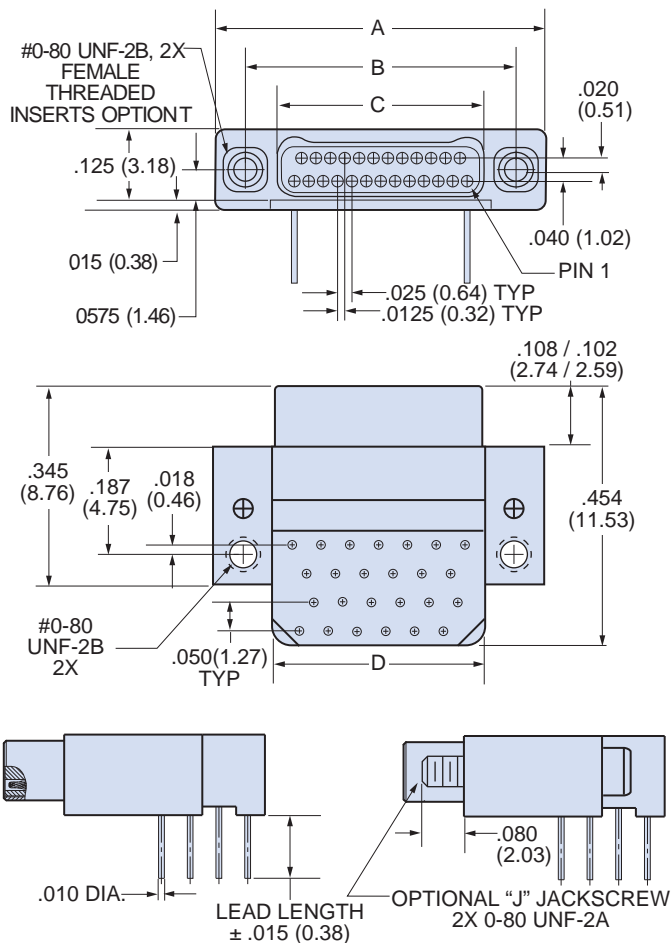

Receptacle (Socket) Connectors

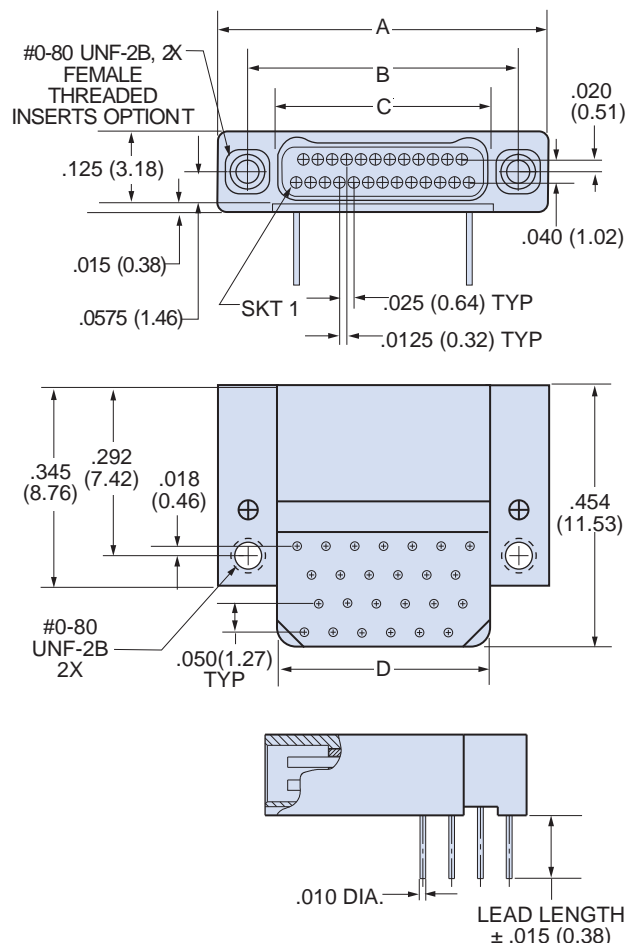

Layout	A		B BSC.		C BSC.		D	
	In. ± .005	mm. ± 0.13	In.	mm.	In.	mm.	In. ± .005	mm. ± 0.13
9P	.375	9.52	.270	6.86	.160	4.06	.170	4.32
9S	.375	9.52	.270	6.86	.163	4.14	.170	4.32
15P	.450	11.43	.345	8.76	.235	5.97	.245	6.22
15S	.450	11.43	.345	8.76	.238	6.04	.245	6.22
21P	.525	13.33	.420	10.67	.310	7.87	.320	8.13
21S	.525	13.33	.420	10.67	.313	7.95	.320	8.13
25P	.575	14.60	.470	11.94	.360	9.14	.370	9.40
25S	.575	14.60	.470	11.94	.363	9.22	.370	9.40
31P	.650	16.51	.545	13.84	.435	11.05	.445	11.30
31S	.650	16.51	.545	13.84	.438	11.12	.445	11.30
37P	.725	18.41	.620	15.75	.510	12.95	.520	13.21
37S	.725	18.41	.620	15.75	.513	13.03	.520	13.21
51P	.900	22.86	.795	20.19	.685	17.40	.695	17.65
51S	.900	22.86	.795	20.19	.688	17.47	.695	17.65

# 891-008 and -009 Series 89 Nanominiature Connectors Double Row Thru Hole Right Angle Printed Circuit Board



Double Row  
Connectors

Patterns shown are for connector mounting side of PC Board.

## RIGHT ANGLE PCB PLUG (PIN) CONNECTOR LAYOUT 891-008

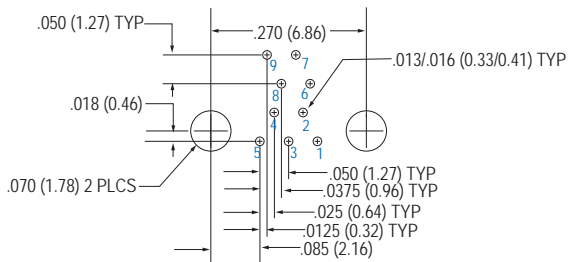
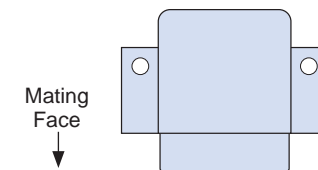
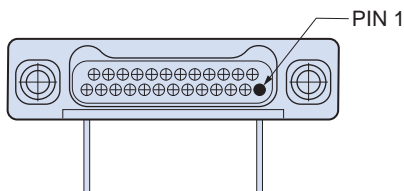

**9 Contacts**

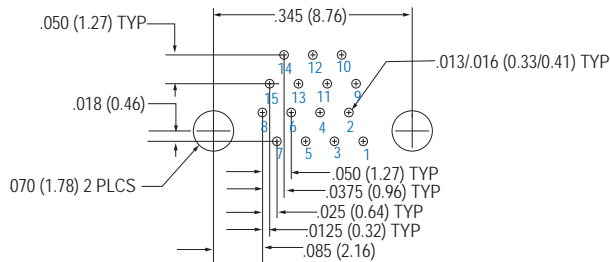

**15 Contacts**

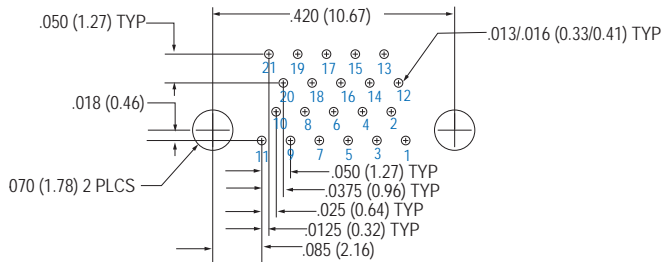

**21 Contacts**

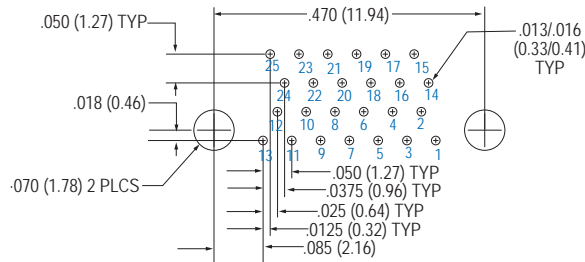

**25 Contacts**

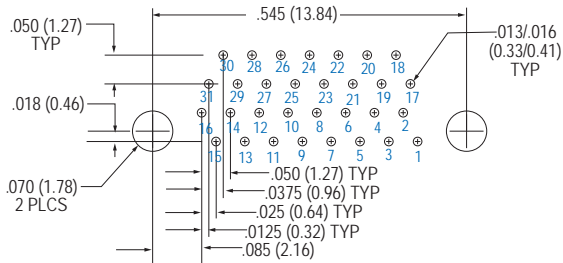

**31 Contacts**

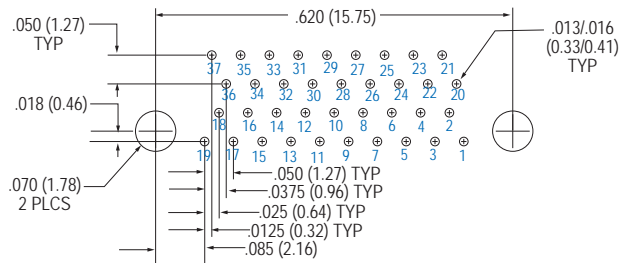

**37 Contacts**

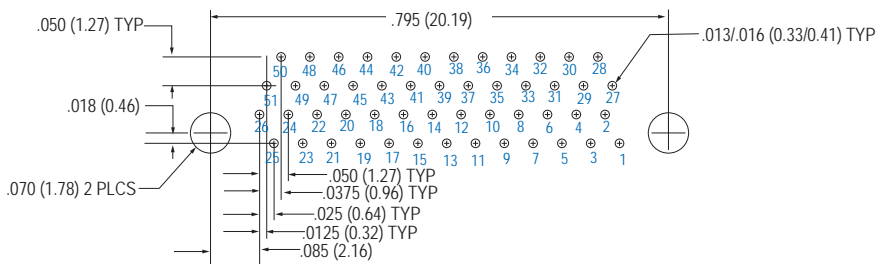

**51 Contacts**

Patterns shown are for connector mounting side of PC Board.

**RIGHT ANGLE PCB RECEPTACLE (SOCKET) CONNECTOR LAYOUT 891-009**

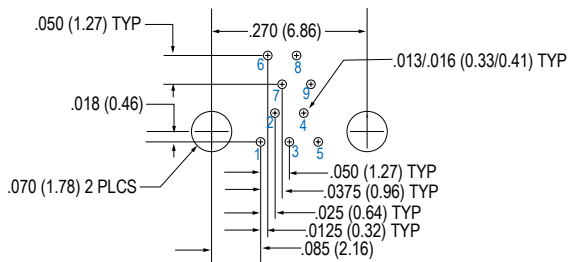
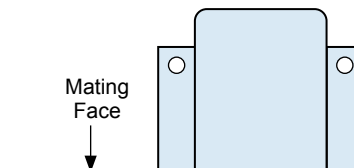
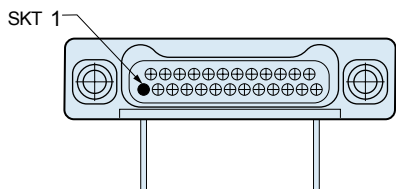

**9 Contacts**

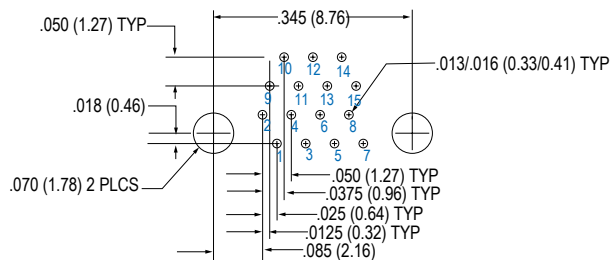

**15 Contacts**

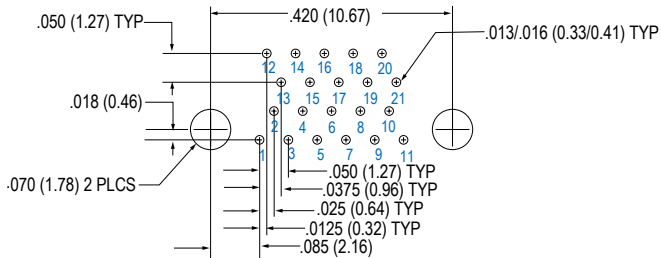

**21 Contacts**

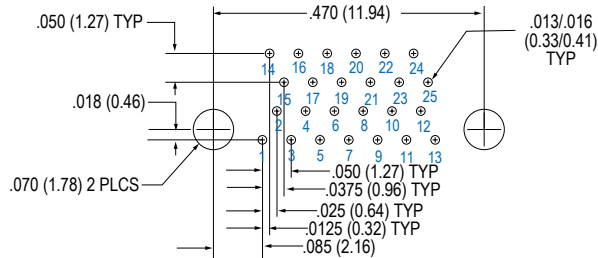

**25 Contacts**

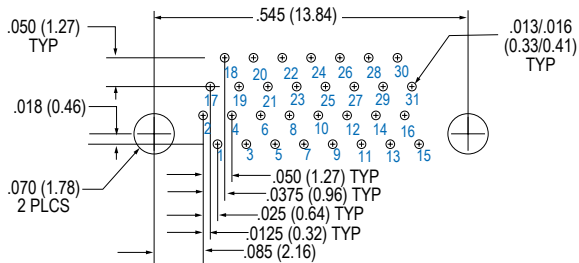

**31 Contacts**

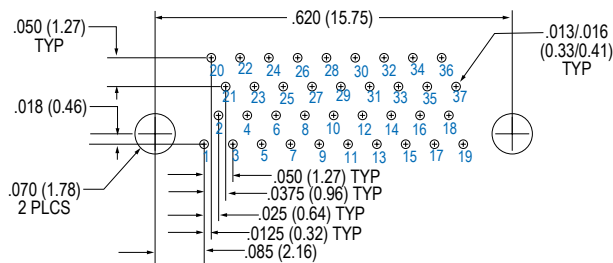

**37 Contacts**

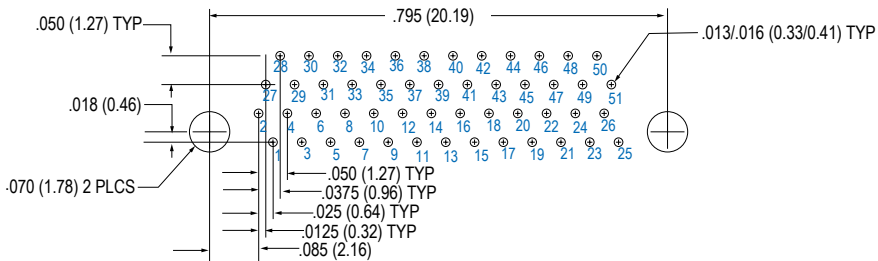

**51 Contacts**