

## **KYL-300M RF Data Radio Module**



### **Shenzhen KYL Communication Equipment Co., Ltd**

**Address:** Unit 5-7, Building3, Huangdu Square, South of Exhibition Center, Yitian Road, Futian District, Shenzhen Guangdong China

**Tel:** +86-0755-83410815

**Fax:** +86-0755-83408785

**Skype:** lxmlosia

**Yahoo messenger:** losia2012

**MSN:** kylcom01.com@hotmail.com

**E\_mail:** sales01@rf-data.com/kyl03losia@gmail.com

**Website:** <http://www.rf-data.com>

## **Catalogue**

<b>I. About KYL-300M .....</b>	<b>3</b>
<b>II. Features of KYL-300M .....</b>	<b>3</b>
<b>III. Applications of KYL-300M.....</b>	<b>4</b>
<b>IV. How to use KYL-300M.....</b>	<b>4</b>
<b>V. Networking Application of KYL-300M.....</b>	<b>13</b>
<b>VI. Technical specification of KYL-300M.....</b>	<b>13</b>
<b>VII. Description of type.....</b>	<b>14</b>

Before using the product please read the use manual carefully.

Any question in technical, you can contact us.

Tel: +86-755-83410815.

## **I: About KYL-300M**

KYL-300M, RF data radio is designed to be low cost and high performance radio modem. The new design makes the modem more flexible for different application in various configurations. Basically, this type of modem is SMART enough to be customized to best meet end user's requirements. Users don't have to pay the features that never be used in their projects.

## **II: Features:**

### **I. Features of KYL-300M**

1. Low power transmission with 2W.
2. With 433MHz as factory default carrier frequency, 400~470MHz is available if needed.
3. High anti- interference and Low BER (Bit error Rate)  
Based on the Gaussian Frequency Shift Keying (GFSK) modulation, the high-efficiency forward error correction channel encoding technology is used to enhance data's resistance to both transient interference and random interference and the actual bit error rate of  $10^{-5} \sim 10^{-6}$  can be achieved when channel bit error rate is  $10^{-2}$ .
4. Long Transmission Distance  
Within the visible range, when the height of antenna is higher than 2m and The Bit Error Rate (BER) is  $10^{-3}$ , the reliable transmission distances respectively is 7000m @1200bps, and is 5000m@9600bps.
5. Transparent data transmission  
Transparent data interface used in transceivers is for meeting many standard or nonstandard user protocols. Any false data generated in air can be filtrated automatically (What has been received is exactly what has been transmitted).
6. Multi-channels  
KYL-300M transceivers offer 8 channels, if needed, 16 or 32 channels are available to satisfy various configuration of communication under user's demand at the same time.
7. 2 ports with three connection methods  
KYL-300M transceivers provide 2 ports with three connections, ports: a UART interface of TTL level, a non-standard RS-232 port and a non-standard RS-485 port. USB interface port is also available if needed.
8. Big data buffer area  
With optional interface baud rate: 1200/4800/9600/19200bps and 8N1/8E1/8O1 data format (set by user), the transceiver can transmit unlimited data frames with flexible user program.

Note: the RF data rate is only settled down before delivery, please inform our sales

- when placing your orders.
9. Intelligent data control and no any extra programs required  
Even for half duplex communication, no any excessive programs required. All RF system data transmission/reception and other On-the-Fly conversion and control are performed by KYL-300M transceivers automatically.
  10. Lower power consumption & Sleep function  
With +5V power, the receiving current is less than 30mA, the transmitting current is less than 1.5A, and the sleeping current is less than 20uA.
  11. High reliability, small and light  
By using monolithic radio-frequency integrated circuit and single-chip MCU, the transceivers have less peripheral circuit s, high reliability, and low failure rate.
  12. More options of configurable antennas for user different applications.
  13. Watchdog monitor  
Watchdog monitors the inner function, so it can change the traditional product structure and also improve the reliability of our modules.
  14. With beautiful metal shell.

### **III: Application of KYL-300M:**

KYL-300M RF data radio is suitable for:

- \* AMR Automatic Meter Reading
- \* Wireless alarm and security systems
- \* Building automation, security, wireless monitoring and control of room equipment, Access Control System;
- \* Wireless data transmission, automatic data collection system;
- \* Radio modem can be used for Sports training & competition;
- \* Wireless dishes ordering;
- \* Wireless POS, PDA wireless smart terminal;
- \* RF modem can be used for Electronic bus station and intelligent traffic;
- \* RF transmitter Wireless electronic display screen and queuing machine;
- \* Wireless telemetry Charging for parking, parking lot;
- \* Wireless modem Automobile inspection and four-wheel orientation;
- \* Wireless sensor Industrial wireless remote control and air conditioning remote controller;
- \* Data communication used for railway, oil field, dock and army.
- \* LED display in thruway and public places
- \* Point to multi-point wireless network, wireless on-the-spot bus and automatic data collection system;

### **IV: How to use the KYL-300M**

KYL-300M provide RS-232, RS-485 and UART/TTL level interface port for direct connection with PC, RS485 devices, monolithic processors and other UART components kinds of applications. The schematic diagram is shown below:

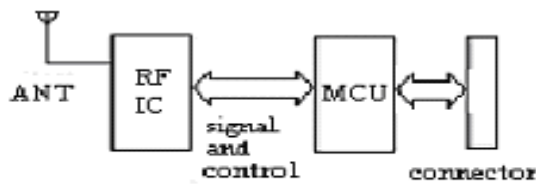

KYL-300M Principle map

**1. Power supply**

The factory default setting is +5V(7.5V-12V will inform when placing the order).By using better ripple factor, KYL-300M transceivers can also share power supply with other equipment. If possible, a voltage-stabilizing chip with 5V voltage is more recommended as the only power supply than Switch power supply. But if only switch power supply available, the jam by switch pulse to the transceivers should be avoided. In addition, the reliable grounding must be used if there is other device in the system equipment. In case of failing to connect with the ground, it can form its own grounding but must be absolutely separated from the municipal electric supply.

**2. Connection Definition with terminal**

KYL-300M transceivers supply one 9-pin connector (JP1), their definitions and connection methods with terminals are shown in Table 1.

**Table 1: JP1 Pin Definitions and connection methods**

Pin No.	Signal Name	Function	Level	Connection with terminal	Remarks
1	GND	Grounding of power supply		Ground	
2	Vcc	Power supply DC	5V		
3	RxD/TTL	Serial data input to the transceiver	TTL	TxD	
4	TxD/TTL	Transmitted data out of the transceiver	TTL	RxD	
5	SGND	Signal			
6	A (TXD)	A of RS-485(TxD of RS-232)		A(RxD)	
7	B (RXD)	B of RS-485(RxD of RS-232)		B(TxD)	
8	SLEEP	Sleep control (input)	TTL	Sleep signal	High level sleep
9	RESET	Reset signal(input)	TTL		Negative pulse reset

**3. The connection schematic diagram between computer and our**

**RF module**

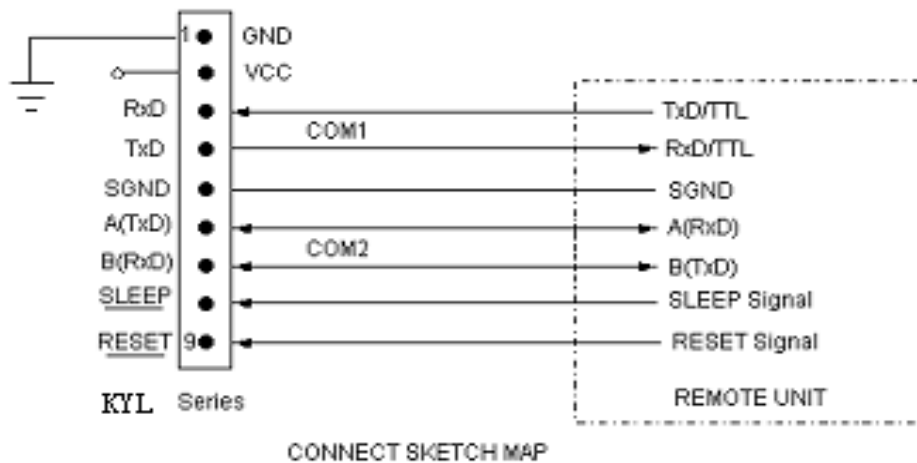

**4. Setting of channel, interface, and data format**

Before using KYL-300M, the user needs to make simple configuration based on its own needs to determine the channel, interface mode and data format. The user can change or view the module's interface baud rate, channel and address code. Parameter setting or reading as per the testing software KYLCOM in the PC (in products box). And the configuration is as follows:

i. Channel configuration:

Channel No.	Frequency	Channel No.	Frequency
1	429.0325MHZ	5	433.0325MHZ
2	430.0325MHZ	6	434.0325MHZ
3	431.0325MHZ	7	435.0325MHZ
4	432.0325MHZ	8	436.0325MHZ

**Note: the frequency points corresponding to each channel can be adjusted based on the user's needs.**

ii. The schematic diagram of setting the parameter as follows:

- a. Connect the PC and module with RS232 data cable.
- b. Open the “KYLCOM” PC software, select “English” as follows:



c. Click “open port”, then will open a small window as the following picture, clients will write the parameters in this windows.

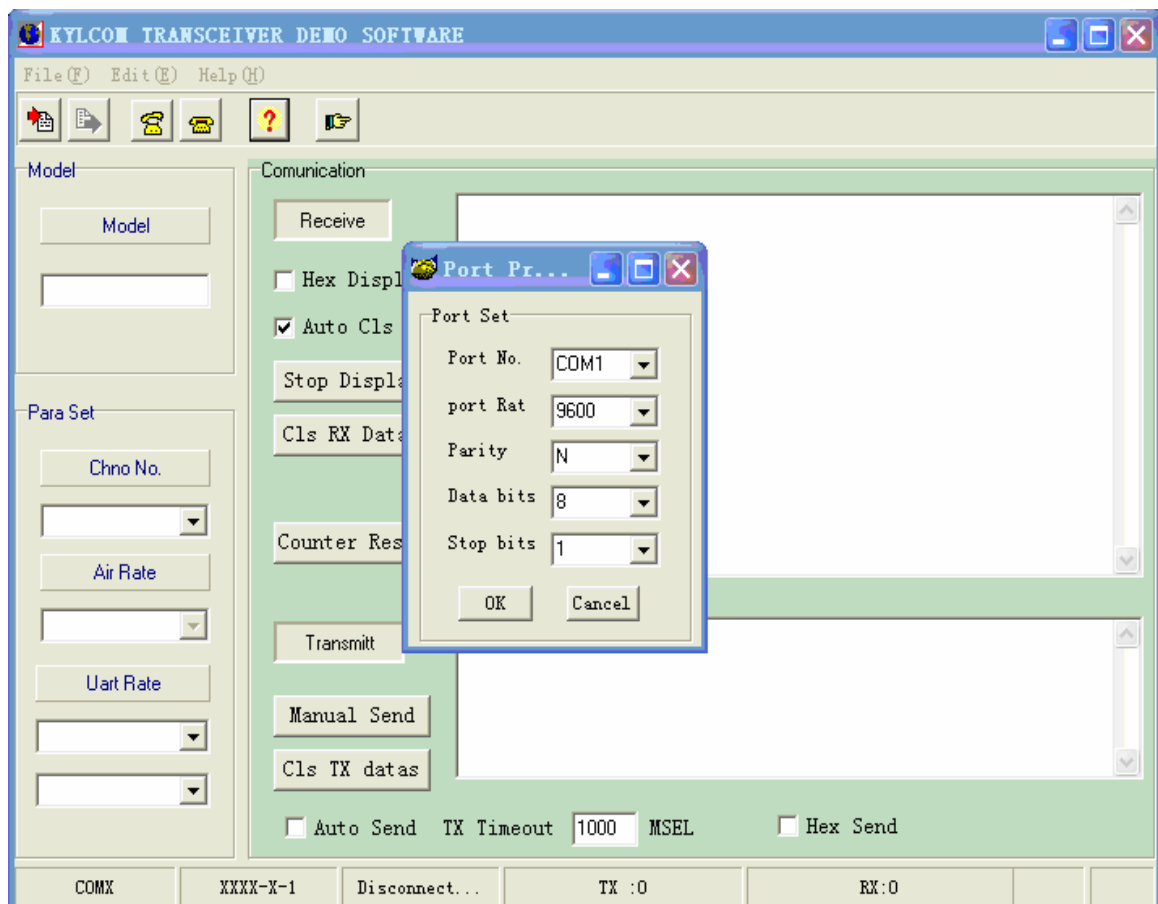

d. Click “read paras”.

“Read correct” show your connection between KYL module and PC is correct.

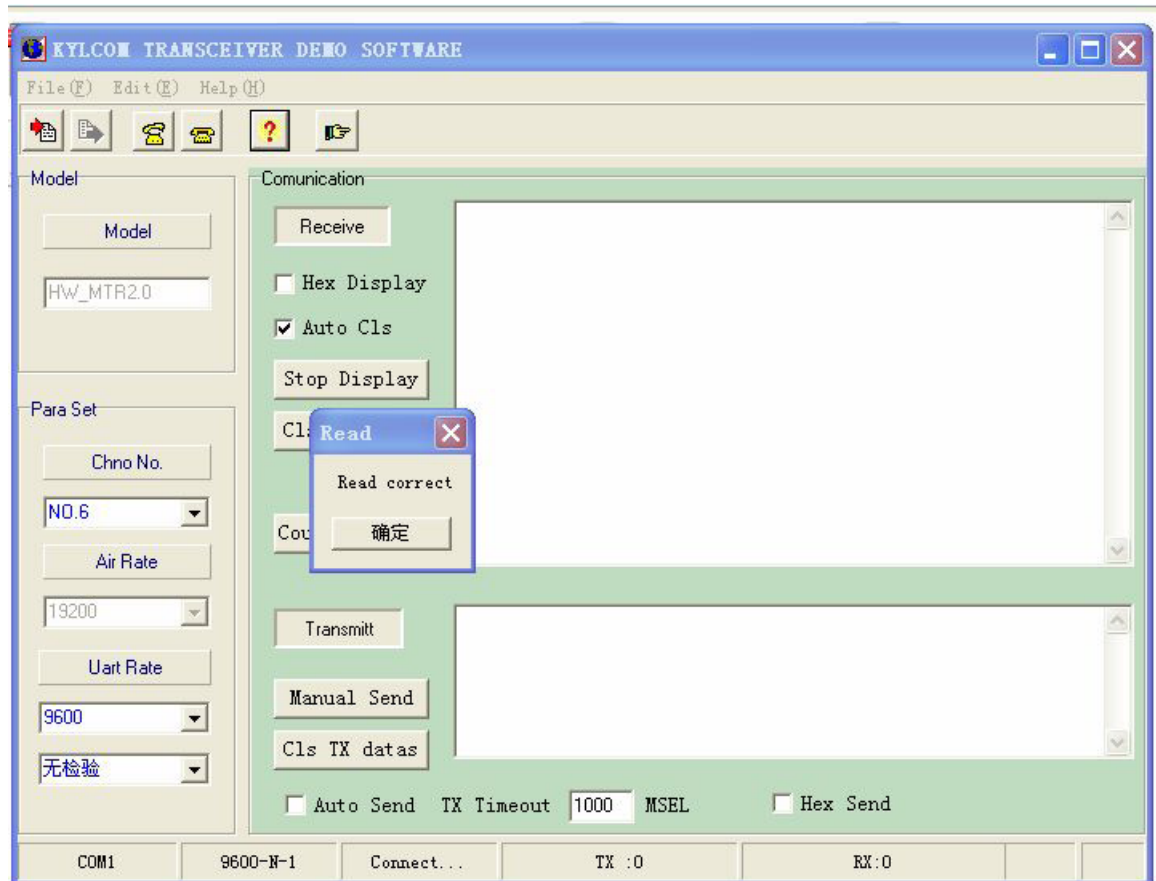

If you want to change some technical parameter, you need do as follows.

- e. User can change the parameter such as channel and interface rate and Parity mode according to actual demand through the button of the left window. After writing the parameters in the left catalogue, click the “write para”, then will show “write correct”. So you have finished the process for changing technical parameter.



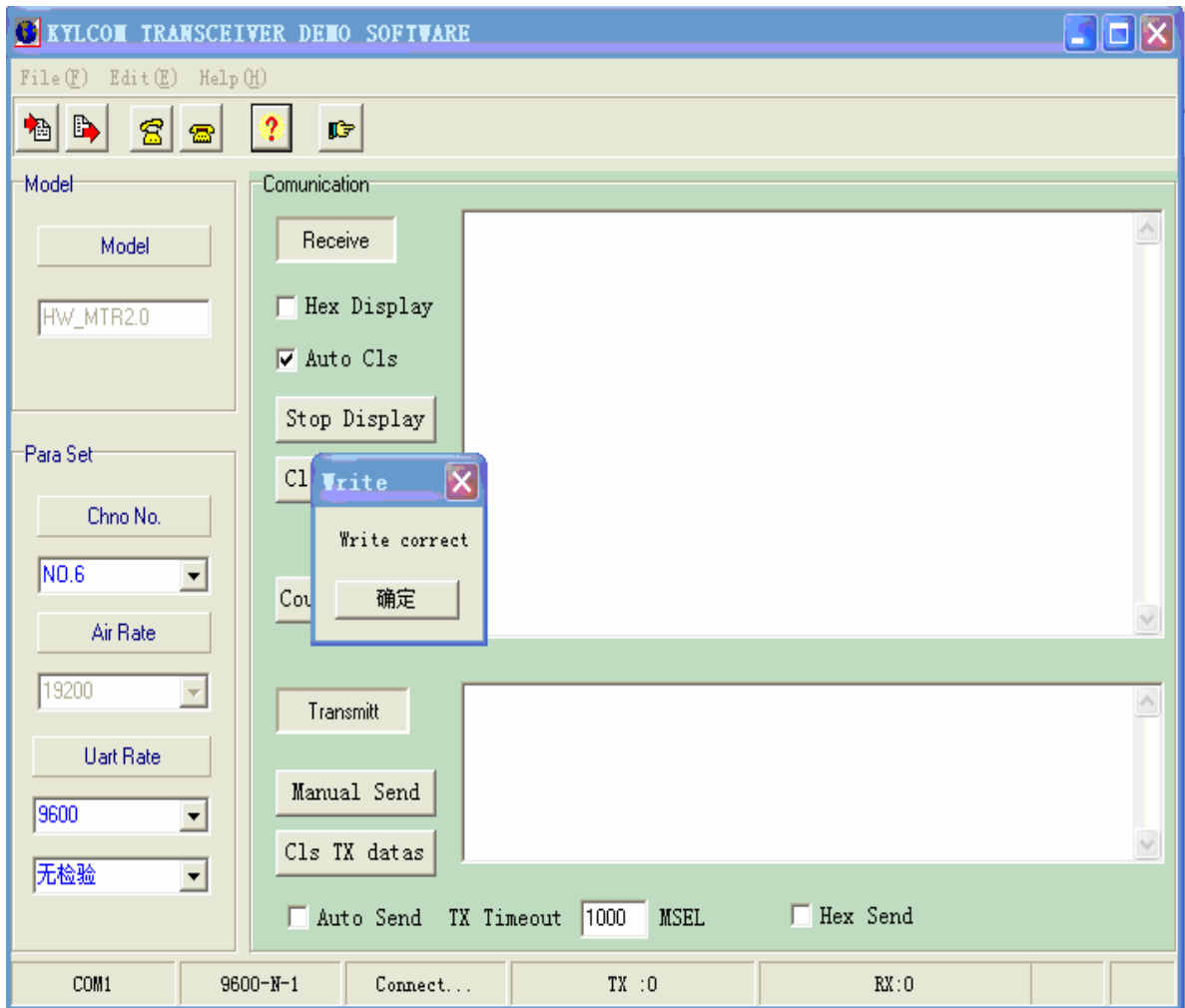

**Note: The RF data rate(Air Rate) can not be set by user, it is confirmed when placing orders and set before delivery. So please confirm the RF data rate when placing the order.**

**5. Installation dimension:**

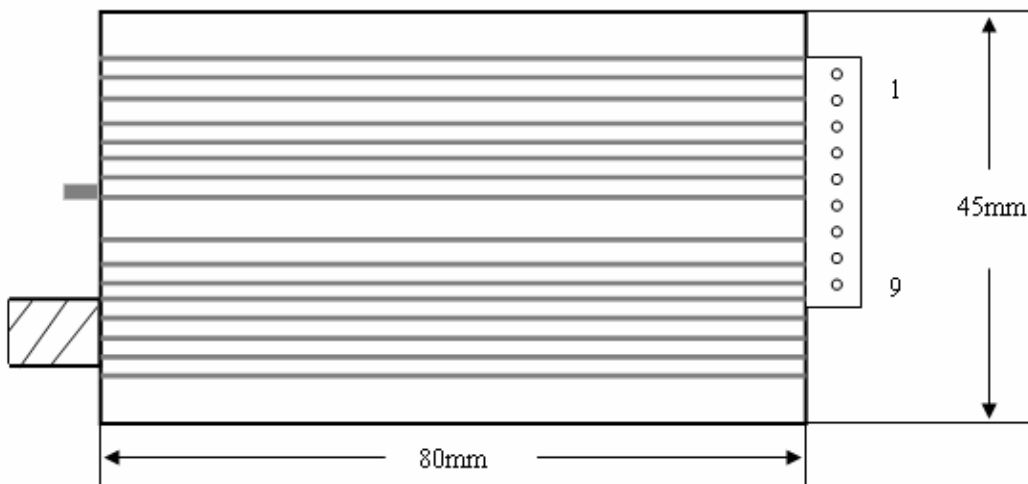

## **6. The Function-indicator light**

- a. The LED indicator light will glitter red for 0.5S once after switched on.
- b. The LED indicator light will glitter green continually while receiving data from air.
- c. The LED indicator light will glitter red continuously when transmitting data into air after receiving from COM.
- d. If the module enables the sleep function, LED indicator light is always dark.

## **7. Supported protocol and Transmit capability**

KYL-300M standard transceivers offer transparent protocol to support various applications and protocols of users. If the user needs to decrease his cost or ease the workload of terminal CPU, we can add other specific functions based on the transparent protocol, such as addressing, data acquisition, command interpretation, etc.

## **8. Sleep function instruction:**

Due to reducing more consumption, KYL-300M transceivers support Sleep function. In sleep mode, the current consumption is less than 20uA.

### **a. How to use the Sleep function:**

The Pin8 ‘SLP’ in JP1 is the signal of sleep control. In high power level, transceiver stays in working mode. In low power level (<0.5V), transceiver stays in sleep mode. The SLP signal can convert transceiver from working to sleep mode in 1ms after falling edge. If the Sleep signal arrives when the transceiver is transmitting data, the module will enter sleep mode after finishing transmission. From sleep mode to working, it takes the transceiver 1ms after rising edge. To disable the opened sleep function of KYL-300M, the SLP (SLEEP) pin should be definitely connected with 0 or ground.

### **b. Attentions about use of sleep function:**

When the sleep function enabled, any supply glitches, such as switch dithering, fire striking or quick switching on and off, could cause the transceiver to be switched to the wrong sleep mode.

After switching on, users can avoid this error by making a compulsive restoration once after the CPU delays 100ms.

### **Sleep Timing Diagram:**

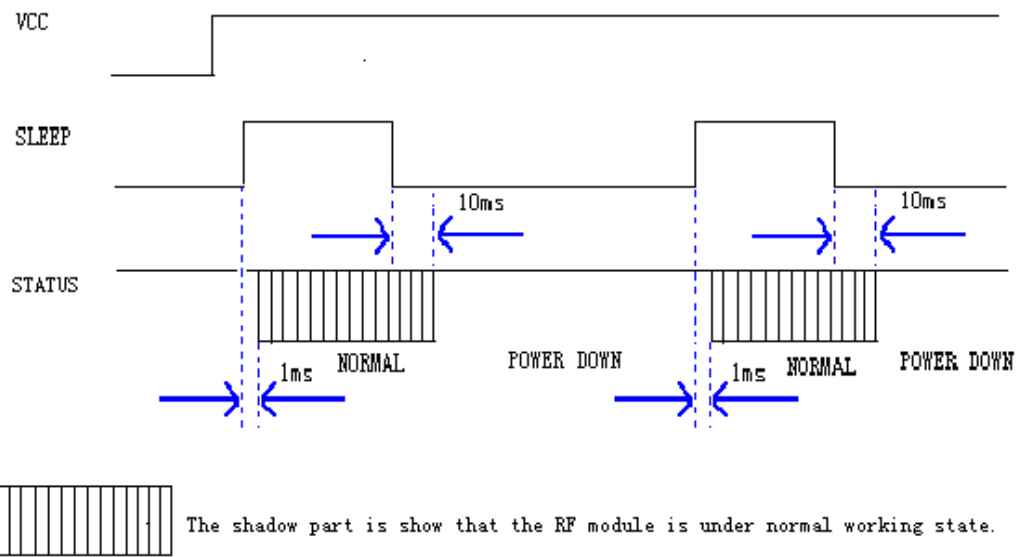

**8. The attentions of data transmission**

a. The delay time ( $t_c$ ) of conversion between transmitting and receiving is less than 1ms.

**Timing diagram:**

KYL SERIES

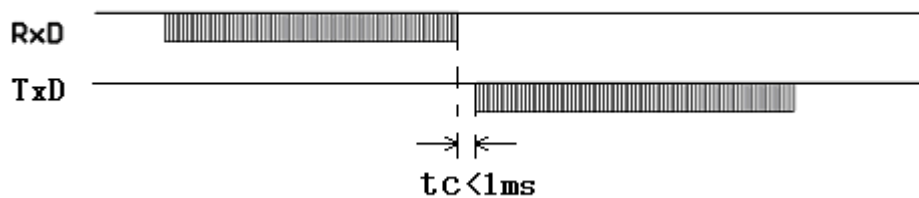

**b. The delay time of transceivers between the first bit sent by TxD to the first bit received by RxD.**

Due to a data processing will be made on user's data by KYL-300M transceiver using FEC (Forward Error Correction) or other correction algorithm, when RxD of a KYL-300M transceiver 'A' receives the data, then transmits it, the other one transceiver 'B' will have a delay ( $t_s$ ) to receive and transmit by TxD. Different RF data rate causes different delay time. Please see the specific delay time below:

RF Date Rate (bps)	Delay Ts(mS)	RF Date Rate (bps)	Delay Ts(mS)
1200	90	9600	16
2400	48	19200	10

4800	30		
------	----	--	--

**Timing diagram:**

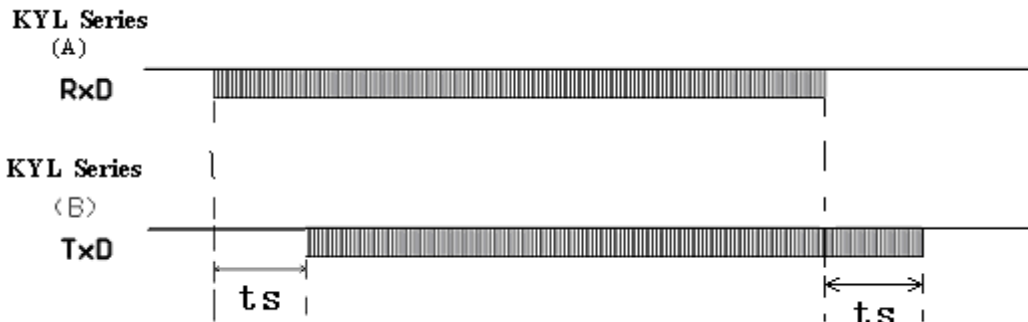

**c. Error dealing procedure:**

To enhance the reliability and stability of user’s systems, a verify bit or a Cyclic Redundancy Check (CRC) mode is highly recommended to resent the wrong information while using KYL-300M modules.

**d. Large-number data transmission**

In theory, when the interface data rate is faster than the RF data rate, KYL-300M transceivers can sent unlimited-long data package, but any long packages more than 120B are not recommended. The length of each package should be between 60~100B. We also recommend user to resent the wrong information using Automatic Error Request Equipment (ARQ).

**The analyzing as below:**

What if the actual transmission BER (Bit Error Rate) is  $10^{-4}$ , 1 packet with 1KB data, which is about 10-thousand bits, is sent, theoretically, at least 1 bit will be received wrongly, then the 1KB information will never be received correctly. But if we package the data into 10 packets with 100B for each, when all 10 packets are sent, there will be only 1 packet wrong according to this probability. After that, resend this wrong packet using ARQ mode. So by resending one more packet and the efficiency rate is reduced 10%, all data will be absolutely received correctly.

**10. Antenna configuration:**

Many appropriate antennas for low power RF modules are selected for meeting different user antenna configurations. Please ask our Sales office for further information about the antenna’s dimension and performance.

a. Helical SMA antennas

KYL-ANT-433-10-SMA: 100mm helical SMA antennas with high gain and low cost, reach a long distance.



KYL-ANT-433-3-SMA: 28mm SMA helical antenna with magnetic core, small size, beautiful appearance (like the mobile phone antenna)



KYL-ANT-433-10-ZSMA: 100mm SMA helical antenna with folding joint, easy for adjusting the direction and fixing.



b. Magnetic vehicle antenna

KYL-ANT-O433S-300H1.5-SMA: include magnetic antenna base, suitable for equipment with metal shell, easy for fixing, effective to enhance the transmission distance.



More kinds of antenna, please browse our website:

[http://www.rf-data.com/Products\\_list\\_en.asp?classid=163](http://www.rf-data.com/Products_list_en.asp?classid=163)

If the user has special demands on antennas, we can design and produce for them specially.

## V. Networking Application of KYL-300M

The communication channel of KYL-300M is half duplex, which is most suitable for the communication mode of point to multi-point. Under this mode, one master station must be set, and all of the rest are slave stations. A unique address is given to each station. The coordination of communication is controlled by master station that uses data frames containing address code to transmit data or command. Slave station will receive all of the data and command and compare the received address code with local address code. If they are different, the data

will be deserted without any response. If those address codes are the same, it means the data is sent to the local. Slave station will make different responses according to the transmitted data or command and send back the data of response. All these jobs must be performed by upper protocol, and it is assured that there is only one transmitter-receiver in the state of transmission in the communication network at any instant moment so as to avoid the cross-interference. KYL-300M can also be used for point-to-point communication with easier operation. For the programming of serial port, all you have to do is to remember that its communication mode is semi duplex while always observing the time sequence of come-and-go for receiving and transmitting.

## VI. Technical specification of KYL-300M

- \* Modulation mode: GFSK/FSK
- \* Working frequency: 400MHz~470MHz;
- \* Power supply: DC 5V (7.5V~12V will inform when placing the order);
- \* RF power:  $\leq 2$ W;
- \* RF data rate: 1200/2400/4800/9600/19200bps (Set before delivery);
- \* Receive current:  $< 30$ mA (TTL connect);
- \* Receive sensitivity: -123dBm (1200bps); -118dBm (9600bps);
- \* Transmitting current:  $< 1.5$ A;
- \* Sleep current:  $< 20$ uA;
- \* Interface data format: 8E1/8N1/8O1;
- \* Working humidity: 10%~90% relative humidity without condensation;
- \* Working temperature:  $-35^{\circ}\text{C} \sim +75^{\circ}\text{C}$  ( industrial)
- \* RF Line-of-sight Range: 5000m(BER=10-5@9600bps);  
7000m(BER=10-5@1200bps);
- \* Size: 80mm\*45mm\*20mm (without antenna port).

## VII. Description of type

