

CJMNT32 PNP Power Transistor with N-MOSFET

$V_{(BR)DSS}/V_R$	$R_{DS(on)MAX}$	I_D/I_C
20V	600mΩ@4.5V	0.8A
	650mΩ@2.5V	
	700mΩ@1.8V	
-32V	/	-1.5A

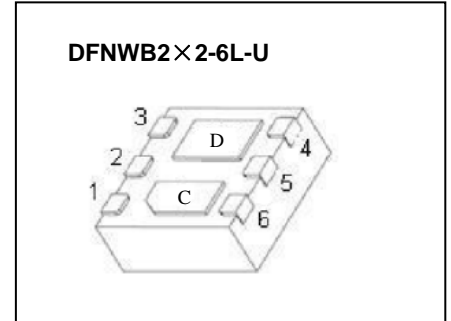

FEATURE

- Ultra low collector-to-emitter saturation voltage
- High DC current gain
- Small package DFNWB2×2-6L-U

APPLICATION

- Charging circuit
- Other power management in portable equipment

MARKING

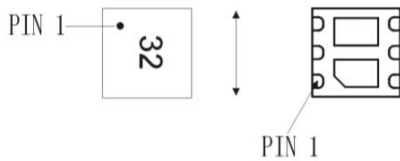

Equivalent circuit

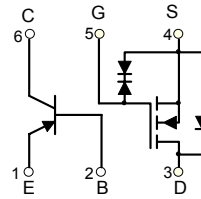

ABSOLUTE MAXIMUM RATINGS (T_a=25°C unless otherwise noted)

Symbol	Parameter	Value	Unit
PNP Transistor			
V _{CBO}	Collector-Base Voltage	-32	V
V _{CEO}	Collector-Emitter Voltage	-32	V
V _{EBO}	Emitter-Base Voltage	-6	V
I _C	Collector Current-Continuous(Note1)	-1.5	A
	Collector Current-Continuous(Note2)	-0.6	A
I _{CM}	Collector Current-Pulse(Note3)	-4	A
N-MOSFET			
V _{DS}	Drain-Source Voltage	20	V
V _{GS}	Gate-Source Voltage	±5	V
I _D	Continuous Drain Current (note 1)	0.8	A
	Collector Current-Continuous(Note2)	0.69	A
I _{DM}	Collector Current-Pulse(Note3)	1.4	A
Power Dissipation, Temperature and Thermal Resistance			
P _D	PowerDissipation	0.7	W
P _C	Power Dissipation (T _c =25°C ,Note1)	2.5	W
R _{θJA}	Thermal Resistance from Junction to Ambient	178.6	°C/W
T _j	Junction Temperature	150	°C
T _{stg}	Storage Te mperature	-55~+150	°C
T _L	Lead Temperature	260	°C

ELECTRICAL CHARACTERISTICS

$T_a=25\text{ }^\circ\text{C}$ unless otherwise specified

Parameter	Symbol	Test Condition	Min	Typ	Max	Unit
PNP Transistor						
Collector-base breakdown voltage	$V_{(BR)CBO}$	$I_C=-1\text{mA}, I_E=0$	-32			V
Collector-emitter breakdown	$V_{(BR)CEO}$	$I_C=-10\text{mA}, I_B=0$	-32			V
Emitter-base breakdown voltage	$V_{(BR)EBO}$	$I_E=-100\text{uA}, I_C=0$	-6			V
Collector cut-off current	I_{CBO}	$V_{CB}=-30\text{V}, I_E=0$			-0.1	μA
Emitter cut-off current	I_{EBO}	$V_{EB}=-5\text{V}, I_C=0$			-0.1	μA
DC current gain	h_{FE}	$V_{CE}=-2\text{V}, I_C=-0.5\text{A}$	100		300	
Collector-emitter saturation voltage	$V_{CE(sat)}$	$I_C=-0.5\text{A}, I_B=-50\text{mA}$			-0.35	V
Base-emitter saturation voltage	$V_{BE(sat)}$	$I_C=-0.5\text{A}, I_B=-50\text{mA}$			-1.5	V
Base-emitter voltage	$V_{BE(on)}$	$V_{CE}=-2\text{V}, I_C=-500\text{mA}$			-1.1	V
N-MOSFET						
STATIC PARAMETERS						
Drain-source breakdown voltage	$V_{(BR)DSS}$	$V_{GS} = 0\text{V}, I_D = 250\mu\text{A}$	20			V
Zero gate voltage drain current	I_{DSS}	$V_{DS} = 16\text{V}, V_{GS} = 0\text{V}$			100	nA
Gate-body leakage current	I_{GSS}	$V_{GS} = \pm 5\text{V}, V_{DS} = 0\text{V}$			± 1	μA
Gate threshold voltage (note 3)	$V_{GS(th)}$	$V_{DS} = V_{GS}, I_D = 250\mu\text{A}$	0.44		1.1	V
Drain-source on-resistance(note 3)	$R_{DS(on)}$	$V_{GS} = 4.5\text{V}, I_D = 0.55\text{A}$			600	$\text{m}\Omega$
		$V_{GS} = 2.5\text{V}, I_D = 0.5\text{A}$			650	$\text{m}\Omega$
		$V_{GS} = 1.8\text{V}, I_D = 0.35\text{A}$			700	$\text{m}\Omega$
Diode forward voltage (note 3)	V_{SD}	$I_S = 0.35\text{A}, V_{GS} = 0\text{V}$	0.5		1.1	V
DYNAMIC PARAMETERS (note 4)						
Input Capacitance	C_{iss}	$V_{DS} = 10\text{V}, V_{GS} = 0\text{V}, f = 100\text{KHz}$		61		pF
Output Capacitance	C_{oss}			17		pF
Reverse Transfer Capacitance	C_{rss}			10		pF
SWITCHING PARAMETERS (note 4)						
Turn-on delay time	$t_{d(on)}$	$V_{GEN}=4.5\text{V}, V_{DD}=10\text{V},$ $I_D=500\text{mA}, R_{GEN}=6\Omega$ $R_L=10\Omega$		33		ns
Turn-on rise time	t_r			102		ns
Turn-off delay time	$t_{d(off)}$			790		ns
Turn-off fall time	t_f			439		ns
Total Gate Charge	Q_g	$V_{DS}=10\text{V}, V_{GS}=4.5\text{V}$ $I_D=0.6\text{A}$		1.15		nC
Gate-Source Charge	Q_{gs}			0.15		nC
Gate-Drain Charge	Q_{gd}			0.23		nC

Notes :

- 1.Surface mounted on FR4 board using 1 square inch pad size,1oz copper.
- 2.Surface mounted on FR4 board using the minimum pad size,1oz copper.
3. Pulse test : Pulse width=300 μs , duty cycle $\leq 2\%$.
4. These parameters have no way to verify.

Typical Characteristics

PNP Transistor

Static Characteristic

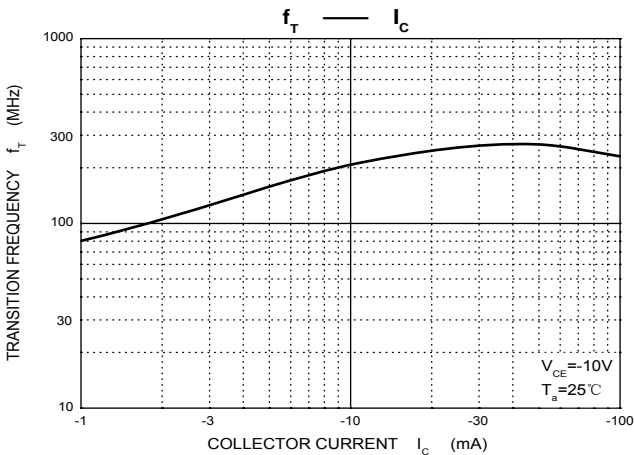
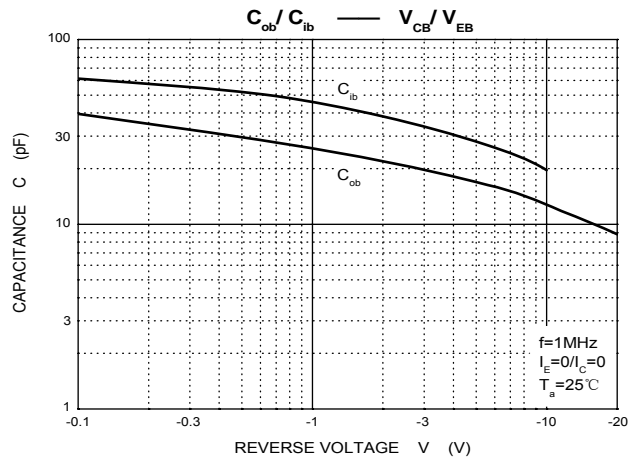
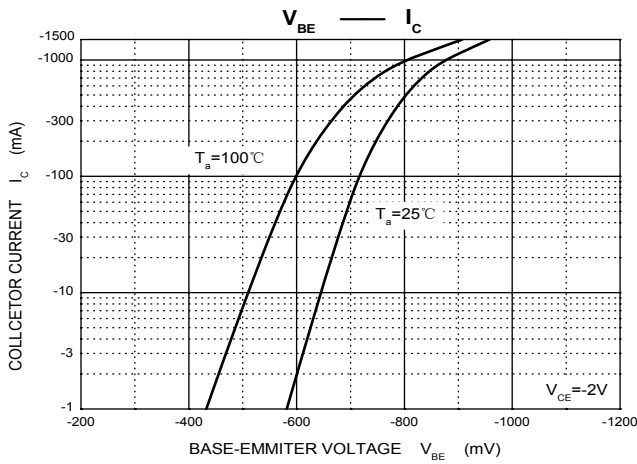
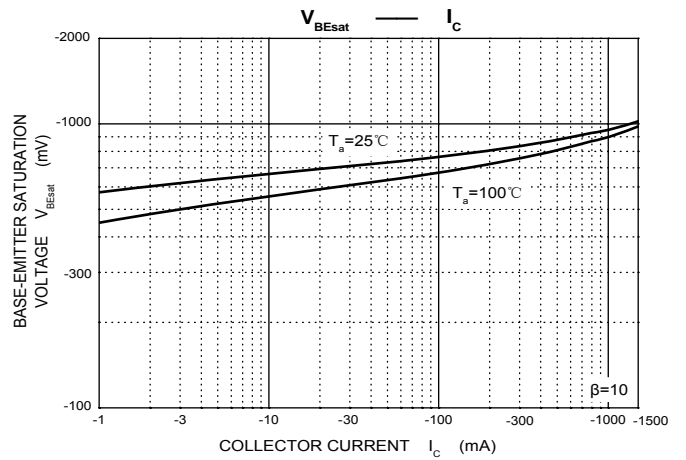
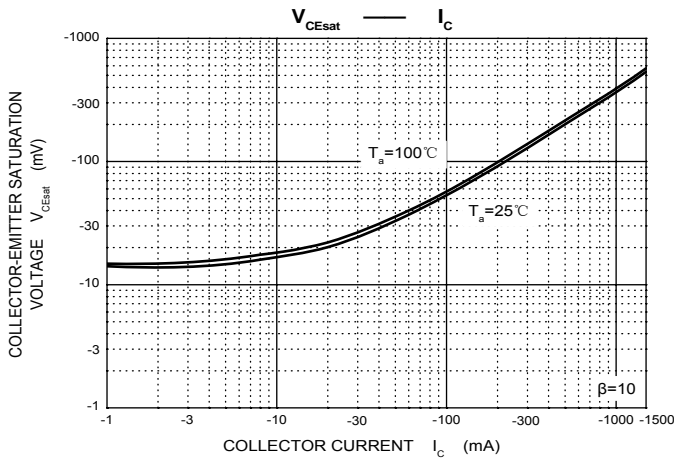
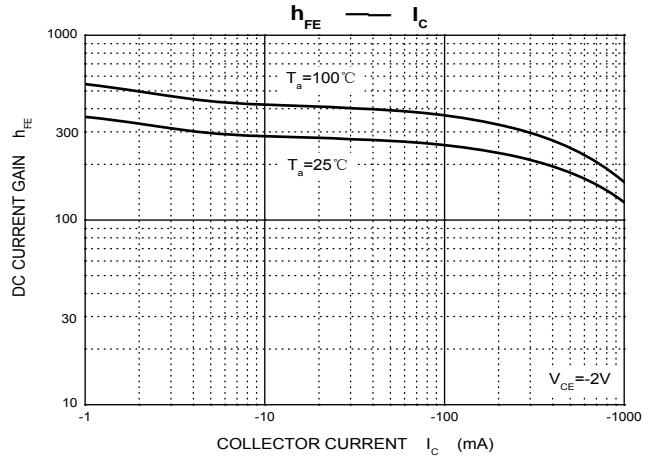
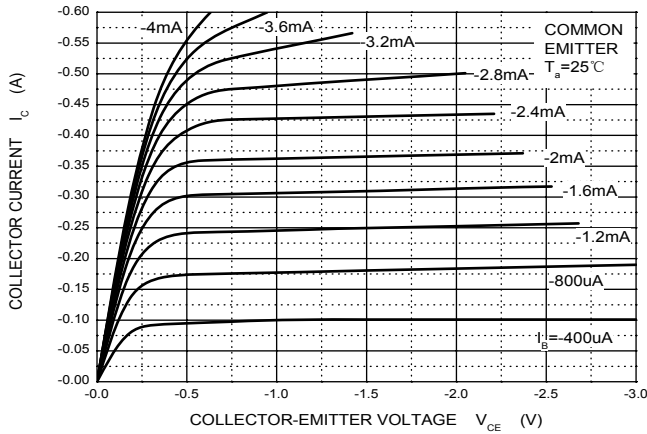

Typical Characteristics

N-channel Characteristics

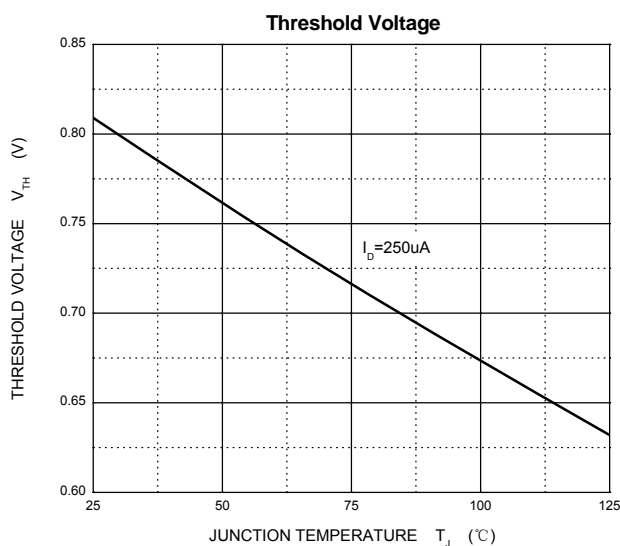
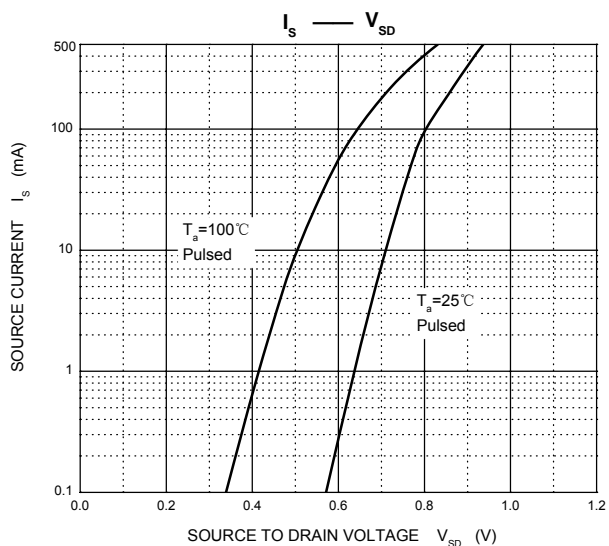
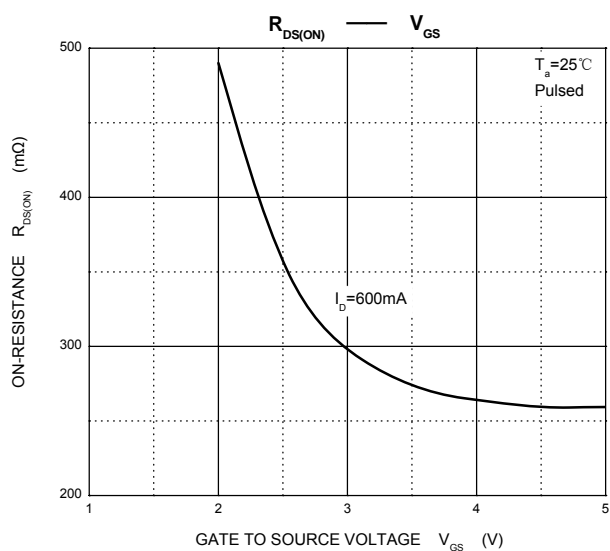
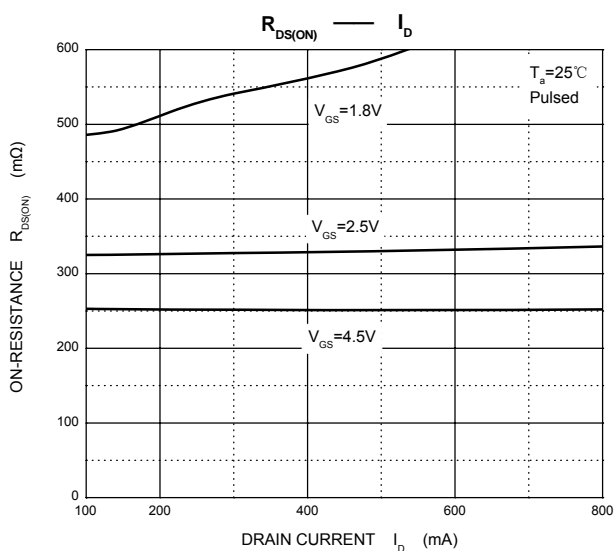
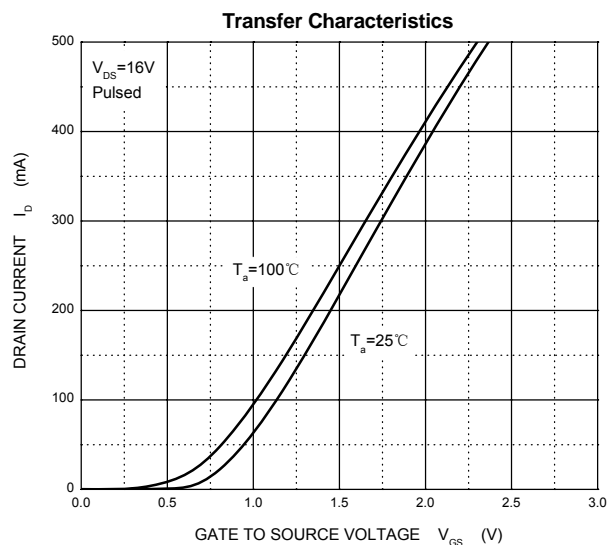
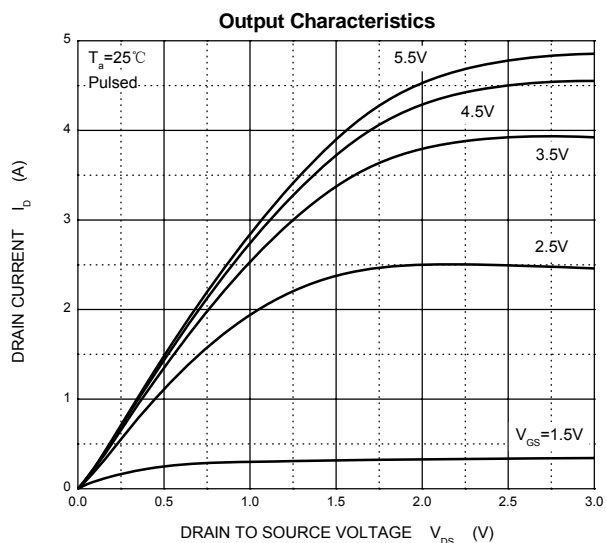

DFNWB2×2-6L-U Package Outline Dimensions

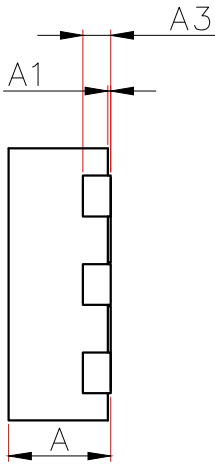
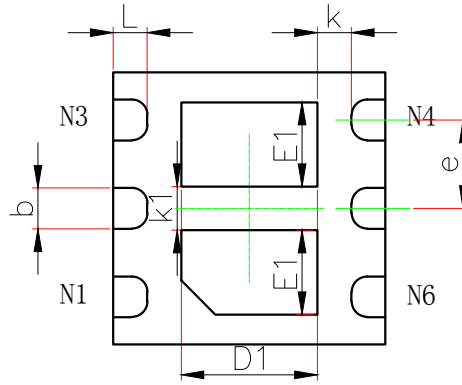
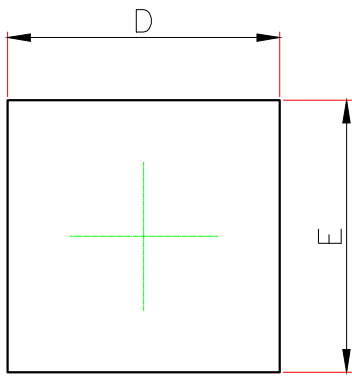

Symbol	Dimensions In Millimeters		Dimensions In Inches	
	MIN.	MAX.	MIN.	MAX.
A	0.700	0.800	0.028	0.031
A1	0.000	0.050	0.000	0.002
A3	0.203REF.		0.008REF.	
D	1.900	2.100	0.075	0.083
E	1.900	2.100	0.075	0.083
D1	0.900	1.100	0.035	0.043
E1	0.520	0.720	0.020	0.028
b	0.250	0.350	0.010	0.014
e	0.650TYP.		0.026TYP.	
k	0.200MIN.		0.008MIN.	
k1	0.320REF.		0.013REF.	
L	0.200	0.300	0.008	0.012

DFNWB2×2-6L-U Suggested Pad Layout

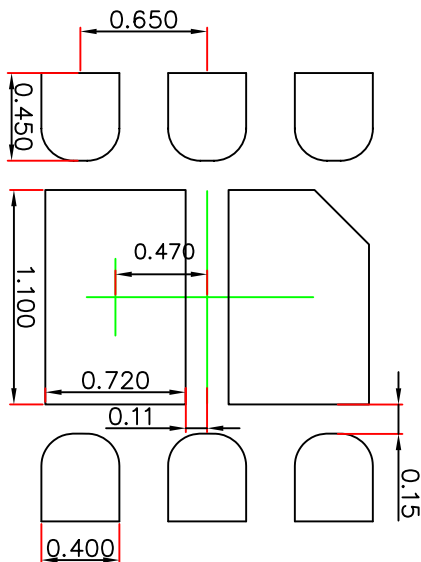

Note:

1. Controlling dimension: in millimeters.
2. General tolerance: ± 0.050 mm.
3. The pad layout is for reference purposes only.

NOTICE

JCET reserve the right to make modifications, enhancements, improvements, corrections or other changes without further notice to any product herein. JCET does not assume any liability arising out of the application or use of any product described herein.

DFNWB2X2-6L Tape and Reel

DFNWB2×2-6L Embossed Carrier Tape

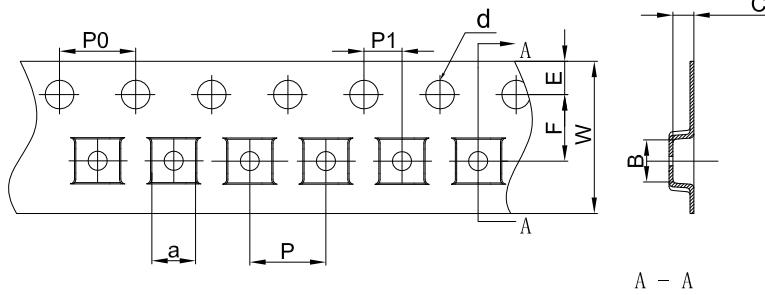

Packaging Description:

DFNWB2×2-6L parts are shipped in tape. The carrier tape is made from a dissipative (carbon filled) polycarbonate resin. The cover tape is a multilayer film (Heat Activated Adhesive in nature) primarily composed of polyester film, adhesive layer, sealant, and anti-static sprayed agent. These reeled parts in standard option are shipped with 3,000 units per 7" or 18.0cm diameter reel. The reels are clear in color and is made of polystyrene plastic (anti-static coated).

Dimensions are in millimeter

Pkg type	a	B	C	d	E	F	P0	P	P1	W
DFNWB2×2-6L	2.30	2.30	1.10	Ø1.50	1.75	3.50	4.00	4.00	2.00	8.00

DFNWB2×2-6L Tape Leader and Trailer

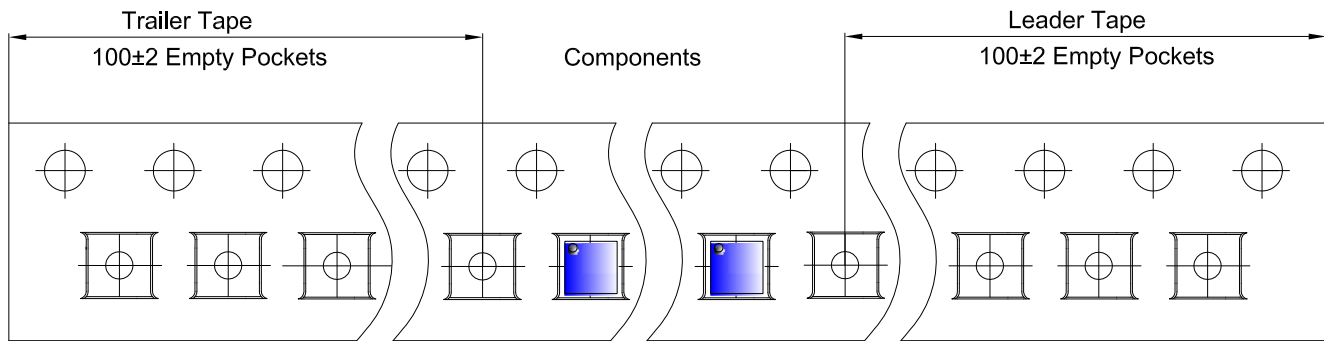

DFNWB2×2-6L Reel

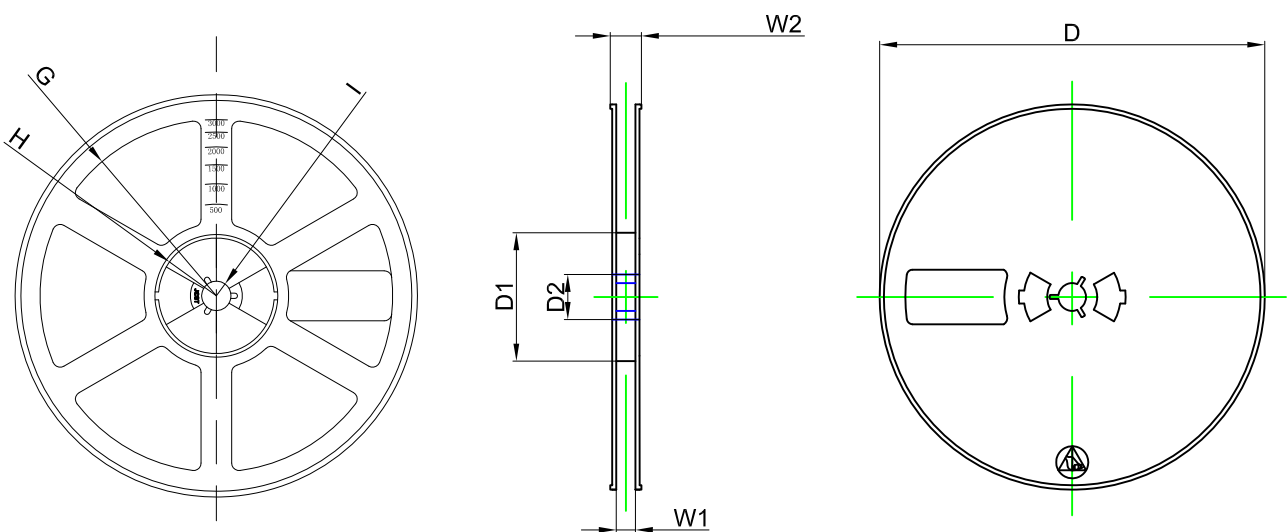

Dimensions are in millimeter

Reel Option	D	D1	D2	G	H	I	W1	W2
7"Dia	Ø180.00	60.00	13.00	R78.00	R25.60	R6.50	9.50	13.10

REEL	Reel Size	Box	Box Size(mm)	Carton	Carton Size(mm)	G.W.(kg)
3000 pcs	7 inch	30,000 pcs	203×203×195	120,000 pcs	438×438×220	