



# 4 and 8-Channel EMI Filter Arrays with ESD Protection

## CM1407

### Features

- Four and eight channels of EMI filtering with ESD protection
- Greater than 25dB of attenuation from 800MHz to 3GHz
- 15kV ESD protection (IEC 61000-4-2, contact discharge)
- 30kV ESD protection (MIL-STD-883, Method 3015, HBM)
- Fabricated with *Centurion*™ advanced low capacitance zener process technology
- Space saving, low profile 8 and 16-lead 0.5mm pitch TDFN packages
- Lead-free version available

### Applications

- I/O port protection for mobile handsets, notebook computers, PDAs etc.
- EMI filtering for data ports in cell phones, PDAs or notebook computers.
- EMI filtering for LCD, camera and chip-to-chip data lines

### Product Description

California Micro Devices CM1407 is an EMI filter array with ESD protection, which integrates either four or eight pi filters (C-R-C). The CM1407 has component values of 7.5pF-200W-7.5pF ( $f_c = 210\text{MHz}$ ). The parts include ESD protection diodes on every pin, providing a very high level of protection for sensitive electronic components that may be subjected to electrostatic discharge (ESD). The ESD diodes connected to the filter ports safely dissipate ESD strikes of •15kV contact discharge, twice the specification requirement of the IEC 61000-4-2, Level 4 international standard. Using the MIL-STD-883 (Method 3015) specification for Human Body Model (HBM) ESD, the pins are protected for contact discharges at greater than •30kV.

This device is particularly well-suited for portable electronics (e.g. mobile handsets, PDAs, notebook computers) because of its small package and easy-to-use pin assignments. In particular, the CM1407 is ideal for EMI filtering and protecting data lines from ESD in wireless handsets.

The CM1407 is available in space-saving, low-profile, 8 and 16-lead TDFN packages. It is fabricated with California Micro Devices' *Centurion*™ process and available with optional lead-free finishing.

### Block Diagram

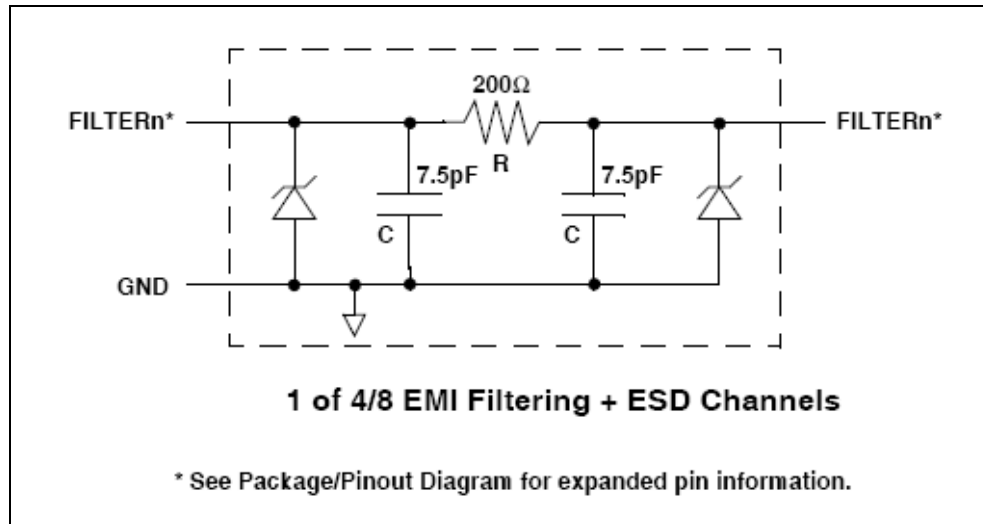

### PACKAGE / PINOUT DIAGRAMS

CM1407-04DE/DF  
8-Lead TDFN Package

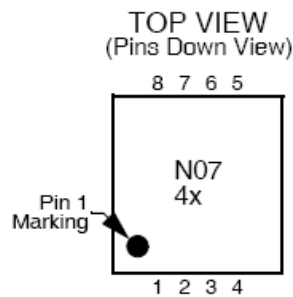

BOTTOM VIEW  
(Pins Up View)

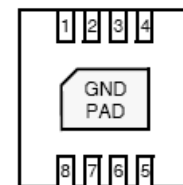

CM1407-08DE/DF  
16-Lead TDFN Package  
with Exposed End Pads

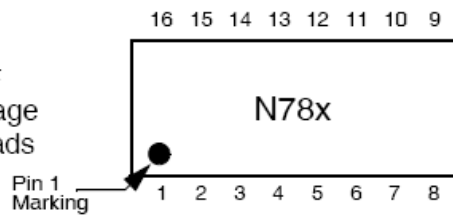

**Notes:**

- 1) This drawing is not to scale.
- 2) See Ordering Information section below for device specific marking.

# CM1407

## PIN DESCRIPTIONS

Pins		NAME	DESCRIPTION	Pins		NAME	DESCRIPTION
CM1407 -04Dx	CM1407 -08Dx			CM1407 -04Dx	CM1407 -08Dx		
1	1	FILTER1	Filter Channel 1	8	16	FILTER1	Filter Channel 1
2	2	FILTER2	Filter Channel 2	7	15	FILTER2	Filter Channel 2
3	3	FILTER3	Filter Channel 3	6	14	FILTER3	Filter Channel 3
4	4	FILTER4	Filter Channel 4	5	13	FILTER4	Filter Channel 4
	5	FILTER5	Filter Channel 5		12	FILTER5	Filter Channel 5
	6	FILTER6	Filter Channel 6		11	FILTER6	Filter Channel 6
	7	FILTER7	Filter Channel 7		10	FILTER7	Filter Channel 7
	8	FILTER8	Filter Channel 8		9	FILTER8	Filter Channel 8
GND Pad		GND	Device Ground				

## Ordering Information

### PART NUMBERING INFORMATION

Leads/Pins	Package	Standard Finish		Lead-free Finish	
		Ordering Part Number <sup>1</sup>	Part Marking	Ordering Part Number <sup>1</sup>	Part Marking
8	TDFN-08	CM1407-04DF	N07 4F	CM1407-04DE	N07 4E
16	TDFN-16EEP	CM1407-08DF	N78F	CM1407-08DE	N78E

Note 1: Parts are shipped in Tape & Reel form unless otherwise specified.

## Specifications

### ABSOLUTE MAXIMUM RATINGS

PARAMETER	RATING	UNITS
Storage Temperature Range	-65 to +150	°C
DC Power Rating per Resistor	100	mW
Package DC Power Rating	300	mW

### STANDARD OPERATING CONDITIONS

PARAMETER	RATING	UNITS
Operating Temperature Range	-40 to +85	°C

### ELECTRICAL OPERATING CHARACTERISTICS (SEE NOTE 1)

SYMBOL	PARAMETER	CONDITIONS	MIN	TYP	MAX	UNITS
R	Resistance		160	200	240	$\Omega$
C	Capacitance	At 2.5V DC, 1MHz, 30mV AC	6	7.5	9	pF
$V_{DIODE}$	Diode Standoff Voltage	$I_{DIODE} = 10\mu A$		6.0		V
$I_{LEAK}$	Diode Leakage Current (reverse bias)	$V_{DIODE} = 3.3V$		0.1	1	$\mu A$
$V_{SIG}$	Signal Voltage Positive Clamp Negative Clamp	$I_{LOAD} = 10mA$ $I_{LOAD} = -10mA$	5.6 -1.5	6.8 -0.8	9.0 -0.4	V V
$V_{ESD}$	In-system ESD Withstand Voltage a) Human Body Model, MIL-STD-883, Method 3015 b) Contact Discharge per IEC 61000-4-2 Level 4	Note 2	30 15			kV kV

Note 1:  $T_A = 25^\circ C$  unless otherwise specified.

Note 2: ESD applied to input and output pins with respect to GND, one at a time.

## Performance Information

**Typical Filter Performance** (nominal conditions unless specified otherwise, 0V DC Bias, 50 Ohm Environment)

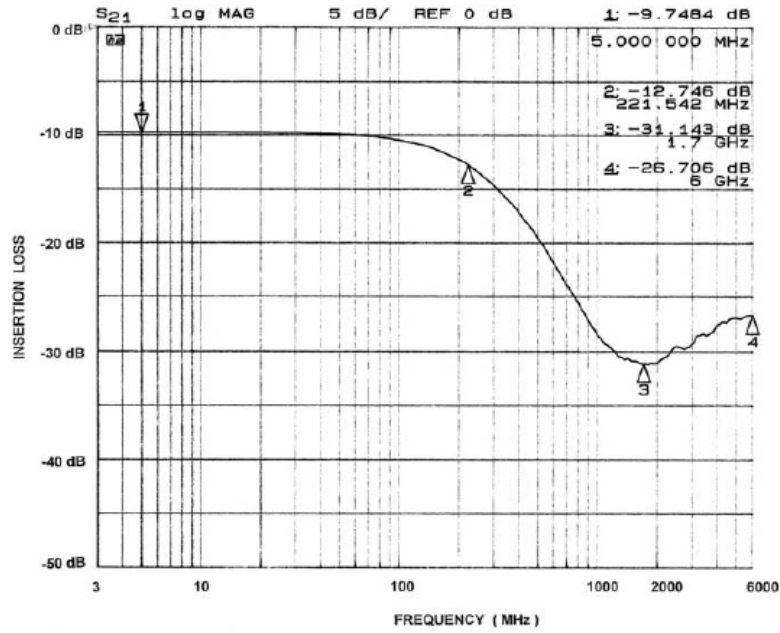

Figure 1. Channel 1 EMI Filter Performance (CM1407-04)

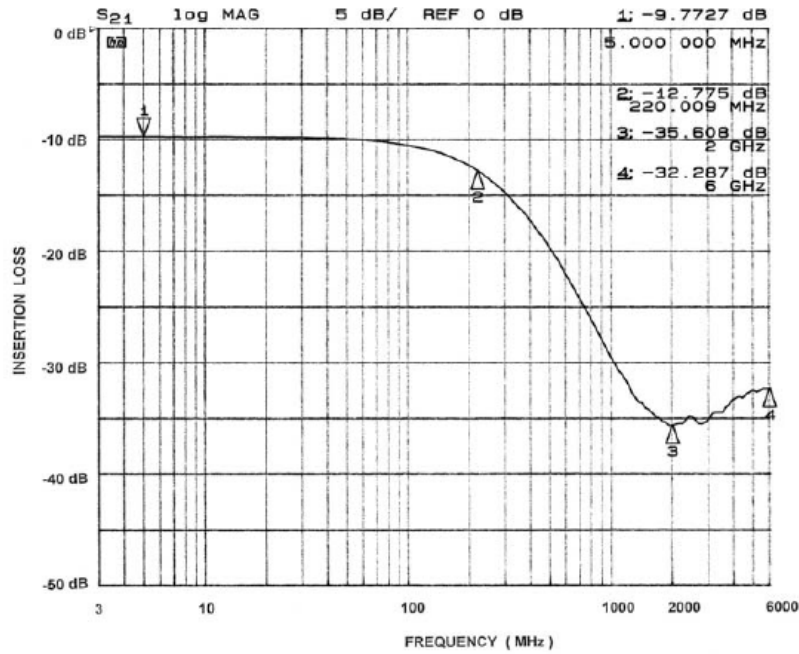
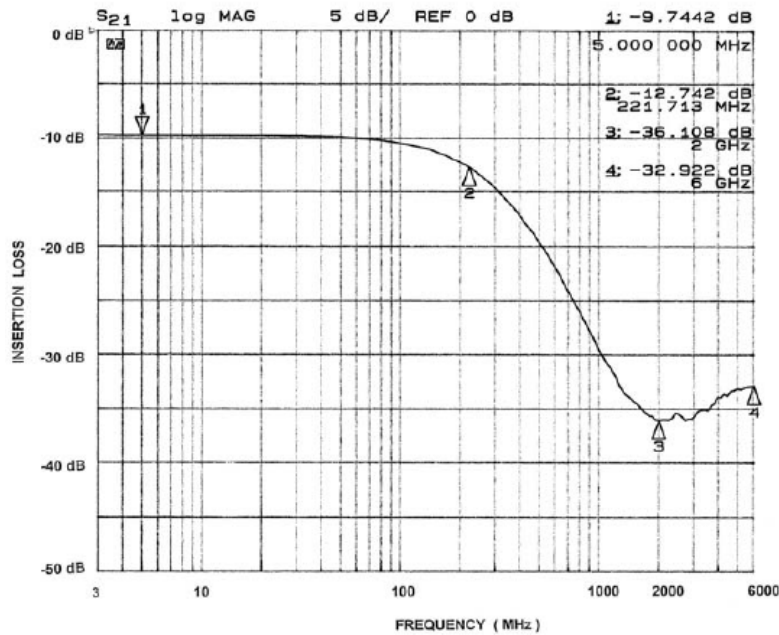

Figure 2. Channel 2 EMI Filter Performance (CM1407-04)

## Performance Information (cont'd)

**Typical Filter Performance** (nominal conditions unless specified otherwise, 0V DC Bias, 50 Ohm Environment)



**Figure 3. Channel 3 EMI Filter Performance (CM1407-04)**

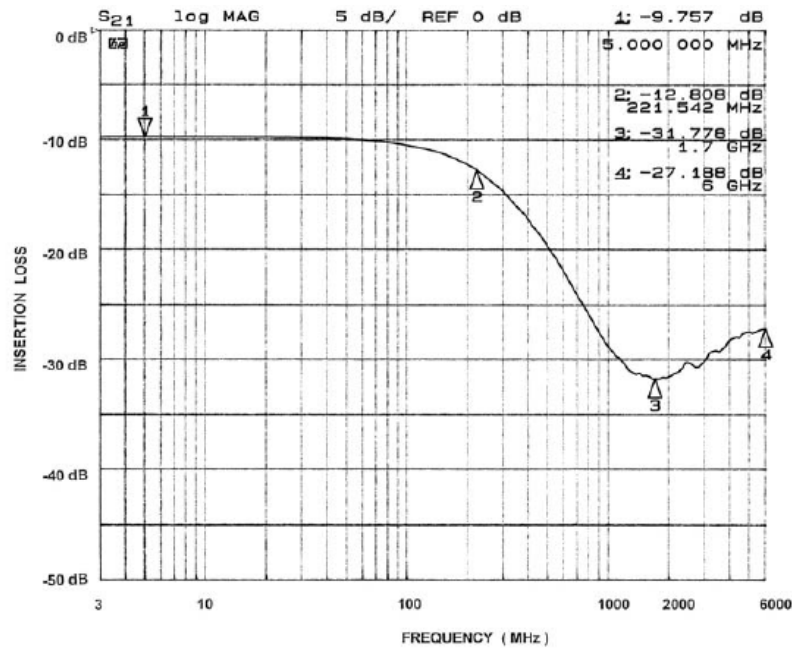

**Figure 4. Channel 4 EMI Filter Performance (CM1407-04)**

## Performance Information (cont'd)

**Typical Filter Performance** (nominal conditions unless specified otherwise, 0V DC Bias, 50 Ohm Environment)

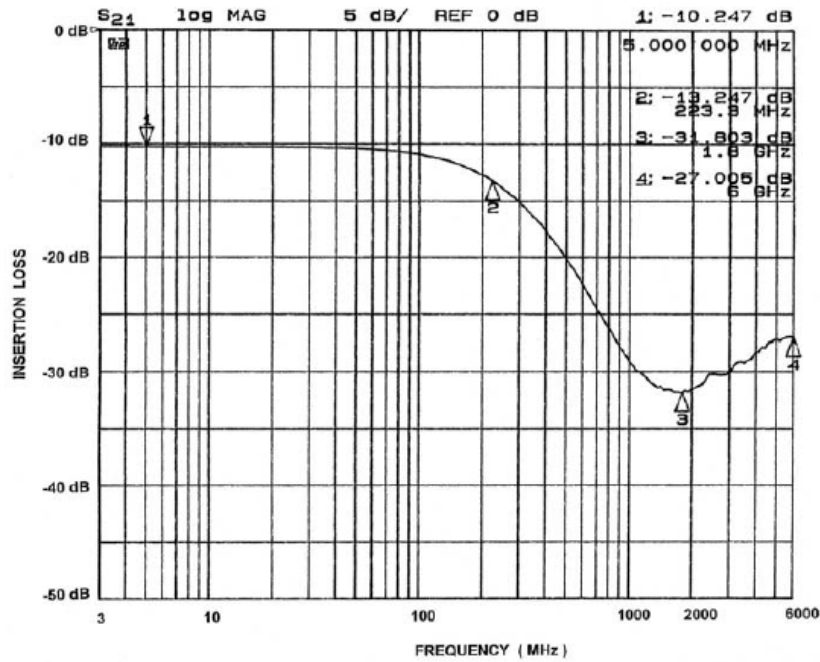

Figure 5. Channel 1 EMI Filter Performance (CM1407-08)

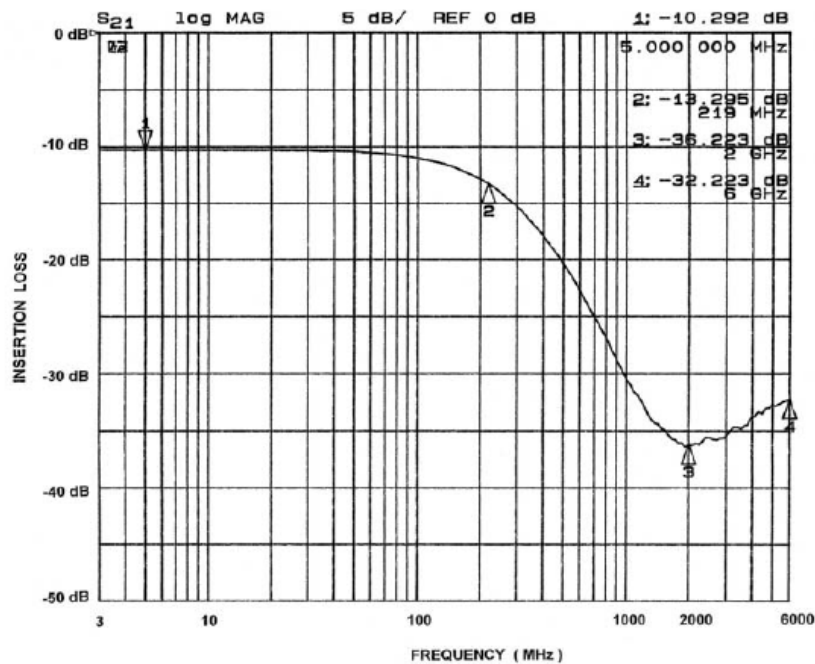

Figure 6. Channel 2 EMI Filter Performance (CM1407-08)

## Performance Information (cont'd)

**Typical Filter Performance** (nominal conditions unless specified otherwise, 0V DC Bias, 50 Ohm Environment)

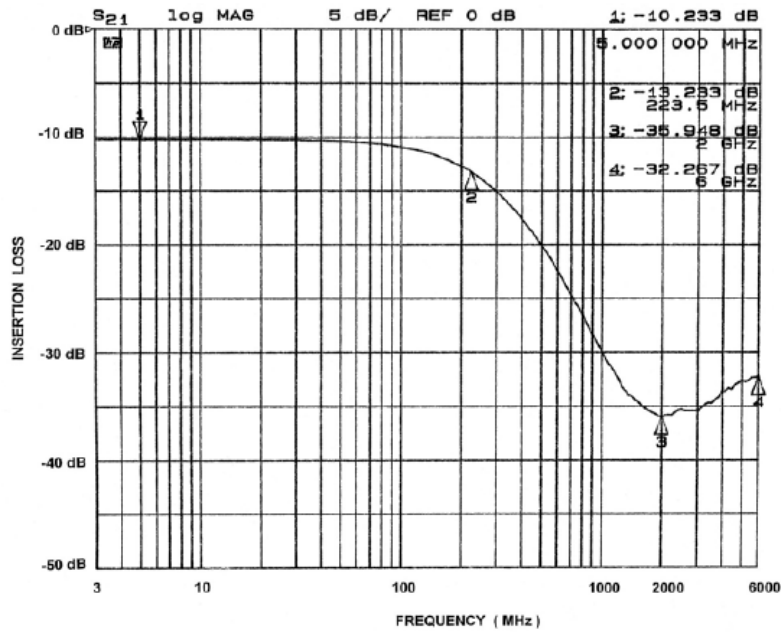

Figure 7. Channel 3 EMI Filter Performance (CM1407-08)

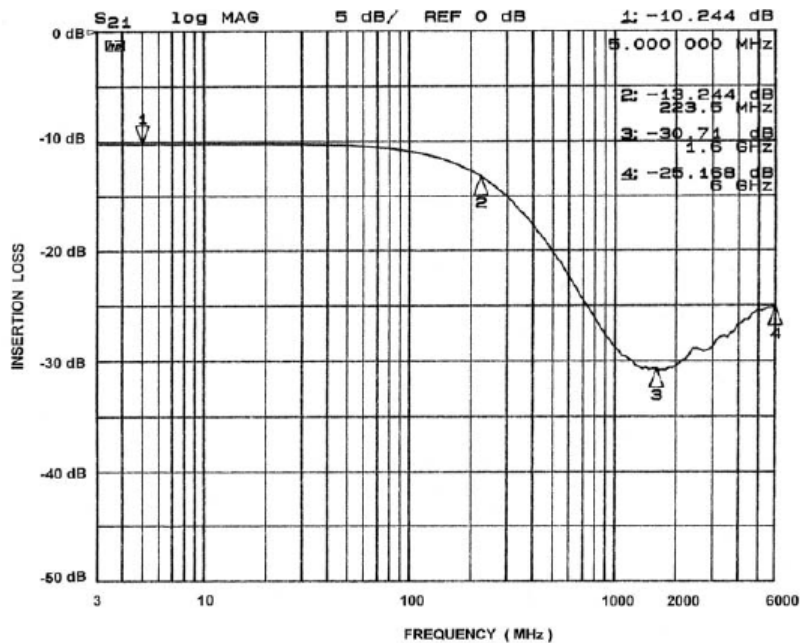

Figure 8. Channel 4 EMI Filter Performance (CM1407-08)



## Performance Information (cont'd)

**Typical Filter Performance** (nominal conditions unless specified otherwise, 0V DC Bias, 50 Ohm Environment)

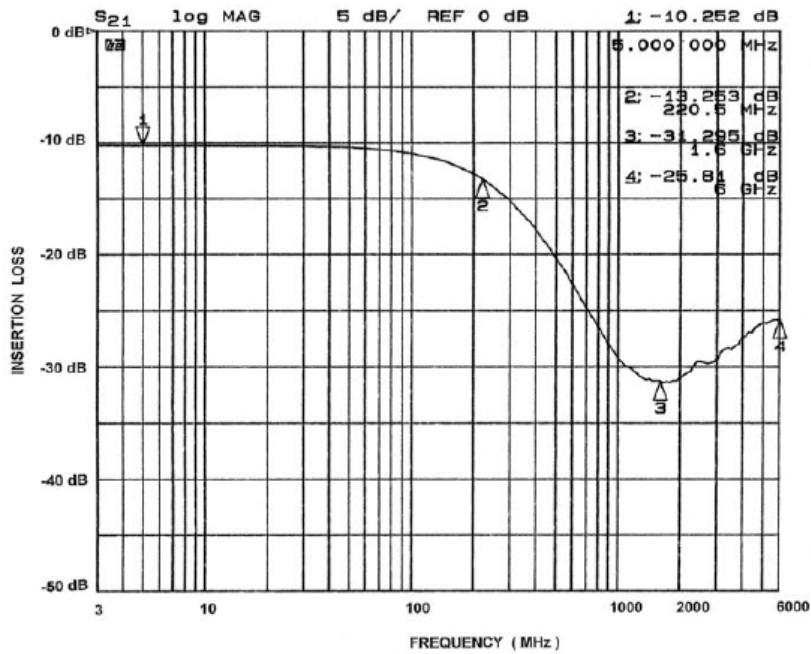

Figure 9. Channel 5 EMI Filter Performance (CM1407-08)

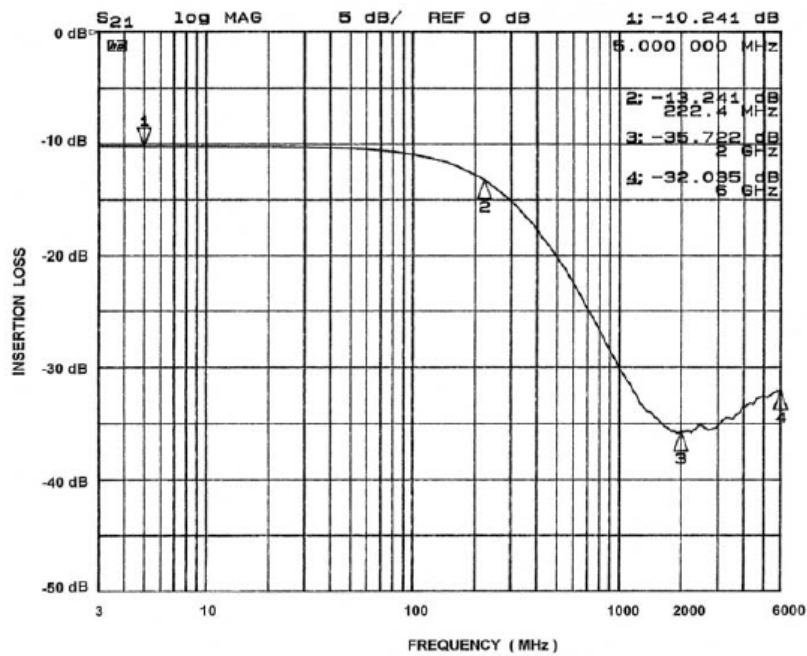

Figure 10. Channel 6 EMI Filter Performance (CM1407-08)

## Performance Information (cont'd)

**Typical Filter Performance** (nominal conditions unless specified otherwise, 0V DC Bias, 50 Ohm Environment)

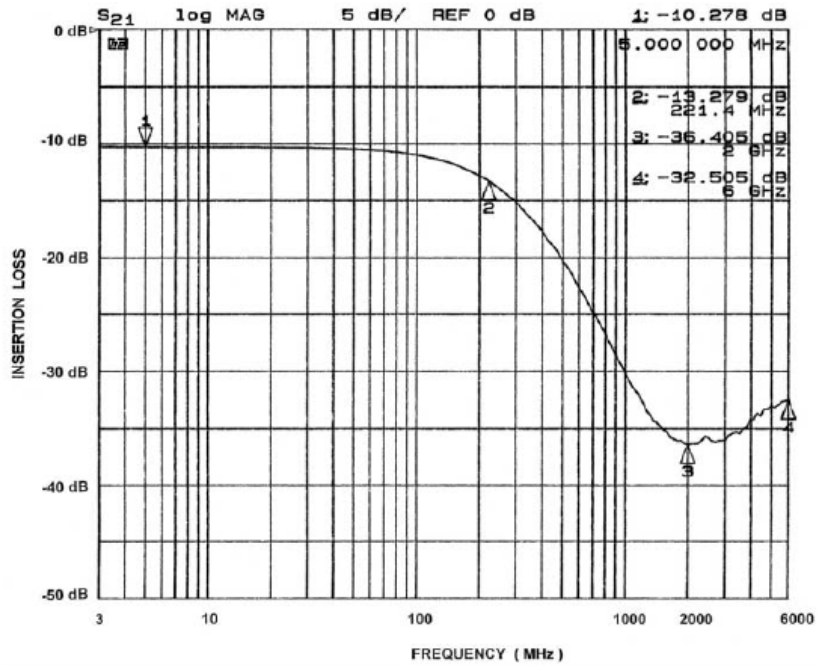

Figure 11. Channel 7 EMI Filter Performance (CM1407-08)

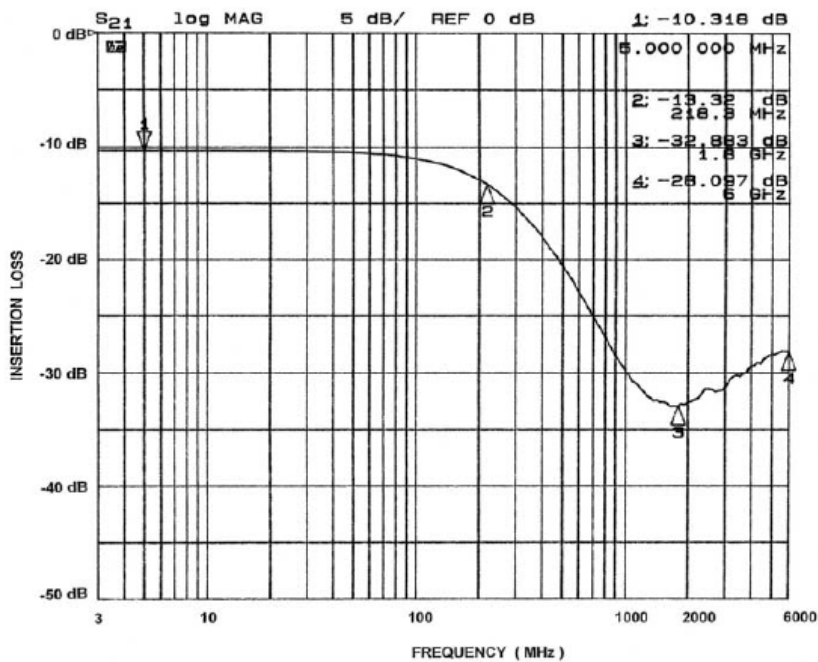

Figure 12. Channel 8 EMI Filter Performance (CM1407-08)

Performance Information (cont'd)

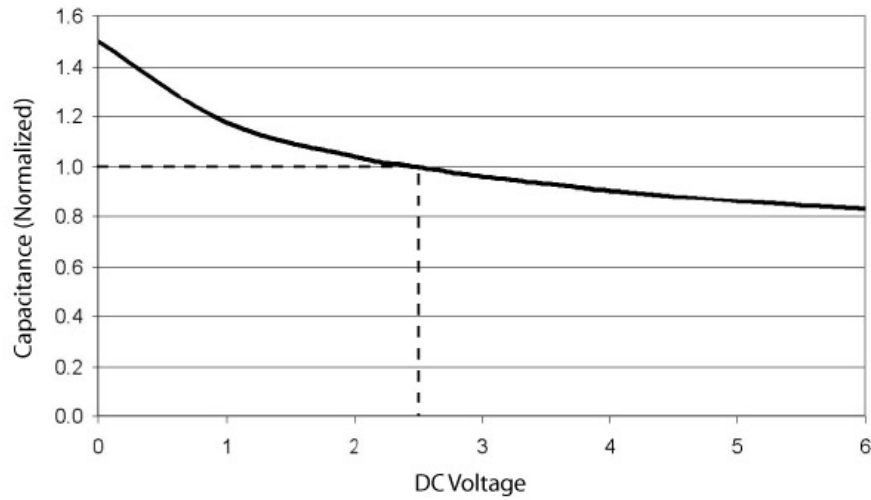

Figure 13. Filter Capacitance vs. Input Voltage over Temperature (normalized to capacitance at 2.5VDC and 25°C)

## Mechanical Details

### TDFN-08 Mechanical Specifications

Dimensions for CM1407-04DE/DF device packaged in an 8-lead TDFN package are presented below.

PACKAGE DIMENSIONS						
Package	TDFN					
JEDEC No.	MO-229 (Var. VCCD-3)					
Leads	8					
Dim.	Millimeters			Inches		
	Min	Nom	Max	Min	Nom	Max
A	0.70	0.75	0.80	0.028	0.030	0.032
A3	0.20 REF			0.008 REF		
b	0.20	0.25	0.30	0.008	0.010	0.012
D	1.95	2.00	2.05	0.077	0.079	0.081
D2	1.55	1.60	1.65	0.061	0.063	0.065
E	1.95	2.00	2.05	0.077	0.079	0.081
E2	0.85	0.90	0.95	0.033	0.035	0.037
e	0.50 BSC			0.020 BSC		
K	0.20			0.008		
L	0.25	0.30	0.35	0.010	0.012	0.014
# per tape and reel	3000 pieces					
Controlling dimension: millimeters						

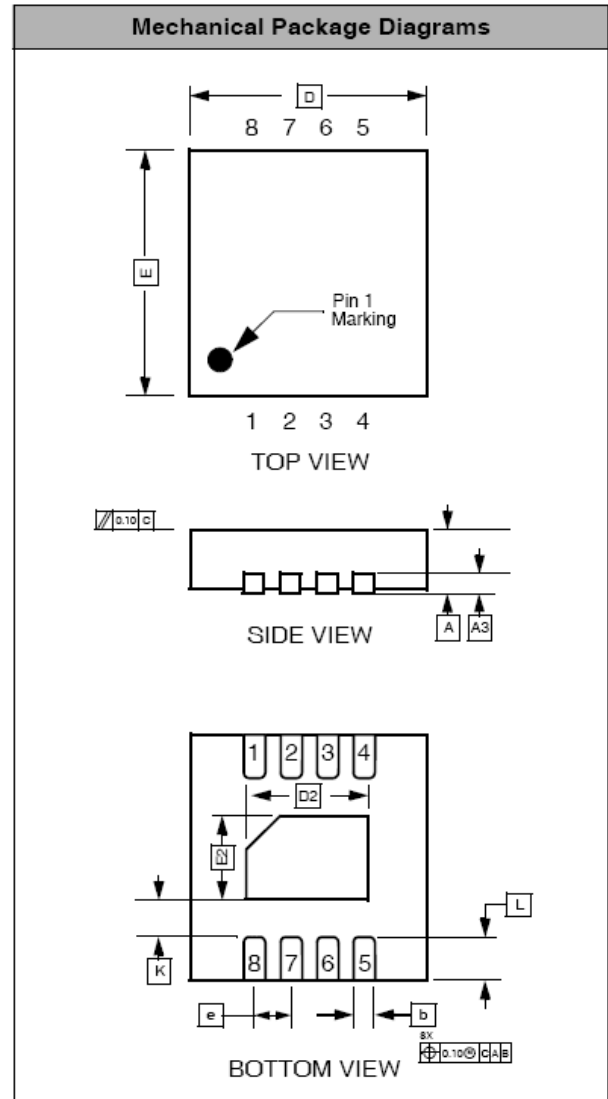

Package Dimensions for 8-Lead TDFN

This package is compliant with JEDEC standard MO-229, variation VCCD-3 with exception of the "D2" and "E2" dimensions as called out in the table above and the "r1" dimension which is not specified in the MO-229 standard.

## Mechanical Details (cont'd)

### TDFN-16 Mechanical Specifications

The CM1407-08DF/DE is supplied in an 16-lead, 0.5mm pitch TDFN package with Exposed End Pads (EEP). Dimensions are presented below.

PACKAGE DIMENSIONS						
Package	TDFN					
JEDEC No.	MO-229C					
Leads	16					
Dim.	Millimeters			Inches		
	Min	Nom	Max	Min	Nom	Max
A	0.70	0.75	0.80	0.028	0.030	0.031
A1	0.00	0.02	0.05	0.000	0.001	0.002
A3	0.20 REF			0.008 REF		
b	0.20	0.25	0.30	0.008	0.010	0.012
D	3.90	4.00	4.10	0.153	0.157	0.161
D2	3.10	3.20	3.30	0.122	0.126	0.130
E	1.50	1.60	1.70	0.059	0.063	0.067
E2	0.30	0.40	0.50	0.012	0.016	0.020
e	0.50 BSC			0.020 BSC		
K	0.20			0.008		
L	0.20	0.30	0.40	0.008	0.010	0.012
M	0.25 REF			0.010 REF		
# per tape and reel	3000 pieces					
Controlling dimension: millimeters						

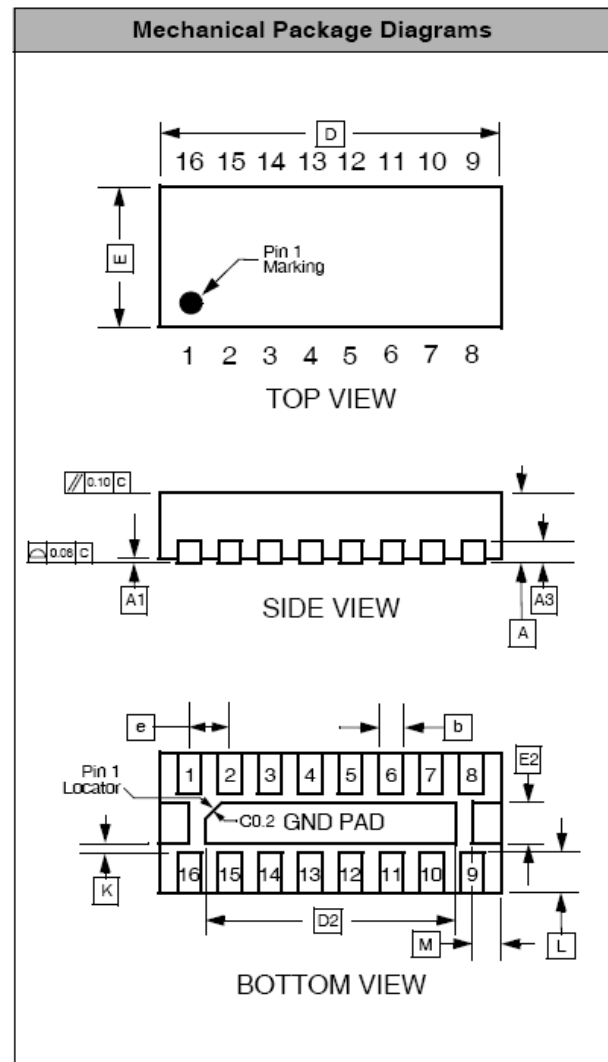

**Dimensions for 16-Lead, 0.5mm pitch TDFN package with Exposed End Pads (EEP)**

\*This package is compliant with JEDEC standard MO-229C with the exception of the "D", "D2", "E", "E2", "K" and "L" dimensions as called out in the table above.

ON Semiconductor and  are registered trademarks of Semiconductor Components Industries, LLC (SCILLC). SCILLC reserves the right to make changes without further notice to any products herein. SCILLC makes no warranty, representation or guarantee regarding the suitability of its products for any particular purpose, nor does SCILLC assume any liability arising out of the application or use of any product or circuit, and specifically disclaims any and all liability, including without limitation special, consequential or incidental damages. "Typical" parameters which may be provided in SCILLC data sheets and/or specifications can and do vary in different applications and actual performance may vary over time. All operating parameters, including "Typicals" must be validated for each customer application by customer's technical experts. SCILLC does not convey any license under its patent rights nor the rights of others. SCILLC products are not designed, intended, or authorized for use as components in systems intended for surgical implant into the body, or other applications intended to support or sustain life, or for any other application in which the failure of the SCILLC product could create a situation where personal injury or death may occur. Should Buyer purchase or use SCILLC products for any such unintended or unauthorized application, Buyer shall indemnify and hold SCILLC and its officers, employees, subsidiaries, affiliates, and distributors harmless against all claims, costs, damages, and expenses, and reasonable attorney fees arising out of, directly or indirectly, any claim of personal injury or death associated with such unintended or unauthorized use, even if such claim alleges that SCILLC was negligent regarding the design or manufacture of the part. SCILLC is an Equal Opportunity/Affirmative Action Employer. This literature is subject to all applicable copyright laws and is not for resale in any manner.

## PUBLICATION ORDERING INFORMATION

### LITERATURE FULFILLMENT:

Literature Distribution Center for ON Semiconductor  
P.O. Box 5163, Denver, Colorado 80217 USA  
**Phone:** 303-675-2175 or 800-344-3860 Toll Free USA/Canada  
**Fax:** 303-675-2176 or 800-344-3867 Toll Free USA/Canada  
**Email:** [orderlit@onsemi.com](mailto:orderlit@onsemi.com)

**N. American Technical Support:** 800-282-9855  
Toll Free USA/Canada  
**Europe, Middle East and Africa Technical Support:**  
Phone: 421 33 790 2910  
**Japan Customer Focus Center**  
Phone: 81-3-5773-3850

ON Semiconductor Website: [www.onsemi.com](http://www.onsemi.com)

Order Literature: <http://www.onsemi.com/orderlit>

For additional information, please contact your local Sales Representative