

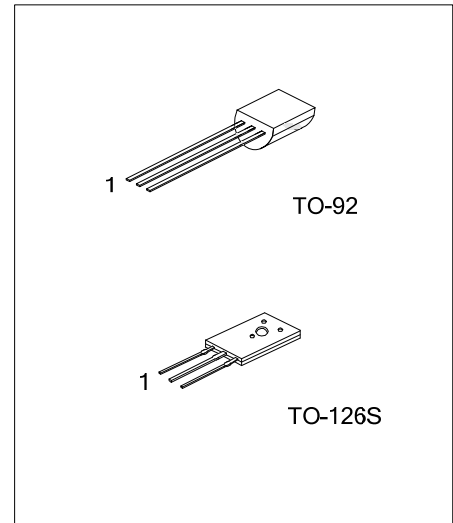

MJE13003-E

NPN EPITAXIAL SILICON TRANSISTOR

HIGH VOLTAGE
FAST-SWITCHING NPN
POWER TRANSISTOR



DESCRIPTION

The UTC **MJE13003-E** designed for use in high-voltage, high speed, power switching in inductive circuit. It is particularly suited for 115 and 220V switchmode applications such as switching regulator's, inverters, DC-DC converter, Motor control, Solenoid/Relay drivers and deflection circuits.

FEATURES

*Collector-Emitter Sustaining Voltage:

$V_{CE(sus)}=300V$.

*Collector-Emitter Saturation Voltage:

$V_{CE(sat)}=1.0V(\text{Max.}) @ I_C=1.0A, I_B=0.25A$

*Switch Time- $t_f=0.7\mu s(\text{Max.}) @ I_C=1.0A$.

ORDERING INFORMATION

Ordering Number		Package	Pin Assignment			Packing
Lead Free	Halogen Free		1	2	3	
MJE13003L-E-x-T6S-K	MJE13003G-E-x-T6S-K	TO-126S	B	C	E	Bulk
MJE13003L-E-x-T92-B	MJE13003G-E-x-T92-B	TO-92	B	C	E	Tape Box
MJE13003L-E-x-T92-K	MJE13003G-E-x-T92-K	TO-92	B	C	E	Bulk
MJE13003L-E-x-T92-A-B	MJE13003G-E-x-T92-A-B	TO-92	E	C	B	Tape Box
MJE13003L-E-x-T92-A-K	MJE13003G-E-x-T92-A-K	TO-92	E	C	B	Bulk

<p>MJE13003L-E-x-T92-A-B</p>	<p>(1) B: Tape Box, K: Bulk (2) refer to Pin Assignment (3) T6S: TO-126S, T92: TO-92 (4) x: refer to Classification of h_{FE1} (5) L: Lead Free, G: Halogen Free</p>
------------------------------	---

MARKING INFORMATION

PACKAGE	MARKING
TO-126S	
TO-92	

■ ABSOLUTE MAXIMUM RATINGS

PARAMETER		SYMBOL	RATINGS	UNIT
Collector-Emitter Voltage		$V_{CEO(SUS)}$	400	V
Collector-Emitter Voltage		V_{CEV}	700	V
Emitter Base Voltage		V_{EBO}	9	V
Collector Current	Continuous	I_C	1.5	A
	Peak (1)	I_{CM}	3	
Base Current	Continuous	I_B	0.75	A
	Peak (1)	I_{BM}	1.5	
Emitter Current	Continuous	I_E	2.25	A
	Peak (1)	I_{EM}	4.5	
Total Power Dissipation	$T_A=25^\circ\text{C}$	TO-92	1.1	W
		TO-126S	1.4	
	Derate above 25°C	TO-92	8	W/ $^\circ\text{C}$
		TO-126S	11.2	
	$T_C=25^\circ\text{C}$	TO-92	1.5	W
		TO-126S	20	
Derate above 25°C	TO-92	12	W/ $^\circ\text{C}$	
	TO-126S	160		
Junction Temperature		T_J	150	$^\circ\text{C}$
Storage Temperature		T_{STG}	-65 to +150	$^\circ\text{C}$

■ THERMAL CHARACTERISTICS

PARAMETER		SYMBOL	RATINGS	UNIT
Junction to Ambient	TO-92	θ_{JA}	113.6	$^\circ\text{C/W}$
	TO-126S		89	
Junction to Case	TO-92	θ_{JC}	80	$^\circ\text{C/W}$
	TO-126S		6.25	
Maximum Load Temperature for Soldering Purposes: 1/8" from Case for 5 Seconds		T_L	275	$^\circ\text{C}$

Note: 1. Pulse Test : Pulse Width=5ms,Duty Cycle≤10%

2. Designer 's Data for "Worst Case" Conditions – The Designer 's Data Sheet permits the design of most circuits entirely from the information presented. SOA Limit curves – representing boundaries on device characteristics – are given to facilitate "Worst case" design.

MJE13003-E

NPN EPITAXIAL SILICON TRANSISTOR

■ ELECTRICAL CHARACTERISTICS (T_C=25°C, unless otherwise specified)

PARAMETER	SYMBOL	TEST CONDITIONS	MIN	TYP	MAX	UNIT
OFF CHARACTERISTICS (1)						
Collector-Emitter Sustaining Voltage	V _{CEO(SUS)}	I _C =10 mA, I _B =0	400			V
Collector Cutoff Current	I _{CEV}	V _{CEV} =Rated Value, V _{BE(off)} =1.5 V			1	mA
		V _{CEV} =Rated Value, V _{BE(off)} =1.5V, T _C =100°C			5	mA
SECOND BREAKDOWN						
DC Current Gain	h _{FE1}	I _C =0.5 A, V _{CE} =2V	8		40	
	h _{FE2}	I _C =1 A, V _{CE} =2V	3		25	
	h _{FE3}	I _C =200mA, V _{CE} =10V	9		40	
Collector-Emitter Saturation Voltage	V _{CE(SAT)}	I _C =0.5A, I _B =0.1A			0.5	V
		I _C =1A, I _B =0.25A			2.5	
		I _C =1.5A, I _B =0.5A			3	
Base-Emitter Saturation Voltage	V _{BE(SAT)}	I _C =0.5A, I _B =0.1A			1	V
		I _C =1A, I _B =0.25 A			1.2	
DYNAMIC CHARACTERISTICS						
Current-Gain-Bandwidth Product	f _T	I _C =100mA, V _{CE} =10 V, f=1MHz	4	10		MHz
Output Capacitance	C _{ob}	V _{CB} =10V, I _E =0, f=0.1MHz		21		pF
SWITCHING CHARACTERISTICS (TABLE 1)						
Delay Time	t _d	V _{CC} =125V, I _C =1A, I _{B1} =I _{B2} =0.2A, t _p =25μs, Duty Cycle≤1%		0.05	0.1	μs
Rise Time	t _r			0.5	1	μs
Storage Time	t _s			2	4	μs
Fall Time	t _f			0.4	0.7	μs
INDUCTIVE LOAD, CLAMPED (TABLE 1, FIGURE 7)						
Storage Time	t _{sv}	I _C =1A, V _{clamp} =300V, I _{B1} =0.2A, V _{BE(off)} =5V, T _C =100°C		1.7	4	μs
Crossover Time	t _c			0.29	0.75	μs
Fall Time	t _{fi}			0.15		μs

■ CLASSIFICATION OF h_{FE1}

RANK	A	B	C	D	E	F
RANGE	8 ~ 16	15 ~ 21	20 ~ 26	25 ~ 31	30 ~ 36	35 ~ 40

APPLICATION INFORMATION

Table 1. Test Conditions for Dynamic Performance

Reverse Bias Safe Operating Area and Inductive Switching		Resistive Switching
Test Circuits		
Circuit Values	<p>Coil Data : GAP for 30 mH/2 A $V_{CC}=20V$ Ferroxcube core #6656 $L_{coil}=50mH$ $V_{clamp}=300V$ Full Bobbin (~ 200 Turns) #20</p>	<p>$V_{CC}=125V$ $R_C=125\Omega$ $D1=1N5820$ or Equiv. $R_B=47\Omega$</p>
Test Waveforms	<p>Output Waveforms OUTPUT WAVEFORMS</p> <p>t_1 Adjusted to Obtain I_C $t_1 = \frac{L_{coil}(I_{cpk})}{V_{cc}}$ $t_2 = \frac{L_{coil}(I_{cpk})}{V_{clamp}}$</p>	<p>$t_r, t_f < 10ns$ Duty Cycle=1.0% R_B and R_C adjusted for desired I_B and I_C</p>

Table 2. Typical Inductive Switching Performance

I_C (AMP)	T_C ($^{\circ}C$)	T_{SV} (μs)	T_{RV} (μs)	T_{FI} (μs)	T_{TI} (μs)	T_C (μs)
0.5	25	1.3	0.23	0.30	0.35	0.30
	100	1.6	0.26	0.30	0.40	0.36
1	25	1.5	0.10	0.14	0.05	0.16
	100	1.7	0.13	0.26	0.06	0.29
1.5	25	1.8	0.07	0.10	0.05	0.16
	100	3	0.08	0.22	0.08	0.28

Note: All Data Recorded in the inductive Switching Circuit Table 1

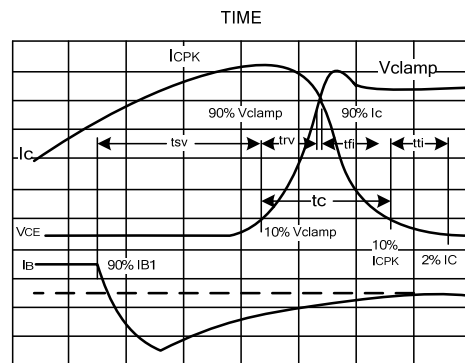

Fig 1. Inductive Switching Measurements

SWITCHING TIMES NOTE

In resistive switching circuits, rise, fall, and storage times have been defined and apply to both current and voltage waveforms since they are in phase. However, for inductive loads which are common to SWITCHMODE power supplies and hammer drivers, current and voltage waveforms are not in phase. Therefore, separate measurements must be made on each wave form to determine the total switching time. For this reason, the following new terms have been defined.

t_{sv} =Voltage Storage Time, 90% IB1 to 10% Vclamp

t_{rv} =Voltage Rise Time, 10-90% Vclamp

t_{fi} =Current Fall Time, 90-10% I_c

t_{ti} =Current Tail, 10-2% I_c

t_c =Crossover Time, 10% Vclamp to 10% I_c

An enlarged portion of the inductive switching waveforms is shown in Figure 1 to aid in the visual identity of these terms.

For the designer, there is minimal switching loss during storage time and the predominant switching power losses occur during the crossover interval and can be obtained using the standard equation from AN-222:

$$PSWT = 1/2 V_{cc} I_c (t_c) f$$

In general, $t_{rv} + t_{fi} \approx t_c$. However, at lower test currents this relationship may not be valid.

As is common with most switching transistor, resistive switching is specified at 25°C and has become a benchmark for designers. However, for designers of high frequency converter circuits, the user oriented specifications which make this a "SWITCHMODE" transistor are the inductive switching speeds (t_c and t_{sv}) which are guaranteed at 100°C.

RESISTIVE SWITCHING PERFORMANCE

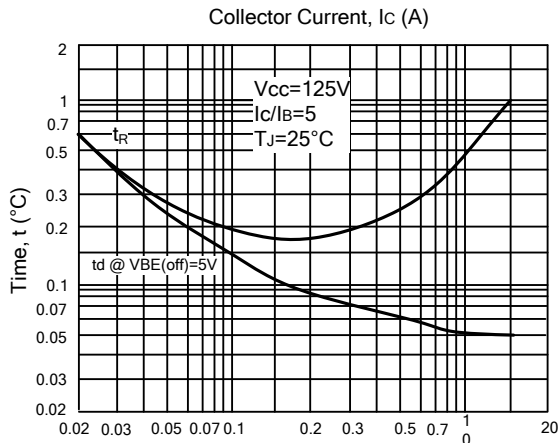

Fig 2. Turn-On Time

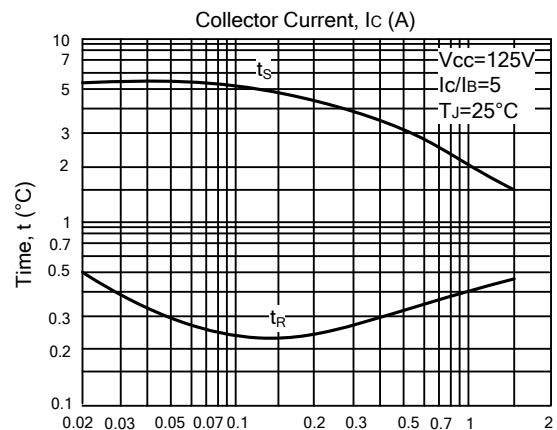

Fig 3. Turn-Off Time

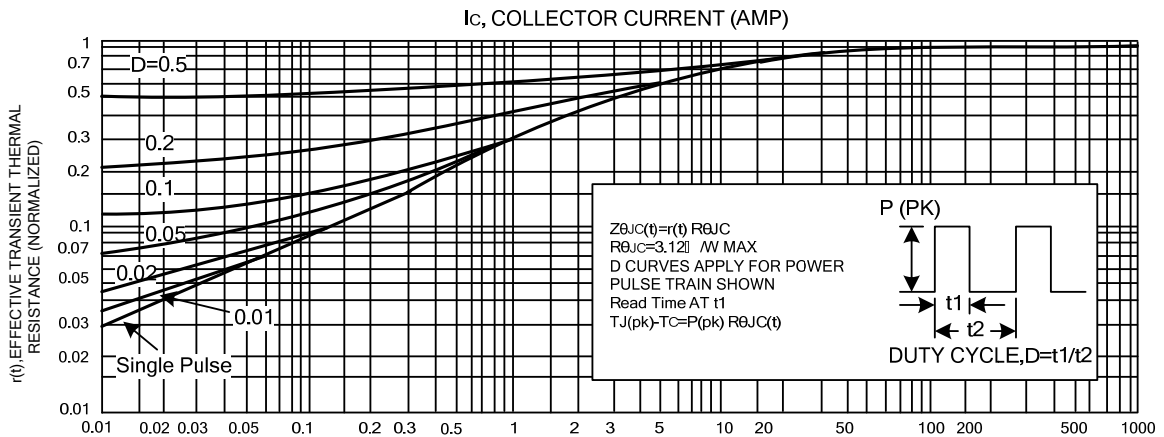

Fig 4. Thermal Response

■ SAFE OPERATING AREA INFORMATION

FORWARD BIAS

There are two limitations on the power handling ability of a transistor: average junction temperature and second break-down. Safe operating area curves indicate $I_c - V_{CE}$ limits of the transistor that must be observed for reliable operation; i.e., the transistor must not be subjected to greater dissipation than the curves indicate.

The data of Figure 5 is based on $T_c=25^\circ\text{C}$; $T_J(pk)$ is variable depending on power level. Second breakdown pulse limits are valid for duty cycles to 10% but must be derated when $T_c \geq 25^\circ\text{C}$. Second breakdown limitations do not derate the same as thermal limitations. Allowable current at the voltages shown on Figure 5 may be found at any case temperature by using the appropriate curve on Figure 7.

$T_J(pk)$ may be calculated from the data in Figure 5. At high case temperatures, thermal limitations will reduce the power that can be handled to values less than the limitations imposed by second breakdown.

REVERSE BIAS

For inductive loads, high voltage and high current must be sustained simultaneously during turn-off, in most cases, with the base to emitter junction reverse biased. Under these conditions the collector voltage must be held to a safe level at or below a specific value of collector current. This can be accomplished by several means such as active clamping, RC snubbing, load line shaping, etc. The safe level for these devices is specified as Reverse Bias Safe Operating Area and represents the voltage-current conditions during re-verse biased turn-off. This rating is verified under clamped conditions so that the device is never subjected to an avalanche mode. Figure 6 gives RBSOA characteristics.

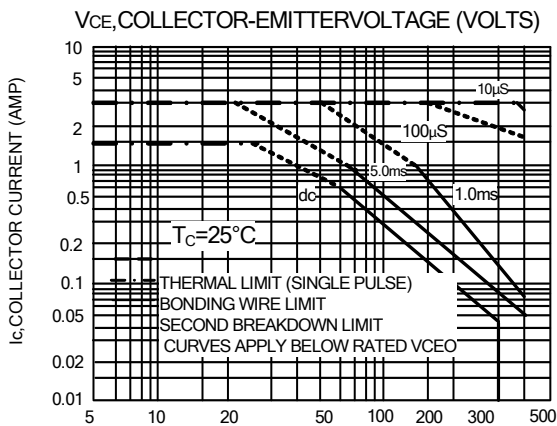

Fig 5. Active Region Safe Operating Area

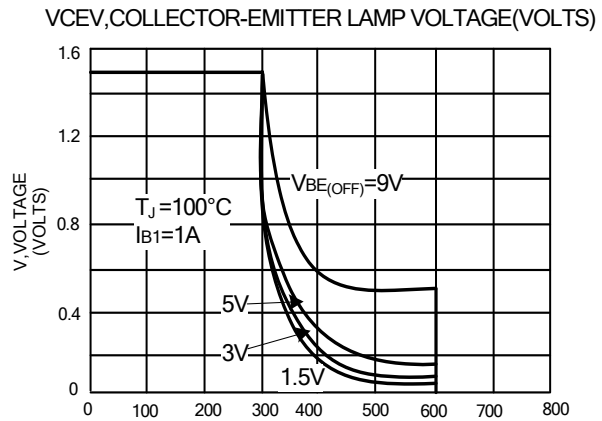

Fig 6. Reverse Bias Safe Operating Area

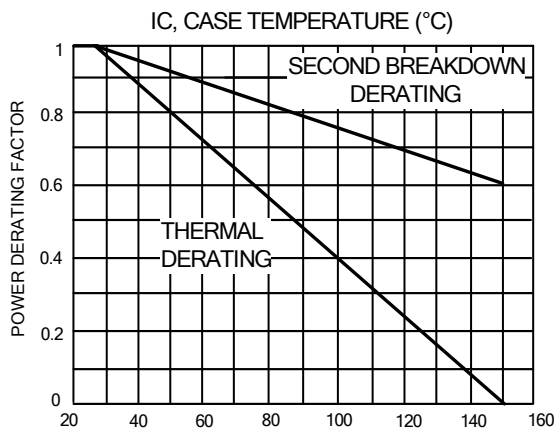
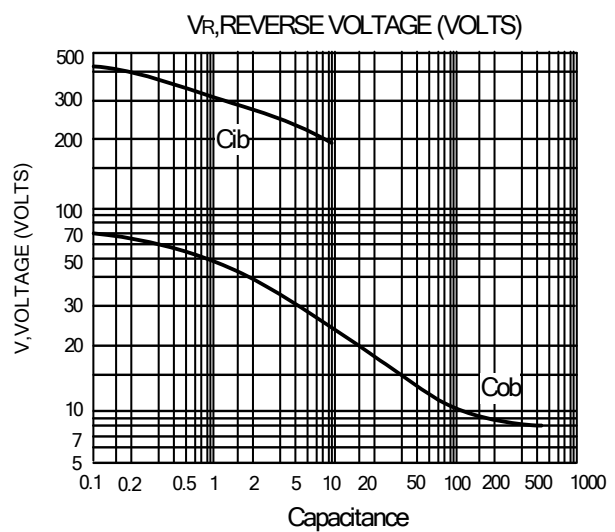
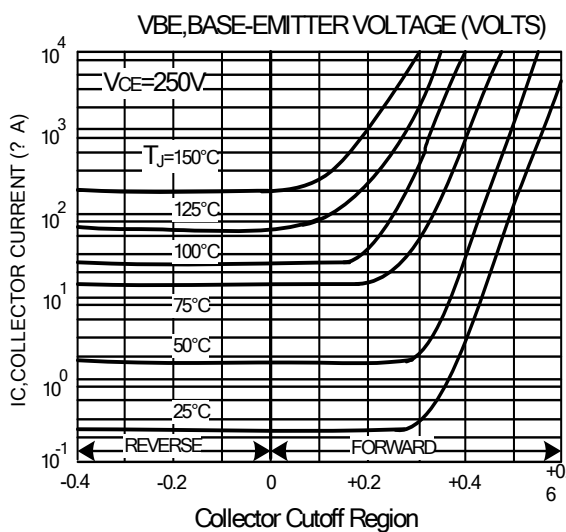
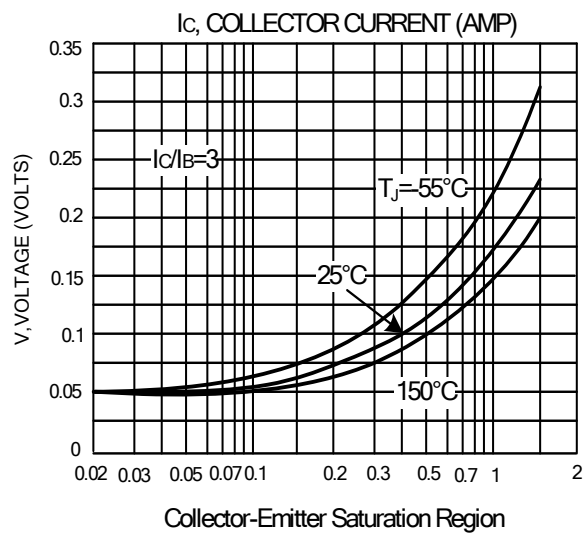
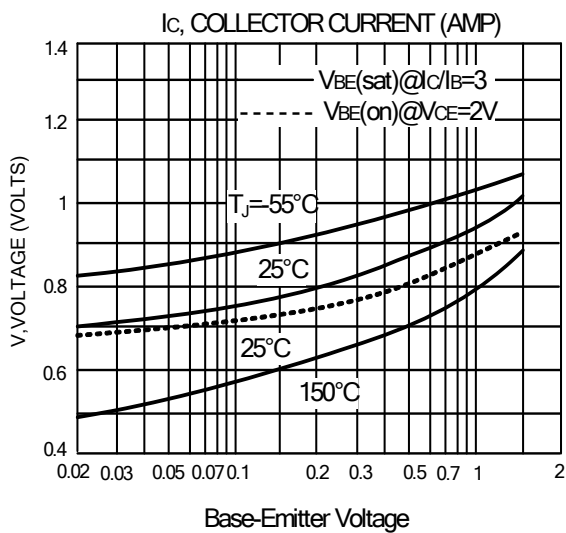
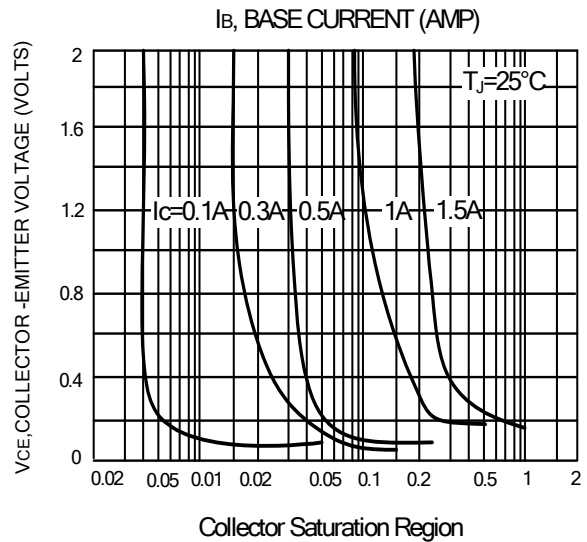
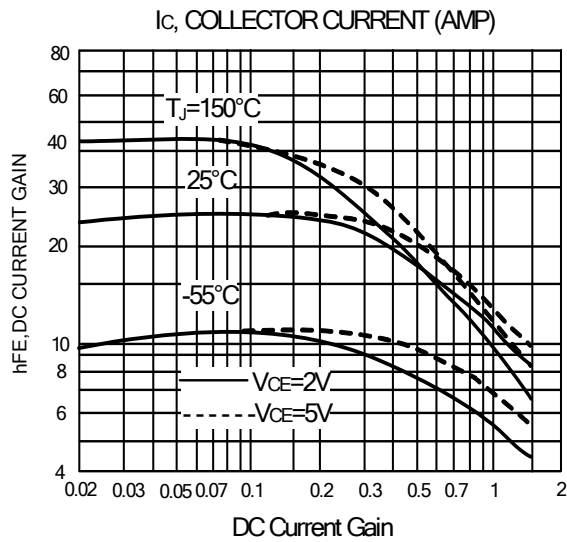

Fig 7. Forward Bias Power Derating

TYPICAL CHARACTERISTICS



UTC assumes no responsibility for equipment failures that result from using products at values that exceed, even momentarily, rated values (such as maximum ratings, operating condition ranges, or other parameters) listed in products specifications of any and all UTC products described or contained herein. UTC products are not designed for use in life support appliances, devices or systems where malfunction of these products can be reasonably expected to result in personal injury. Reproduction in whole or in part is prohibited without the prior written consent of the copyright owner. The information presented in this document does not form part of any quotation or contract, is believed to be accurate and reliable and may be changed without notice.